

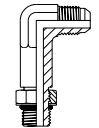

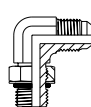

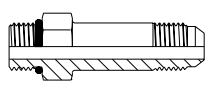

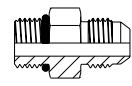

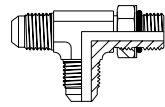
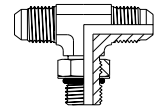
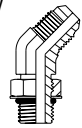
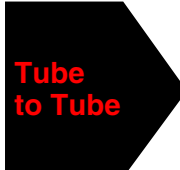
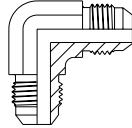
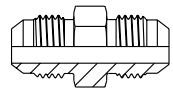
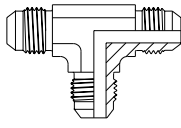
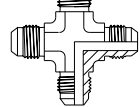
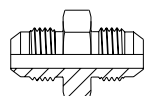

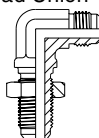
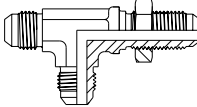
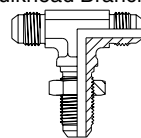
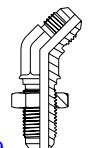
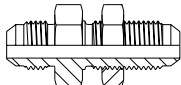
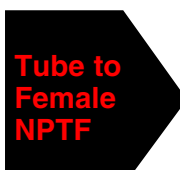
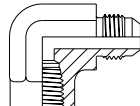
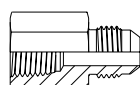
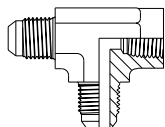
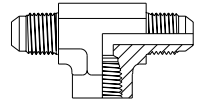
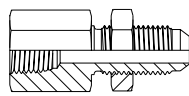

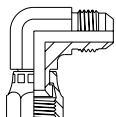
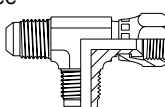
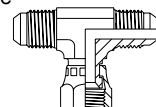
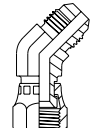

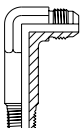
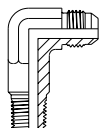
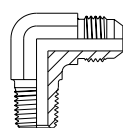
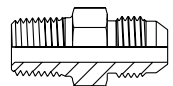
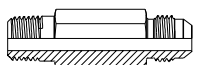
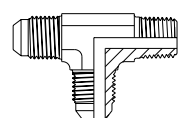
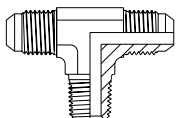
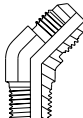
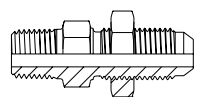
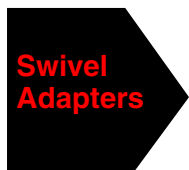
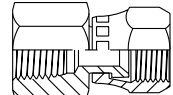
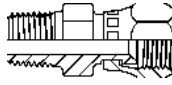
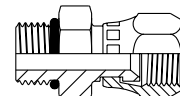
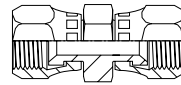
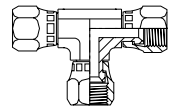
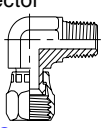

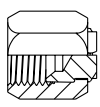
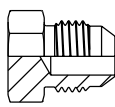
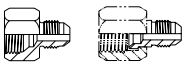
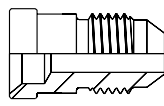
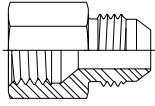

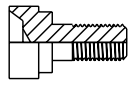

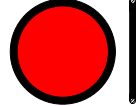
Triple-Lok® 37° Flared Tube Fittings

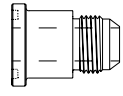
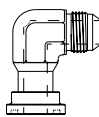
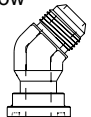

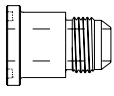
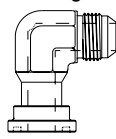
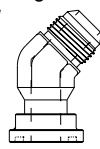

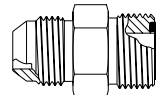
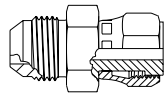
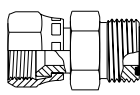

The Fitting Authority





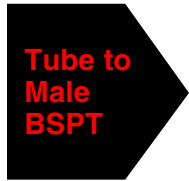
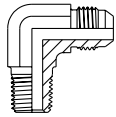
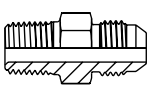
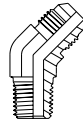

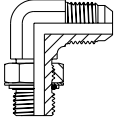
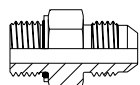
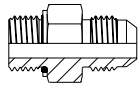
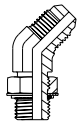
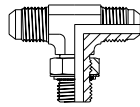
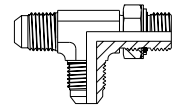

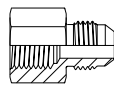
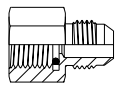

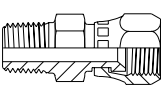
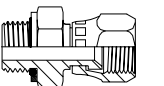
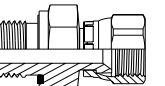
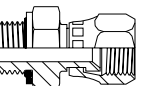
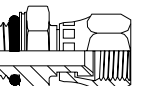
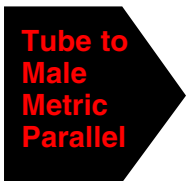
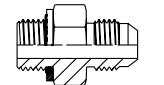
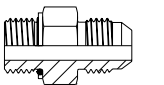
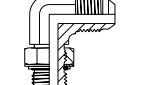
	<p>CC50X Long Straight Thread Elbow</p>  <p>Page C19</p>	<p>C50X Straight Thread Elbow</p>  <p>Page C20</p>	<p>FF50X Long Straight Thread Connector</p>  <p>Page C19</p>	<p>F50X Straight Thread Connector</p>  <p>Page C21</p>	<p>R50X Straight Thread Run Tee</p>  <p>Page C22</p>
<p>S50X Straight Thread Branch Tee</p>  <p>Page C22</p>	<p>V50X 45° Straight Thread Elbow</p>  <p>Page C23</p>		<p>ETX Union Elbow</p>  <p>Page C24</p>	<p>HTX Union</p>  <p>Page C26</p>	<p>JTX Union Tee</p>  <p>Page C25</p>
<p>KTX Union Cross</p>  <p>Page C25</p>	<p>LHTX Large Hex Union</p>  <p>Page C27</p>		<p>WETX Bulkhead Union Elbow</p>  <p>Page C27</p>	<p>WJTX Bulkhead Run Tee</p>  <p>Page C28</p>	<p>WJTX Bulkhead Branch Tee</p>  <p>Page C28</p>
<p>WNTX 45° Bulkhead Union Elbow</p>  <p>Page C29</p>	<p>WTX Bulkhead Union</p>  <p>Page C29</p>		<p>DTX Female Elbow</p>  <p>Page C30</p>	<p>GTX Female Connector</p>  <p>Page C31</p>	<p>MTX Female Run Tee</p>  <p>Page C32</p>
<p>OTX Female Branch Tee</p>  <p>Page C33</p>	<p>WGTX Female Bulkhead Connector</p>  <p>Page C32</p>		<p>C6X Swivel Nut Elbow</p>  <p>Page C34</p>	<p>R6X Swivel Nut Run Tee</p>  <p>Page C34</p>	<p>S6X Swivel Nut Branch Tee</p>  <p>Page C35</p>
<p>V6X 45° Swivel Nut Elbow</p>  <p>Page C35</p>		<p>CCCTX Extra Long Male Elbow</p>  <p>Page C36</p>	<p>CCTX Long Male Elbow</p>  <p>Page C36</p>	<p>CTX Male Elbow</p>  <p>Page C37</p>	<p>FTX Male Connector</p>  <p>Page C38</p>
<p>FFTXX Long Male Connector</p>  <p>Page C39</p>	<p>RTX Male Run Tee</p>  <p>Page C39</p>	<p>STX Male Branch Tee</p>  <p>Page C40</p>	<p>VTX 45° Male Elbow</p>  <p>Page C41</p>	<p>WFTX Male Bulkhead Connector</p>  <p>Page C42</p>	
	<p>G6X Swivel Connector</p>  <p>Page C43</p>	<p>F6X Swivel Connector</p>  <p>Page C42</p>	<p>F65OX/F65OMX Swivel Straight Thread Connector</p>  <p>Page C45</p>	<p>HX6 Swivel Nut Union</p>  <p>Page C44</p>	<p>JX6 Swivel Nut Union Tee</p>  <p>Page C44</p>

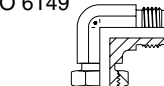
X6EF Swivel Elbow Connector  Page C45		BTX Nut  Page C46	FNTX Cap  Page C46	PNTX Plug  Page C47	TRTXN Tube End Reducer with Large Nut  Page C50
TRTX Tube End Reducer  Page C49	XHX7 Tube Extender/Orifice Connector  Page C48	TX Inch Sleeve  Page C51	T22X Mountie  Page C47	WLN Bulkhead Locknut  Page C51	SAE O-Ring Straight Thread Port O-Ring  Page B45
	XHQ1 Code 61 Flange Connector  Page J14	XEQ1 Code 61 Flange Elbow  Page J15	XVQ1 Code 61 Flange 45° Elbow  Page J16		
	XHQ2 Code 62 Flange Connector  Page J14	XEQ2 Code 62 Flange Elbow  Page J15	XVQ2 Code 62 Flange 45° Elbow  Page J16		
	XHLO 37° Male x ORFS Male Adapter  Page B36	XHL6 37° Male x ORFS Swivel Adapter  Page B37	LOHX6 37° Swivel x Male ORFS Adapter  Page B36	XHBU 37° Male x Male SAE Flareless (Ferulok) Adapter  Page D26	

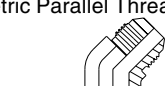

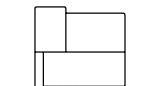
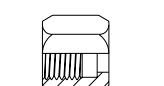
Metric/BSP Triple-Lok Tube Fittings (Shown in Section I)

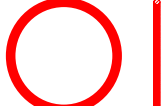
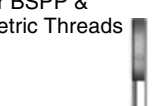
	C3MX Male Elbow BSPT  Page I45	F3MX Male Connector BSPT  Page I46	V3MX Male 45° Elbow BSPT  Page I47		C40MX Male Elbow BSPP  Page I48
F40MX Male Connector BSPP  Page I52	F42EDMX Male Connector BSPP  Page I53	V40MX Male 45° Elbow BSPP  Page I54	S40MX Male Branch Tee BSPP  Page I54	R40MX Male Run Tee BSPP  Page I55	
	G4MX Female Connector BSPP  Page I55	G4MXMO Manometer Connection BSPP  Page I49			

Metric/BSP Triple-Lok Tube Fittings (cont'd.)					
 <p>Swivel Nut</p>	<p>F63MX 37° Swivel to Male BSPT</p>  <p>Page I49</p>	<p>F64OMX 37° Swivel to Male BSPP</p>  <p>Page I50</p>	<p>F642EDMX 37° Swivel to Male BSPP</p>  <p>Page I50</p>	<p>F68OMX 37° Swivel to Male Metric Parallel Thread</p>  <p>Page I51</p>	<p>F687OMX 37° Swivel to ISO 6149</p>  <p>Page I51</p>
	 <p>Tube to Male Metric Parallel</p>	<p>F80MX Male Connector-Metric Parallel Thread</p>  <p>Page I56</p>	<p>F82EDMX Male Connector-Metric Parallel Thread</p>  <p>Page I57</p>	<p>C80MX Male Elbow Metric Parallel Thread</p>  <p>Page I59</p>	
 <p>Tube to ISO 6149</p>		<p>C870MX Male Elbow ISO 6149</p>  <p>Page I60</p>	<p>F870MX Male Connector ISO 6149</p>  <p>Page I58</p>	<p>V870MX Male 45° Elbow Metric Parallel Thread</p>  <p>Page I60</p>	
	 <p>Auxiliary Components</p>	<p>TX Sleeve</p>  <p>Page I61</p>	<p>BTX Nut</p>  <p>Page I62</p>	<p>RR Metric Retaining Ring</p>  <p>Page I64</p>	<p>BSPP Retaining Ring</p>  <p>Page I63</p>
<p>BSPP O-Ring</p>  <p>Page I63</p>		<p>ED EOlastic Soft Seal for BSPP & Metric Threads</p>  <p>Page H123</p>	<p>ISO 6149 Metric Straight Thread Port O-Ring</p>  <p>Page I35</p>		

Introduction

The concept of flaring tube to provide a seal and holding power to the connection is very old. Its origin goes back to the early days of the automobile. Different types of flared connections including 45° single and double flares, inverted flare, 30° flare, etc., were developed for coolant, fuel, brake and lube systems of the early automobile.

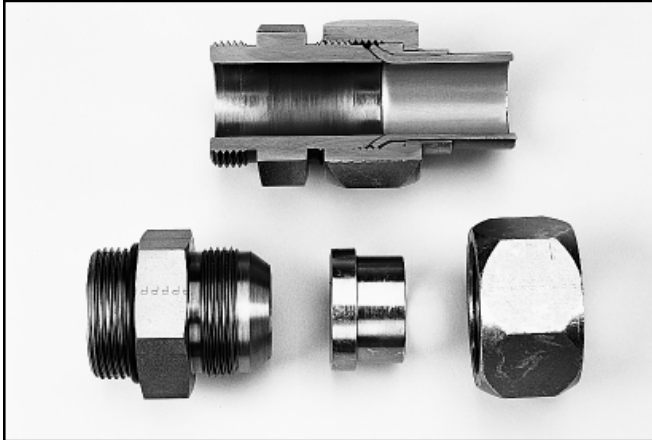

Fig. C1 — Triple-Lok fitting components (fitting body with O-ring, sleeve and nut) and assembled Triple-Lok fitting cutaway

Pioneered by Parker Hannifin, Triple-Lok (37° flare fitting) evolved as a higher pressure version of the above connections. Its initial use was in the developing hydraulic systems of agricultural and earth moving machinery, automotive transfer lines, and other machine tools.

As exports of machinery increased after World War II, the Triple-Lok fitting gained worldwide use and acceptance. Today, it is the most widely used fitting in the world. It enjoys conformance approvals by a wide range of national and international technical and certifying organizations listed on [page C6](#).

Its appeal is in its simplicity, compact design, ease of assembly, reliability (single seal), wide availability and acceptance. It is especially suited for low and medium wall tubing. Even though it is generally considered to be a 3000 psi fitting, its capabilities range from 5000 psi for 1/8" size to 1500 psi for 2" size. Currently, it is used in virtually every application that uses fluid power for motion control.

Design and Construction

The Triple-Lok (the 37° flare fitting) design is very simple. It uses an easily produced flare at the tube end to seal and hold fluid under high pressure. The fitting consists of three pieces: the body, sleeve and nut. The tube end is flared at a 37° angle and held between the fitting nose (seat) and the sleeve (support) with the nut as shown in [Fig. C1](#), providing a very effective (single) seal between the fitting nose and the tube flare.

The support sleeve serves several important functions:

1. It provides a clamping surface for the tube flare and bearing shoulder for the nut. This minimizes tube twisting during assembly.
2. It provides support to the flare. The tapered fitting nose tends to wedge open the flare during assembly. The sleeve helps resist this expansion, allowing the fitting to be torqued adequately.
3. It makes the fitting adaptable to metric tubing merely by changing the I.D. of the sleeve. This feature has made the fittings acceptable worldwide.

The design is also very efficient. It has the smallest seal area of all fitting designs. The seal area, as seen in [Fig. C2](#), is only slightly larger than the fluid flow area. The small seal area results in compact design, low assembly torque and high (pressure) holding power for the joint.

The design was standardized initially as a JIC (Joint Industrial Council) design and was later adopted by the SAE (Society of Automotive Engineers) and ISO (International Standards Organization) to assure complete dimensional interchangeability between various manufacturers.

Even though all manufacturers conform to the same dimensional standard, there are significant difference in performance of the fittings because of a variety of methods of manufacture and quality standards used.

Triple-Lok fitting components are produced using the best methods of manufacture and state-of-the-art equipment to assure construction integrity, high strength, long service life and high quality.

The Triple-Lok Body. Straight bodies are made from either cold drawn bar stock or cold formed construction. All shapes are of one piece forged construction eliminating potential leak paths of multiple component constructions such as brazed shapes. The Triple-Lok steel forged shapes also feature higher hardness for high pressure capability and minimal nose collapse (typical of sizes -10 and under) during repeated assembly.

The Triple-Lok Sleeve. Triple-Lok fitting support sleeves are cold formed and heat treated for an optimum combination of strength and ductility. Cold forming also eliminates the problems of laps, folds, stringers, etc., associated with sleeves machined from bar stock.

The Triple-Lok Nut. Nuts for all but the three largest sizes (-20, -24 and -32) are cold formed. Cold forming increases material strength and its fatigue properties, imparting high strength and longer service life to the nuts.

Larger nuts, which are less severely stressed, are made from cold drawn bar stock.

Standard Material Specification. The standard materials used in the manufacture of Triple-Lok fittings are shown in [Table C1](#).

C

Triple-Lok Fittings	Steel		Brass		Stainless Steel	
	ASTM	Type	ASTM	Type	ASTM	Type
Cold Formed Bodies	A576	C1010/C1008	—	—	—	—
Forged Bodies	A576	1214/1215	B124	CA377	A182	316
Bar Stock Bodies	A108	12L14	B16 B453	CA360 CA345	A479	316
Cold Formed Nuts	A576	C1010/C1008	B121	CA335	A276	316
Bar Stock Tube Nuts	A108	12L14	B16	CA360	A479	316
Cold Formed Tube Sleeves	SAE 1020		B111	CA443 CA444	—	—
Bar Stock Sleeves	A108	C1137	B371	CA694	A479	316

Table C1 — Standard Material Specifications for Triple-Lok Fittings

Note: On request, Triple-Lok fittings can be furnished in materials other than those shown above.

Finish: Zinc with yellow chromate is used on all standard steel products. Stainless steel fittings are passivated.

Conformance Standards

Approvals

Triple-Lok fittings are approved, for use as indicated, by the following organizations:

Bureau Veritas — Approved for use in hydraulic systems up to size 38mm O.D. tubing as shown on certificate number 2190 1907D00H for steel Triple-Lok products.

Det Norske Veritas — Approved for use in hydraulic systems up to size 38mm O.D. as shown on certificate no. P-9085/792-22 for steel and stainless steel Triple-Lok.

Germanischer Lloyd — Approved for use in piping systems on board ships, off-shore units, on-shore installations, and in machinery installations as shown on certificate number 9672890 HH.

U.S. Coast Guard — Approved for use in hydraulic systems on all Coast Guard vessels as shown on certificate 16703/46 CFR 56.60.

U.S.S.R. Register of Shipping — Triple-Lok fittings are accepted for piping on ships as shown on certificate no. 93.017.260.

Specifications

Triple-Lok fittings meet the following specifications as described:

ASME/ANSI-B31.1 Code for Power Piping — Triple-Lok fittings meet the design safety requirements and material strength codes outlined in ASME-B31.1.

British Standard - BS4368 Part 4 — Test requirements for compression couplings for tubes. Meets all requirements of BS4368 Part 4, as called for by Lloyds Register of Shipping.

Military Specification - MIL-F-18866 — Some Triple-Lok parts conform to the requirements of specification sheets MS515XX under MIL-F-18866, and others do not. Please [contact the Tube Fittings Division](#) for conformance details.

Note: The aforementioned specification is approved for use by all departments and agencies of the Department of Defense for **non-aircraft** applications including ground support equipment. Triple-Lok fittings meet SAE J514, while the MS515XX specification

sheets may not have maintained industry compliance with SAE J514. This is why some of the Triple-Lok parts do not conform to the MS requirements. The U.S. military and SAE are currently in negotiations that will allow the military to fully adopt SAE J514 conforming parts and obsolete the Military Specification.

AN/AND Standards Conformance — AN (Air Force–Navy Aeronautical Standard) and AND (Air Force–Navy Aeronautical Design Standard) are standards used for general, military and commercial aircraft/aviation applications. While AN/AND flare fittings and Parker Triple-Lok appear to be functionally interchangeable **they are not**. Parker Triple-Lok fittings **may not be substituted** for AN/AND fittings applications. [Contact Parker Tube Fittings Division](#) for more information.

SAE J514 — Steel (carbon and stainless) Triple-Lok fittings meet all design and performance requirements for 37° flare tube fittings in J514 published by the Society of Automotive Engineers.

NFPA T3.8.3 — Hydraulic Tube Fitting Tests — Meets all performance requirements of the National Fluid Power Association (NFPA) specification, formerly covered under JIC (Joint Industrial Council) standard.

ISO 8434-2 — Connections for tubes and hoses — Meets all requirements for 37° flare fittings.

How Triple-Lok Fittings Work

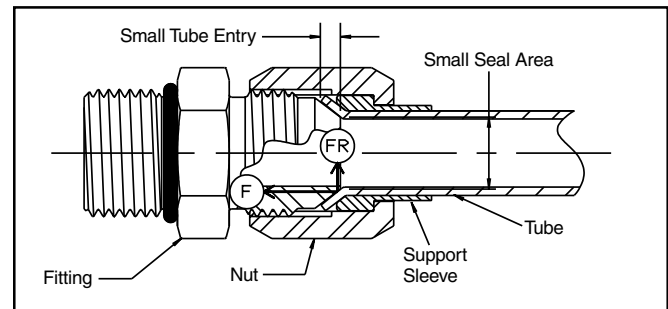

Fig. C2 — Triple-Lok Fitting Features

As seen in [Fig. C2](#), torquing of the nut clamps the tube flare against the body nose (seat) producing a leak tight joint. This clamping on the 37° taper provides a measure of elasticity to the joint helping it to resist loosening under vibration. The clamping force results in a small radial load (F_R) that tends to deform the fitting nose radially. The resistance of the nose to elastic deformation provides a constant preload (similar to a lockwasher) keeping it tight.

The clamping force provided by the nut resists the opposing force of the fluid under pressure. The joint remains leak tight as long as the clamping force is higher than the opposing pressure load. Properly assembled Triple-Lok fittings with appropriate tube will seal consistently under pressure until tube bursts.

Sealing in Triple-Lok fittings takes place between two smooth metal surfaces, the fitting nose and inside of the tube flare. Therefore, the sealing surfaces have to be round and smooth, free of any nicks, scratches, spiral tool marks, splits or weld beads, in the seal area.

Seamless or welded and drawn fully annealed tubing is recommended for Triple-Lok fittings for ease in flaring and bending. For specific tube type and wall thickness recommendations, please see [Table C4](#).

Assembly

Triple-Lok fitting assembly consists of the following simple steps: 1.) cutting, deburring and cleaning the tube, 2.) flaring, and 3.) assembly or installation.

Caution: Use only seamless or welded and drawn tubing that is fully annealed for flaring and bending. (See Table A27 for tube/fitting material compatibility information.)

Cutting, Deburring and Cleaning

Cut tubing reasonably square (within +/- 1 degree) using a circular toothed cut-off saw as shown in Fig. C3, or a hacksaw with a fine tooth blade (Fig. C4). A tube cutter may be used with soft tubing such as copper and aluminum. (It is not recommended for steel and stainless steel tubing.) Use Parker Tru-Kut sawing vise with hacksaw for a square cut as shown in Fig. C4.

Lightly deburr the I.D. and O.D. of the tube end to remove burrs and sharp edges. Use IN-EX deburring tool (see page N6) or emery paper if using tube cutter or hacksaw. Use front mounted deburring tools if using TP432 or TP1025 tube preparation center, as shown in Fig. C5.

Flaring

Several flaring methods, ranging from simple hand flaring to hydraulic/electric power flaring, are available. Various tools for flaring are shown on pages N30 through N36. Power flaring is quicker and produces more accurate and consistent flares compared to hand flaring. Therefore, it is a preferred method of flaring. Hand flaring should be limited to places where power flaring tools are not readily available. The Parflange machines also flare tubing with an orbital flaring process and provide the best flare for stainless steel tubing.

Step 1

Remove metal chips from I.D. with a brush or compressed air. Wipe the I.D. and the O.D. of the deburred tube end with a clean rag. Proper cleaning of the tube end before flaring is a must to keep metal chips and dirt from embedding in the flared surface and causing potential leak paths.

Note: Point tube end downward during deburring to keep chips from entering the tube.

Step 2

Flare tube end using one of the flaring tools and following its operating instructions. Fig. C7 shows flaring with Hydra-Tool.

Note: Be sure to insert a nut and a sleeve in proper sequence and orientation before flaring either end of a bent tube, or second end of a straight tube as shown in Figure C6.

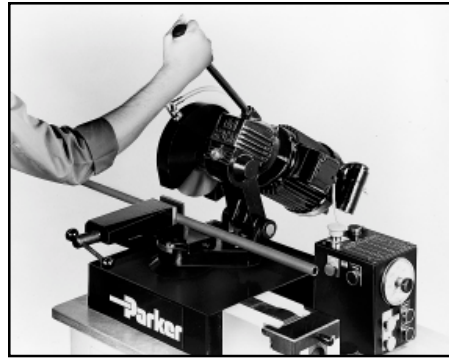

Fig. C3 — Cut-off saw on Parker's TP432 or TP1025 Tube Preparation Center

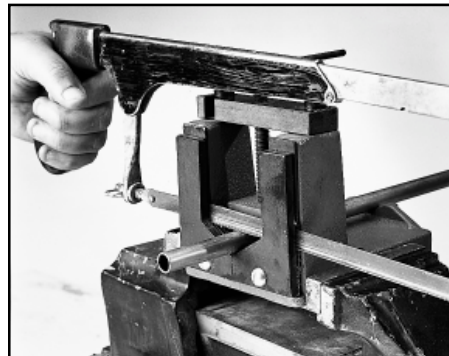

Fig. C4 — Parker's Tru-Kut sawing vise used with hacksaw



Fig. C5 — Deburring on TP432 or TP1025

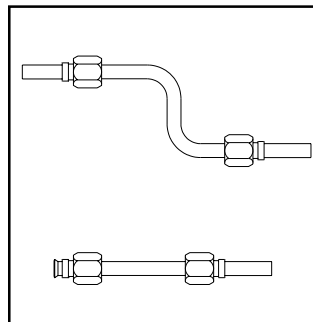

Fig. C6 — Components assembled before flaring



Fig. C7 — Flaring with Hydra-Tool

C

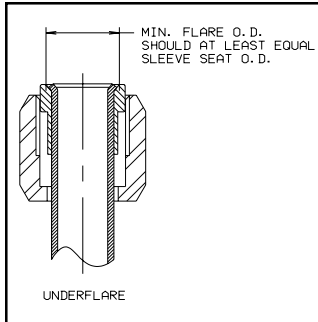

Fig. C8 — Underflare

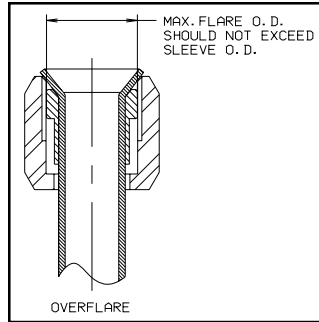

Fig. C9 — Overflare

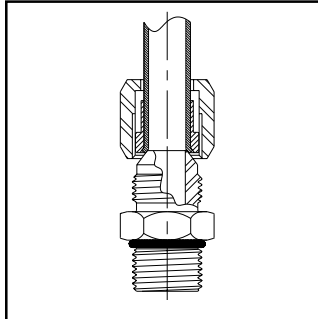

Fig. C10 — Underflared Assembly

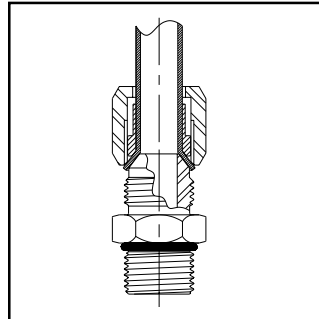

Fig. C11 — Overflared Assembly

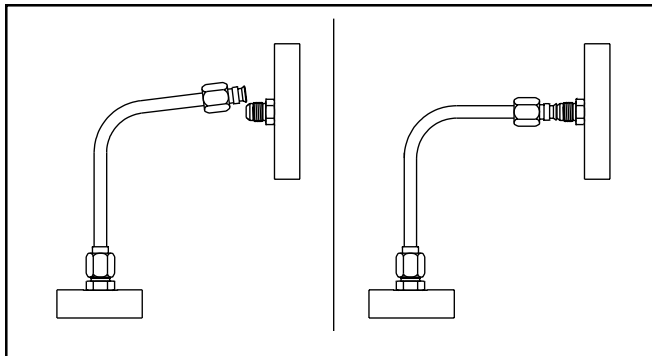

Fig. C12 — Align the tube with proper bend

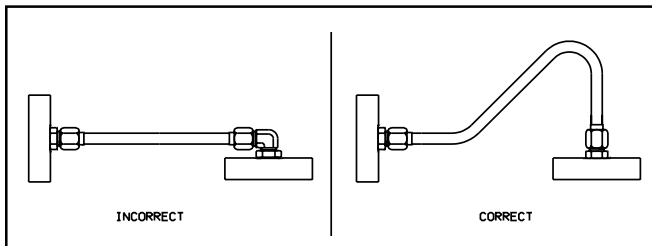

Fig. C13 — Use "S" bends to compensate for small variations in the tube length

Step 3

Inspect flare for dimensions and surface quality. The sleeve can be used for a quick check of the flare dimensions as shown in [Figs. C8 and C9](#).

Underflaring reduces contact area causing excessive nose collapse and leakage; or, in extreme cases, tube pull out under pressure ([Fig. C10](#)).

Overflaring causes tube nut thread interference, either preventing assembly altogether, or giving a false sense of joint tightness resulting in leakage ([Fig. C11](#)).

The flare must be reasonably square and concentric with the tube O.D.; and its surface must be smooth, free of rust, scratches, splits, weld beads, draw marks, embedded chips, burrs or dirt.

If the flare does not meet the above requirements, cut it off, determine the probable cause from the troubleshooting guide shown in [Table C5](#), take corrective action and re-flare.

Installation

Over half of the leakage with flared fittings is caused by improper flaring or installation. Thus, proper installation is critical for a trouble free operation.

Align tube flare against nose of fitting body and tighten the nut, hand tight (approximately 30 in. lb.), clamping the tube flare between the nose and sleeve.

Note: Do not force improperly bent tube into alignment or draw-in too short a tube using the nut. It puts undesirable strain on the joint leading, eventually, to leakage. One would not force the improperly bent tube as shown in [Fig. C12](#) into place.

Tighten the joint using one of the two methods described below:

The two methods are:

1. The flats from finger tight (F.F.F.T.) method, and
2. The torque method.

In the F.F.F.T. method the joint is tightened a given number of nut flats starting from a finger tight (snug) position. In the torque method, the nut is tightened (without lubrication) to a given torque.

The F.F.F.T. method is more forgiving of the two. It circumvents the effects of plating differences, lubrication, surface finishes, etc., that greatly influence the torque required to achieve proper joint tightness and clamping load. Therefore, Parker recommends the F.F.F.T. method wherever possible, and especially where plating combination is not known, and during maintenance and repair where the components may be oily. Use [Table C2](#) as a guide for proper tightening method.

Condition	Recommended Tightening Method
1. Plating of all components is the same.	Either method is acceptable. Use Table C3 .
2. Plating is mixed.	Use F.F.F.T. method.
3. Plating of nut and sleeve or hose end is unknown.	Use F.F.F.T. method.
4. Parts are oily.	Use F.F.F.T. method.
5. Stainless or brass components.	Use F.F.F.T. method.

Table C2 — Joint Tightening Method Guide

Flats From Finger Tight (F.F.F.T.) Method

After hand tightening the joint snug (approximately 30 in. lb.), make a longitudinal mark on one of the flats of the nut hex and continue it on to the body hex with a permanent type ink marker as shown in [Fig. C14](#). Then tighten the joint further by the number of flats from [Table C3](#). Now mark the body hex opposite the displaced mark on the nut hex as shown in [Fig. C15](#).

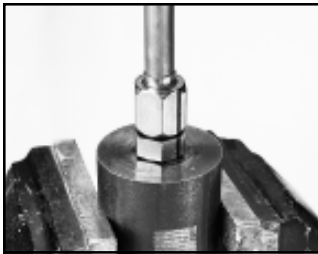

Fig. C14 — Hand tight positioned with initial mark



Fig. C15 — Fully tightened positioned with displaced mark

These marks serve two important functions.

1. Displaced marks serve as a quick quality assurance check that the joint has been reference tightened.
2. Second mark on the body serves as a proper tightening position after a joint has been loosened.

This method is slower than the torque method — but it has two distinct advantages over the torque method.

1. It eliminates the problems associated with different plating combinations.
2. It provided a very quick visual check for proper joint tightening.

Torque Method

Tighten the joint until appropriate torque value is reached. This method is fast and accurate when preset torque wrenches are used. This makes it desirable for high production assembly lines. However, a joint made up this way can only be checked for proper tightening by torquing it again.

Note: This method should *not* be used if type of plating on the fitting and mating part (sleeve and nut or hose end) is not known. The torque method should not be used for lubricated or oily parts. Improper clamping forces may result.

SAE Dash Size	Thread Size	Assembly Torque* (+10% -0)		Tube Connection F.F.F.T.	Swivel Nut or Hose Connection F.F.F.T.
		in. lb.	ft. lb.		
-2	5/16-24	35	2	—	—
-3	3/8-24	65	5	—	—
-4	7/16-20	130	11	2	2
-5	1/2-20	165	14	2	2
-6	9/16-18	235	20	1 1/2	1 1/4
-8	3/4-16	525	43	1 1/2	1
-10	7/8-14	650	55	1 1/2	1
-12	1 1/16-12	950	80	1 1/4	1
-14	1 3/16-12	1200	100	1	1
-16	1 5/16-12	1400	115	1	1
-20	1 5/8-12	1900	160	1	1
-24	1 7/8-12	2250	185	1	1
-32	2 1/2-12	3000	250	1	1
-40	3-12	—	—	1	1

Table C3 — Triple-Lok Fitting Assembly Torques and F.F.F.T.

Notes:

- *1. Assembly Torque — Torque values are for **unlubricated** carbon steel components. For brass fittings, use approximately 65% of the torque values shown, unlubricated. For stainless steel, a lubricant such as Permatex Anti-Seize Lubricant is recommended to prevent galling.
2. F.F.F.T. — The flats from finger tight assembly method is recommended for steel, stainless steel and brass components.
3. F.F.F.T. — For stainless steel components, suitable lubricant applied to contacting surfaces is recommended. Permatex Anti-Seize Lubricant is recommended.
4. F.F.F.T. = Flats (nut) from finger tight. In this reference position, tube flare or angular female surface of swivel connector must be seated and in light contact with 37° male surface (nose) of fitting body. **If necessary, a wrench should be used to pull nut and seats to this initial reference position.** For final assembly, the nut should now be tightened to the appropriate number of F.F.F.T. as shown in chart. Where necessary, a second wrench should be used to prevent unwanted rotation of fitting body, hose connector stem, etc.
5. Assembly Torque & F.F.F.T. — Torques and F.F.F.T. shown in the chart are for use with the tube materials, wall thicknesses, etc. recommended by Parker for use with Triple-Lok fittings.

How Triple-Lok is Used with Metric Tube Sizes

See [page I41](#) for a complete discussion on how the Triple-Lok connection can be used both with Imperial-sized (inch) or metric-sized tube.

Technical Data

Tube Wall Thickness, Inch and Metric

Fitting Dash Size	Wall Thickness When Using Inch Tubing		Wall Thickness When Using Metric Tubing	
	O.D. Inch	Wall Thickness Inch	O.D. mm	Wall Thickness mm
-2	1/8	0.010 – 0.035	–	–
-3	3/16	0.010 – 0.035	–	–
-4	1/4	0.020 – 0.065	6.0	0.5 – 2.0
-5	5/16	0.020 – 0.065	8.0	0.5 – 2.0
-6	3/8	0.020 – 0.065	10.0	0.5 – 2.0
-8	1/2	0.028 – 0.083	12.0	1.0 – 2.0
-10	5/8	0.035 – 0.095	14.0	1.0 – 2.5
-10	5/8	0.035 – 0.095	15.0	1.0 – 2.5
-10	5/8	0.035 – 0.095	16.0	1.0 – 2.5
-12	3/4	0.035 – 0.109	18.0	1.0 – 3.0
-12	3/4	0.035 – 0.109	20.0	1.0 – 3.0
-14	7/8	0.035 – 0.109	22.0	1.0 – 3.0
-16	1	0.035 – 0.120	25.0	1.0 – 3.0
-20	1 1/4	0.049 – 0.120	30.0	1.5 – 3.0
-20	1 1/4	0.049 – 0.120	32.0	1.5 – 3.0
-24	1 1/2	0.049 – 0.120	38.0	1.5 – 3.0
-32	2	0.058 – 0.134	50.0	1.5 – 3.5

Table C4 — Recommended “Min./Max” Tube Wall Thickness for Triple-Lok

Trouble Shooting Guide

Problem/Probable Causes	Remedy
Leakage at Triple-Lok End:	
Tube Misalignment or improper fit	Align the flared tube end and the connecting tube fitting before tightening the tube nut. Ensure that the tubing is bent to the appropriate bend angles. Do not “force” the tube assembly in to position. Use two wrenches during assembly.
Improper tightening	Check the joint for appropriate tightness. Retorque or use the flats from finger tight method of assembly to ensure appropriate joint make-up. If leakage persists, it could be a problem listed below.
Tube cracked along flare	Poor quality tubing, work-hardened tubing, or faulty tube preparation can cause the tube to crack. Re-flare while addressing the aforementioned issues. Do not use a tube cutter with steel and stainless steel tubing, as tube cutters tend to “work harden” the tubing before flaring.
Tube sealing surface has imperfection causing leakage between tube fitting and tube flare	Low quality welded tubing often will leave a weld bead causing a leak path between the fitting and tube flare. Use a high quality seamless or welded & redrawn type of tubing. Problems with the flaring tooling can also cause a surface imperfection on the tube flare as well. Flare cones/burnishing heads, when damaged can cause these imperfections in the mating tube flare. Re-flare while addressing the aforementioned problem areas.

Problem/Probable Causes	Remedy
Tube nut continues to back off or loosen	Excessive vibration can cause the 37° tube flare nut to back off from the fitting body. Consider better tube line routing and clamping to protect the fitting/tubing union or control the system vibration. An elastomeric sealing type of tube fitting may be considered as well such as Seal-Lok or EO-2.
Flare on tube fitting is collapsed	37° fittings are susceptible to over-torque. Once the tube fitting has been overtorqued the sealing capability is nearly gone. Additional tightening on the tube/hose joint will only cause additional leakage. Replace fitting and retighten with appropriate torque or FFFT method.
Damaged Fitting	Due to repeated use, abuse, handling, etc., the 37° flare fittings are susceptible to damage on the flare end of the fitting. If flare end is damaged, replace fitting with undamaged fitting. These problems can often be avoided by proper handling and storage, including keeping plastic fitting caps and plugs on until fitting is used.
Tubing is overflared or underflared	If tube is overflared the tube nut will not be able to engage fitting body or not be able to swivel freely. If tubing is underflared, the possibility for tube blow-off is greatly increased and the sealing area is greatly reduced. Re-flare to appropriate flare O.D. specifications as outlined in this catalog.
Pock marks on flare I.D.	Tube end not deburred or cleaned properly before flaring.

Table C5 — Trouble Shooting

Features, Advantages & Benefits

- 1. Single Seal Point** — Triple-Lok fittings have only one seal (between the fitting nose and flare I.D.). This makes a highly reliable joint that is easily maintained.
- 2. Small Seal Area** — Small seal area under pressure makes for high pressure capability at relatively low torque levels. This allows the use of small wrenches for easy installation and maintenance.
- 3. Metal to Metal Seal** — Allows wide operating temperature range for many applications.
- 4. No Minimum Tube Wall Limitation** — Triple-Lok fittings are suitable for very thin to medium wall tubing. This allows use of optimum wall thickness tubing, reducing overall system cost.
- 5. Short Tube Entry** — Minimum tube prying is necessary when maintenance is required on the system. It is easy and quick.
- 6. Adaptability to Metric Tubing** — Triple-Lok fitting sleeves make flared fittings suitable for metric tubing by merely changing the sleeve.
- 7. Adaptability to Hose Assembly** — Triple-Lok fittings allow for direct connection to 37° flare hose assemblies, the most popular industrial hose connection worldwide.
- 8. Forged Shapes** — Triple-Lok fittings have no braze joints to leak. Forgings provide higher dependability and longer life compared to multiple component brazed constructions.
- 9. Hard Forgings** — High hardness of Triple-Lok fittings forged shapes minimizes the deformation of the 37° nose during assembly, maintaining full flow area and good re-useability.
- 10. Cold Formed Sleeves and Nuts** — Sleeves and nuts in popular sizes are cold formed for high strength and toughness through optimum grain flow. This imparts high dependability and long service life.
- 11. International Standard Design** — Triple-Lok fittings offer worldwide availability and interchangeability, they conform to SAE and ISO standards. 37° fittings are the most widely used fitting type in the world.
- 12. Availability** — Triple-Lok fittings are available in the broadest range of sizes and configurations of any fitting. This provides users with the optimum choice of plumbing options. Standard materials offered are steel, stainless steel and brass.

C

Recommended Working Pressure, PSIG

These recommended working pressures represent the capability of the subject fitting. Nevertheless, in some instances, the wall thickness or type of tubing, hose, or hose connector, assembled to the fitting may lower the maximum pressure to which the assembly should be exposed. It is strongly suggested that these fitting working pressure charts be used in conjunction with appropriate pressure charts for tubing or hose during the fitting selection process.

Refer to the definition of pressure rated static and pressure rated dynamic. [Contact Parker](#) for working pressures for all other materials not shown. The following values are based on

a minimum design factor of 4:1 for dynamic and 3:1 for static applications.

Pressure, Rated Static – The maximum pressure that a pressure containing envelope is capable of sustaining in an application not exceeding 30,000 operating cycles in a system free of pressure surges, shocks, vibration, and temperature excursions.





Pressure, Rated Dynamic – The maximum fluctuating pressure load that a pressure containing envelope is capable of sustaining for a minimum of one million operation cycles without failure.







	STATIC			DYNAMIC		
SIZE	STEEL	SS	BRASS	STEEL	SS	BRASS
2	8000	10000	5200	5000	7700	3250
3	8000	10000	5200	5000	7700	3250
4	8000	10000	5200	5000	7700	3250
5	8000	8000	5200	5000	6000	3250
6	6000	8000	3900	4500	6000	2925
8	5000	8000	3250	4000	6000	2600
10	5000	6400	3250	4000	5000	2600
12	4000	6400	2600	3500	5000	2275
12-24	2500	4000	1625	2000	2000	1300
14	3000	4500	1950	2500	2500	1625
16	3000	4500	1950	2500	2500	1625
16-12	3000	4500	1950	2500	2500	1625
20	3000	4000	1950	2500	2500	1625
24	2500	4000	1625	2000	2000	1300
32	2000	2000	1300	1500	1500	975

	STATIC			DYNAMIC		
SIZE	STEEL	SS	BRASS	STEEL	SS	BRASS
2	8000	9600	5200	5000	6000	3250
3	8000	9600	5200	5000	6000	3250
4	8000	9600	5200	5000	6000	3250
4-4	8000	9600	5200	5000	6000	3250
5	8000	9600	5200	5000	6000	3250
5-4	8000	9600	5200	5000	6000	3250
6	6000	8000	3900	4500	6000	2925
6-6	6000	8000	3900	4500	6000	2925
6-8	5000	8000	3250	4000	6000	2600
8	5000	8000	3250	4000	6000	2600
8-8	5000	8000	3250	4000	6000	2600
10	5000	6400	3250	4000	4800	2600
10-6	5000	6400	3250	4000	4800	2600
12	4000	6400	2600	3500	4200	2275
12-8	4000	6400	2600	3500	4200	2275
14	3000	4500	1950	2500	3000	1625
16	3000	4500	1950	2500	3000	1625
16-12	3000	4500	1950	2500	3000	1625
20	3000	3600	1950	2500	3000	1625
24	2500	3000	1625	2000	2400	1300
32	2000	2400	1300	1500	1800	975

* 4 LHX6 static pressure is 7500 psig; other ratings are as shown in chart.

Recommended Working Pressure, PSIG

						
	C50X	CC50X	R50X	S50X	V50X	
	STATIC			DYNAMIC		
SIZE	STEEL	SS	BRASS	STEEL	SS	BRASS
2	6500	8500	4225	5000	6000	3250
3	6500	8500	4225	5000	6000	3250
4	6500	8500	4225	5000	6000	3250
4-5	6000	7200	3900	5000	5400	3250
4-6	6000	7200	3900	5000	5400	3250
4-8	6000	7200	3900	5000	5400	3250
5	6000	7200	3900	5000	5400	3250
5-4	6000	7200	3900	5000	5400	3250
6	6000	7200	3900	5000	5400	3250
6-4	6000	7200	3900	5000	5400	3250
6-6-8	6000	7200	3900	5000	5400	3250
6-8	6000	7200	3900	5000	5400	3250
6-10	5500	7200	3575	4500	5400	2925
8	6000	7200	3900	5000	5400	3250
8-4	6000	7200	3900	5000	5400	3250
8-6	6000	7200	3900	5000	5400	3250
8-10	5500	7200	3575	4500	5400	2925
8-12	5000	7200	3250	4000	5400	2600
8-16	4000	6000	2600	3000	3000	1950
10	5500	7200	3575	4500	5400	2925
10-6	6000	7200	3900	5000	5400	3250
10-8	6000	7200	3900	5000	5400	3250
10-12	5000	7200	3250	4000	5400	2600
10-16	4000	6000	2600	3000	3000	1950
12	5000	7200	3250	4000	5400	2600
12-8	5000	7200	3250	4000	5400	2600
12-10	5000	7200	3250	4000	5400	2600
12-14	4000	6000	2600	3000	3000	1950
12-16	4000	6000	2600	3000	3000	1950
12-20	3500	5000	2275	2500	2500	1625
14	4000	6000	2600	3000	3000	1950
14-16	4000	6000	2600	3000	3000	1950
16	4000	6000	2600	3000	3000	1950
16-12	4000	6000	2600	3000	3000	1950
16-14	4000	6000	2600	3000	3000	1950
16-20	3500	5000	2275	2500	2500	1625
16-24	2500	3600	1625	2000	2000	1300
20	3500	5000	2275	2500	2500	1625
20-16	3500	5000	2275	2500	2500	1625
20-24	2500	3600	1625	2000	2000	1300
24	2500	3600	1625	2000	2000	1300
24-20	3000	3000	1950	2000	2000	1300
24-32	2000	2000	1300	1500	1500	975
32	2000	2000	1300	1500	1500	975

						
	FNTX	HTX	LHTX			
						
	PNTX	TRTX	XHX7			
	STATIC			DYNAMIC		
SIZE	STEEL	SS	BRASS	STEEL	SS	BRASS
2	10000	12500	6500	5000	7700	3250
3	10000	12500	6500	5000	7700	3250
4	10000	12500	6500	5000	7700	3250
4-2	10000	12500	6500	5000	7700	3250
4-3	10000	12500	6500	5000	7700	3250
5	10000	12500	6500	5000	7700	3250
5-4	10000	12500	6500	5000	7700	3250
6	10000	12500	6500	5000	7700	3250
6-4	10000	12500	6500	5000	7700	3250
6-5	10000	12500	6500	5000	7700	3250
8	8500	12500	5525	5000	7700	3250
8-4	8500	12500	5525	5000	7700	3250
8-6	8500	12500	5525	5000	7700	3250
10	8000	12500	5200	5000	6000	3250
10-4	8000	12500	5200	5000	6000	3250
10-6	8000	12500	5200	5000	6000	3250
10-8	8000	12500	5200	5000	6000	3250
12	7000	12500	4550	5000	6000	3250
12-4	7000	12500	4550	5000	6000	3250
12-6	7000	12500	4550	5000	6000	3250
12-8	7000	12500	4550	5000	6000	3250
12-10	7000	12500	4550	5000	6000	3250
14	6000	7200	3900	4000	4800	2600
14-6	6000	7200	3900	4000	4800	2600
14-10	6000	7200	3900	4000	4800	2600
14-12	6000	7200	3900	4000	4800	2600
16	6000	7200	3900	4000	4800	2600
16-4	6000	7200	3900	4000	4800	2600
16-6	6000	7200	3900	4000	4800	2600
16-12	6000	7200	3900	4000	4800	2600
16-14	6000	7200	3900	4000	4800	2600
20	5000	6000	3250	3000	3600	1950
20-12	5000	6000	3250	3000	3600	1950
20-16	5000	6000	3250	3000	3600	1950
24	3000	3600	1950	2000	2400	1300
24-8	3000	3600	1950	2000	2400	1300
24-10	3000	3600	1950	2000	2400	1300
24-12	3000	3600	1950	2000	2400	1300
24-16	3000	3600	1950	2000	2400	1300
24-20	3000	3600	1950	2000	2400	1300
32	2000	2400	1300	1500	1800	975
32-24	2000	2400	1300	1500	1800	975



Recommended Working Pressure, PSIG

<p style="text-align: center;">T22X WTX</p> <p style="text-align: center;">XHLO XHL6 XHBU</p>						
	STATIC			DYNAMIC		
SIZE	STEEL	SS	BRASS	STEEL	SS	BRASS
2	10000	12000	6500	5000	7700	3250
3	10000	12000	6500	5000	7700	3250
4	10000	12000	6500	5000	7700	3250
5	10000	12000	6500	5000	7700	3250
6	10000	12000	6500	5000	7700	3250
6-4	10000	12000	6500	5000	7700	3250
8	8500	12000	5525	5000	7700	3250
8-4	8500	12000	5525	5000	7700	3250
8-6	8500	12000	5525	5000	7700	3250
10	8000	11000	5200	5000	6000	3250
10-4	8000	11000	5200	5000	6000	3250
10-6	8000	11000	5200	5000	6000	3250
10-8	8000	11000	5200	5000	6000	3250
12	7000	11000	4550	5000	6000	3250
12-4	7000	11000	4550	5000	6000	3250
12-6	7000	11000	4550	5000	6000	3250
12-8	7000	11000	4550	5000	6000	3250
12-10	7000	11000	4550	5000	6000	3250
14	6000	7200	3900	4000	4800	2600
14-6	6000	7200	3900	4000	4800	2600
14-10	6000	7200	3900	4000	4800	2600
14-12	6000	7200	3900	4000	4800	2600
16	6000	7200	3900	4000	4800	2600
16-12	6000	7200	3900	4000	4800	2600
16-14	6000	7200	3900	4000	4800	2600
20	5000	6000	3250	3000	3600	1950
20-12	5000	6000	3250	3000	3600	1950
20-16	5000	6000	3250	3000	3600	1950
24	3000	3600	1950	2000	2400	1300
24-20	3000	3600	1950	2000	2400	1300
32	2000	2400	1300	1500	1800	975

<p style="text-align: center;">ETX JTX KTX WETX</p>						
	STATIC			DYNAMIC		
SIZE	STEEL	SS	BRASS	STEEL	SS	BRASS
2	10000	10000	6500	5000	7700	3250
3	10000	10000	6500	5000	7700	3250
4	10000	10000	6500	5000	7700	3250
4-4-3	10000	10000	6500	5000	7700	3250
4-5	10000	10000	6500	5000	6000	3250
4-6	10000	10000	6500	5000	6000	3250
4-8	8000	8000	5200	5000	6000	3250
5	10000	10000	6500	5000	6000	3250
6	10000	10000	6500	5000	6000	3250
6-4	10000	10000	6500	5000	6000	3250
6-8	8000	8000	5200	5000	6000	3250
6-10	7000	7000	4550	5000	5000	3250
8	8000	8000	5200	5000	6000	3250
8-6	8000	8000	5200	5000	6000	3250
8-10	7000	7000	4550	5000	5000	3250
8-12	5000	5000	3250	4500	5000	2925
10	7000	7000	4550	5000	5000	3250
10-8	7000	7000	4550	5000	5000	3250
10-12	5000	5000	3250	4500	5000	2925
12	5000	5000	3250	4500	5000	2925
12-8	5000	5000	3250	4500	5000	2925
12-10	5000	5000	3250	4500	5000	2925
12-12-8	5000	5000	3250	4500	5000	2925
12-16	4500	4500	2925	3500	5000	2275
12-16-12	4500	4500	2925	3500	5000	2275
14	4500	4500	2925	3500	3500	2275
14-16	4500	4500	2925	3500	3500	2275
16	4500	4500	2925	3500	3500	2275
16-12	4500	4500	2925	3500	3500	2275
16-14	4500	4500	2925	3500	3500	2275
16-20	4000	4000	2600	3000	3000	1950
20	4000	4000	2600	3000	3000	1950
20-16	4000	4000	2600	3000	3000	1950
20-24	3000	4000	1950	2000	2000	1300
24	3000	4000	1950	2000	2000	1300
24	3000	4000	1950	2000	2000	1300
24-32	2000	4000	1300	1500	1500	975
32	2000	4000	1300	1500	1500	975

<p style="text-align: center;">XHQ1 XHQ2</p>						
	STATIC			DYNAMIC		
SIZE	STEEL	SS	BRASS	STEEL	SS	BRASS
12	6600	7920	4290	5000	6000	3250
16	6600	7920	4290	5000	6000	3250
20	5300	6360	3445	4000	4800	2600
24	4000	4800	2600	3000	3600	1950
32	4000	4800	2600	3000	3600	1950

<p style="text-align: center;">XEQ1 XEQ2 XVQ1 XVQ2</p>						
	STATIC			DYNAMIC		
SIZE	STEEL	SS	BRASS	STEEL	SS	BRASS
12	6600	6600	4290	5000	5000	3250
16	6600	6600	4290	5000	5000	3250
20	5300	5300	3445	4000	4000	2600
24	4000	4000	2600	3000	3000	1950
32	4000	4000	2600	3000	3000	1950

Recommended Working Pressure, PSIG

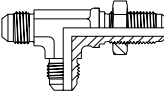
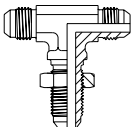
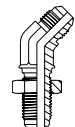
								
		WJTX			WJTX		WNTX	
		STATIC			DYNAMIC			
SIZE	STEEL	SS	BRASS	STEEL	SS	BRASS		
2	10000	10000	6500	5000	7700	3250		
3	10000	10000	6500	5000	7700	3250		
4	10000	10000	6500	5000	7700	3250		
4-5	10000	10000	6500	5000	6000	3250		
4-6	10000	10000	6500	5000	6000	3250		
4-8	8000	8000	5200	5000	6000	3250		
5	10000	10000	6500	5000	6000	3250		
6	10000	10000	6500	5000	6000	3250		
6-8	8000	8000	5200	5000	6000	3250		
6-10	7000	7000	4550	5000	5000	3250		
8	8000	8000	5200	5000	6000	3250		
8-6	8000	8000	5200	5000	6000	3250		
8-10	7000	7000	4550	5000	5000	3250		
8-12	5000	5000	3250	4500	5000	2925		
10	7000	7000	4550	5000	5000	3250		
10-8	7000	7000	4550	5000	5000	3250		
10-12	5000	5000	3250	4500	5000	2925		
12	5000	5000	3250	4500	5000	2925		
12-8	5000	5000	3250	4500	5000	2925		
12-10	5000	5000	3250	4500	5000	2925		
12-16	4500	4500	2925	3500	5000	2275		
14	4500	4500	2925	3500	3500	2275		
14-16	4500	4500	2925	3500	3500	2275		
16	4500	4500	2925	3500	3500	2275		
16-12	4500	4500	2925	3500	3500	2275		
16-14	4500	4500	2925	3500	3500	2275		
16-20	4000	4000	2600	3000	3000	1950		
20	4000	4000	2600	3000	3000	1950		
20-16	4000	4000	2600	3000	3000	1950		
20-24	3000	4000	1950	2000	2000	1300		
24	3000	4000	1950	2000	2000	1300		
24-32	2000	4000	1300	1500	1500	975		
32	2000	4000	1300	1500	1500	975		

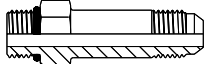
							
		F50X			FF50X		
		STATIC			DYNAMIC		
SIZE	STEEL	SS	BRASS	STEEL	SS	BRASS	
2	8000	12500	5200	5000	7700	3250	
3	8000	12500	5200	5000	7700	3250	
3-2	8000	12500	5200	5000	7700	3250	
4	8000	12500	5200	5000	7700	3250	
4-3	8000	12500	5200	5000	7700	3250	
4-5	8000	12500	5200	5000	7700	3250	
4-6	8000	12500	5200	5000	7700	3250	
4-8	8000	12500	5200	5000	7700	3250	
4-10	7000	12500	4550	5000	6000	3250	
5	8000	12500	5200	5000	7700	3250	
5-4	8000	12500	5200	5000	7700	3250	
5-8	8000	12500	5200	5000	7700	3250	
6	8000	12500	5200	5000	7700	3250	
6-8	8000	12500	5200	5000	7700	3250	
6-10	7500	12500	4875	5000	6000	3250	
6-12	7000	12500	4550	5000	6000	3250	
8	8000	12500	5200	5000	7700	3250	
8-4	8000	12500	5200	5000	7700	3250	
8-6	8000	12500	5200	5000	7700	3250	
8-10	7500	12500	4875	5000	6000	3250	
8-12	7000	12500	4550	5000	6000	3250	
8-16	5500	6600	3575	4500	5400	2925	
10	7500	12500	4875	5000	6000	3250	
10-6	8000	12500	5200	5000	6000	3250	
10-8	8000	12500	5200	5000	6000	3250	
10-12	7000	12500	4550	5000	6000	3250	
10-16	5500	12500	3575	4500	5400	2925	
12	7000	12500	4550	5000	6000	3250	
12-8	7000	12500	4550	5000	6000	3250	
12-10	7000	12500	4550	5000	6000	3250	
12-14	5500	6600	3575	4500	5400	2925	
12-16	5500	6600	3575	4500	5400	2925	
12-20	4000	6000	2600	3000	3600	1950	
14	5500	6600	3575	4500	5400	2925	
14-16	5500	6600	3575	4500	5400	2925	
16	5500	6600	3575	4500	5400	2925	
16-8	5500	6600	3575	4500	5400	2925	
16-12	5500	6600	3575	4500	5400	2925	
16-14	5500	6600	3575	4500	5400	2925	
16-20	4000	6000	2600	3000	3600	1950	
20	4000	6000	2600	3000	3600	1950	
20-12	4000	6000	2600	3000	3600	1950	
20-16	4000	6000	2600	3000	3600	1950	
20-24	3000	6000	1950	2000	2400	1300	
24	3000	6000	1950	2000	2400	1300	
24-32	2000	2400	1300	1500	1800	975	
32	2000	2400	1300	1500	1800	975	
32-24	2000	2400	1300	1500	1800	975	
40	1500	1500	900	1000	1000	600	

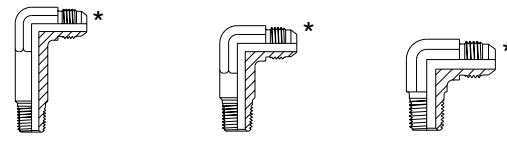

Recommended Working Pressure, PSIG

						
	STATIC			DYNAMIC		
SIZE	STEEL	SS	BRASS	STEEL	SS	BRASS
2	10000	10000	6500	5000	5000	3250
3	10000	10000	6500	5000	5000	3250
4	10000	10000	6500	5000	5000	3250
4-4	10000	10000	6500	5000	5000	3250
4-6	10000	10000	6500	5000	5000	3250
4-8	10000	10000	6500	5000	5000	3250
5	10000	10000	6500	5000	5000	3250
5-4	10000	10000	6500	5000	5000	3250
5-6	10000	10000	6500	5000	5000	3250
6	10000	10000	6500	5000	5000	3250
6-2	10000	10000	6500	5000	5000	3250
6-6	10000	10000	6500	5000	5000	3250
6-8	8500	8500	5525	5000	5000	3250
6-12	5000	5000	3250	4000	4000	2600
8	8000	8000	5200	5000	5000	3250
8-4	8000	8000	5200	5000	5000	3250
8-8	8000	8000	5200	5000	5000	3250
8-12	5000	5000	3250	4000	4000	2600
8-16	4000	4000	2600	3000	3000	1950
10	7000	7000	4550	5000	5000	3250
10-6	7000	7000	4550	5000	5000	3250
10-12	5500	5500	3575	4000	4000	2600
10-16	4000	4000	2600	3000	3000	1950
12	5000	5000	3250	4000	4000	2600
12-6	5000	5000	3250	4000	4000	2600
12-8	5000	5000	3250	4500	4500	2925
12-16	4000	4000	2600	3000	3000	1950
14	4500	4500	2925	3500	3500	2275
16	4000	4000	2600	3000	3000	1950
16-8	4000	4000	2600	3000	3000	1950
16-12	4500	4500	2925	3500	3500	2275
16-20	3000	3000	1950	2500	2500	1625
20	3000	3000	1950	2500	2500	1625
20-16	4000	4000	2600	3000	3000	1950
20-24	3000	3000	1950	2000	2000	1300
24	3000	3000	1950	2000	2000	1300
24-20	3000	3000	1950	2000	2000	1300
24-32	2000	2000	1300	1500	1500	975
32	2000	2000	1300	1500	1500	975
32-24	2000	2000	1300	1500	1500	975

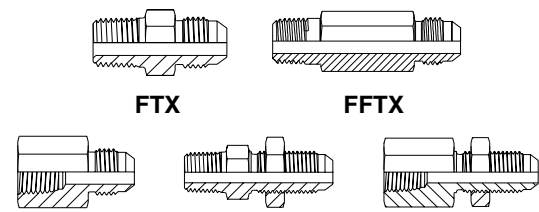
						
	STATIC			DYNAMIC		
SIZE	STEEL	SS	BRASS	STEEL	SS	BRASS
2	10000	12000	6500	5000	6000	3250
3	10000	12000	6500	5000	6000	3250
4	10000	12000	6500	5000	6000	3250
4-4	10000	12000	6500	5000	6000	3250
4-4-6	10000	12000	6500	5000	6000	3250
4-6	10000	12000	6500	5000	6000	3250
4-8	10000	12000	6500	5000	6000	3250
5	10000	12000	6500	5000	6000	3250
5-4	10000	12000	6500	5000	6000	3250
5-4-5	10000	12000	6500	5000	6000	3250
6	10000	12000	6500	5000	6000	3250
6-2	10000	12000	6500	5000	6000	3250
6-6	10000	12000	6500	5000	6000	3250
6-8	8500	10200	5525	5000	6000	3250
8	8000	9600	5200	5000	6000	3250
8-4	8000	9600	5200	5000	6000	3250
8-8	8000	9600	5200	5000	6000	3250
8-12	5000	6000	3250	4000	4800	2600
10	7000	8400	4550	5000	6000	3250
10-6	7000	8400	4550	5000	6000	3250
10-12	5500	6600	3575	4000	4800	2600
12	5000	6000	3250	4000	4800	2600
12-8	5000	6000	3250	4500	5400	2925
12-8-12	5000	6000	3250	4500	5400	2925
12-16	4000	4800	2600	3000	3600	1950
12-20	3000	3600	1950	2500	3000	1625
14	4500	5400	2925	3500	4200	2275
16	4000	5000	2600	3000	3600	1950
16-12	4500	5000	2925	3500	4200	2275
16-20	3000	5000	1950	2500	3000	1625
20	3000	5000	1950	2500	3000	1625
20-16	4000	5000	2600	3000	3600	1950
20-24	3000	5000	1950	2000	2400	1300
24	3000	5000	1950	2000	2400	1300
24-20	3000	5000	1950	2000	2400	1300
24-32	2000	2400	1300	1500	1800	975
32	2000	2400	1300	1500	1800	975
40	1500	1500	900	1000	1000	600

* Shaped connectors (elbows, tees and crosses) with pipe threads have low reliability for leak free operation in dynamic systems. For total leak free reliability in such systems, connectors with O-ring sealing such as SAE straight thread or SAE four bolt split flange are recommended.

Recommended Working Pressure, PSIG

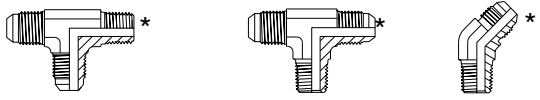
						
	STATIC			DYNAMIC		
SIZE	STEEL	SS	BRASS	STEEL	SS	BRASS
2	10000	10000	6500	5000	5000	3250
3	10000	10000	6500	5000	5000	3250
4	10000	10000	6500	5000	5000	3250
4-4	10000	10000	6500	5000	5000	3250
4-6	10000	10000	6500	5000	5000	3250
4-8	10000	10000	6500	5000	5000	3250
5	10000	10000	6500	5000	5000	3250
5-4	10000	10000	6500	5000	5000	3250
5-6	10000	10000	6500	5000	5000	3250
6	10000	10000	6500	5000	5000	3250
6-2	10000	10000	6500	5000	5000	3250
6-6	10000	10000	6500	5000	5000	3250
6-8	8500	8500	5525	5000	5000	3250
6-12	5000	5000	3250	4000	4000	2600
8	8000	8000	5200	5000	5000	3250
8-2	8000	8000	5200	5000	5000	3250
8-4	8000	8000	5200	5000	5000	3250
8-8	8000	8000	5200	5000	5000	3250
8-12	5000	5000	3250	4000	4000	2600
8-16	4000	4000	2600	3000	3000	1950
10	7000	7000	4550	5000	5000	3250
10-6	7000	7000	4550	5000	5000	3250
10-12	5500	5500	3575	4000	4000	2600
12	5000	5000	3250	4000	4000	2600
12-6	5000	5000	3250	4000	4000	2600
12-8	5000	5000	3250	4500	4500	2925
12-16	4000	4000	2600	3000	3000	1950
14	4500	4500	2925	3500	3500	2275
16	4000	4000	2600	3000	3000	1950
16-8	4000	4000	2600	3000	3000	1950
16-12	4500	4500	2925	3500	3500	2275
16-20	3000	3000	1950	2500	2500	1625
16-24	3000	3000	1950	2000	2000	1300
20	3000	3000	1950	2500	2500	1625
20-16	4000	4000	2600	3000	3000	1950
24	3000	3000	1950	2000	2000	1300
24-16	3000	3000	1950	2000	2000	1300
24-20	3000	3000	1950	2000	2000	1300
32	2000	2000	1300	1500	1500	975
32-24	2000	2000	1300	1500	1500	975

* Shaped connectors (elbows, tees and crosses) with pipe threads have low reliability for leak free operation in dynamic systems. For total leak free reliability in such systems, connectors with O-ring sealings such as SAE straight thread or SAE four bolt split flange are recommended.

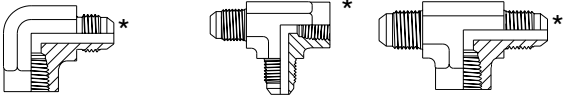
						
	STATIC			DYNAMIC		
SIZE	STEEL	SS	BRASS	STEEL	SS	BRASS
2	7000	7000	4550	5000	5000	3250
3	7000	7000	4550	5000	5000	3250
4	7000	7000	4550	5000	5000	3250
4-4	7000	7000	4550	5000	5000	3250
4-8	4000	4000	2600	3000	3000	1950
5	7000	7000	4550	5000	5000	3250
5-4	7000	7000	4550	5000	5000	3250
6	7000	7000	4550	5000	5000	3250
6-2	7000	7000	4550	5000	5000	3250
6-6	6000	6000	3900	4500	4500	2925
6-6-6	6000	6000	3900	4500	4500	2925
6-8	4000	4000	2600	3000	3000	1950
8	6000	6000	3900	3000	3000	1950
8-4	7000	7000	4550	5000	5000	3250
8-8	4000	4000	2600	3000	3000	1950
8-8-8	4000	4000	2600	3000	3000	1950
8-12	4000	4000	2600	3000	3000	1950
10	4000	4000	2600	3000	3000	1950
10-6	6000	6000	3900	5000	5000	3250
10-12	4000	4000	2600	3000	3000	1950
12	4000	4000	2600	3000	3000	1950
12-8	4000	4000	2600	3000	3000	1950
12-10	4000	4000	2600	3000	3000	1950
12-16	2250	2250	1463	1750	1750	1138
14	4000	4000	2600	3000	3000	1950
16	2250	2250	1463	1750	1750	1138
16-12	4000	4000	2600	3000	3000	1950
20	2000	2000	1300	1500	1500	975
20-16	2250	2250	1463	1750	1750	1138
24	2000	2000	1300	1500	1500	975
24-20	2000	2000	1300	1500	1500	975
32	1250	1250	813	1000	1000	650

* Shaped connectors (elbows, tees and crosses) with pipe threads have low reliability for leak free operation in dynamic systems. For total leak free reliability in such systems, connectors with O-ring sealings such as SAE straight thread or SAE four bolt split flange are recommended.



How to Order Information

How To Order Triple-Lok Tube Fittings

Nomenclature

Triple-Lok fitting part numbers are constructed from symbols that identify the size and style of the fitting and material used.

Sizes

2 through 32. (Tube sizes are determined by the number of sixteenths of an inch in the tube O.D.)

Materials

Type 316 Stainless Steel, Steel and Brass. Triple-Lok tube fittings for special applications can be furnished in almost any material suitable for machining.

Example

Fitting needed — Triple-Lok Steel Male Connector for 1/4" O.D. Tube and 1/4" Male Pipe Thread. Part number 4-4 FBTX-S

4-4	F*	B	TX	-	S	BP
1/4" Tube O.D. (4/16")	Male Connector	Assembled Fitting	Parker Triple-lok		Material Steel	Bulk-Pack (Where avail)
1/4" Male Pipe Thread						

* The Number "5" after the letter "F" is used to designate Straight Thread, and the number "6" is used to designate Swivel Nut.

Crosses and Tees

For tees — first size the run (1 to 2) and then the branch (3).

For crosses — first size the run (1 to 2) and then the branch (3 to 4).

Special Fittings

If design or configuration is questionable please provide a detailed sketch, drawing or sample part to the Division.

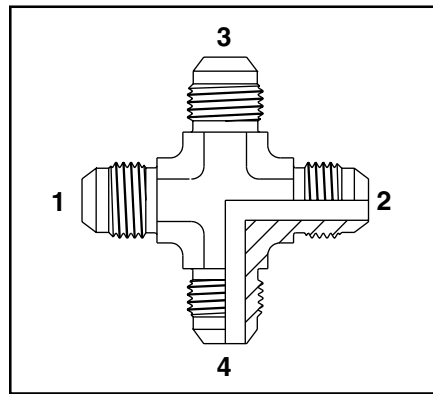

Long Straight Thread Elbow CC50X

Flare tube end / straight thread O-ring

SAE 071520

Part Number Information

CC5X - Body only

CC5BX - Body with tube nut, sleeve and O-ring

CC50X - Body with O-ring

All dimensions are in inches

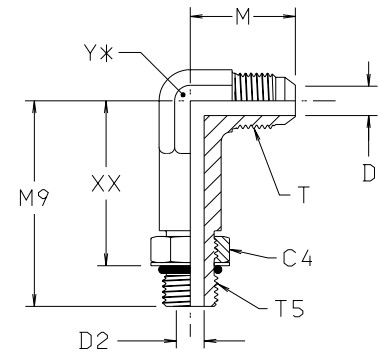

*Y—ACROSS WRENCH FLATS

TUBE FITTING PART #	HOSE FITTING PART #	TUBE O.D. (inch)	T TUBE END UN/UNF-2A	T5 PORT THD UN/UNF-2A	C4 HEX (inch)	D DRILL (inch)	D2 DRILL (inch)	M (inch)	M9 (inch)	XX AFTER ASSY (inch)	Y (inch)	STANDARD MATERIAL FROM STOCK		
												S	SS	B
4 CC50X	5503-4-4	1/4	7/16-20	7/16-20	9/16	0.172	0.172	1.00	1.73	1.34	9/16	•		
6 CC50X	5503-6-6	3/8	9/16-18	9/16-18	11/16	0.297	0.297	1.06	2.08	1.65	9/16	•		
8 CC50X	5503-8-8	1/2	3/4-16	3/4-16	7/8	0.391	0.391	1.25	2.50	2.01	7/8	•		
10 CC50X	5503-10-10	5/8	7/8-14	7/8-14	1	0.484	0.484	1.45	2.89	2.33	7/8	•		
12 CC50X	5503-12-12	3/4	1 1/16-12	1 1/16-12	1 1/4	0.609	0.609	1.66	3.34	2.69	1 1/16	•		
16 CC50X	5503-16-16	1	1 5/16-12	1 5/16-12	1 1/2	0.844	0.844	1.81	3.72	3.07	1 5/16	•		

Long Straight Thread Connector FF50X

Flare tube end / straight thread O-ring

SAE 071720 MS515XX* (Formerly SAE 070122)

Part Number Information

FF5X - Body only

FF5BX - Body with tube nut, sleeve and O-ring

FF50X - Body with O-ring

All dimensions are in inches

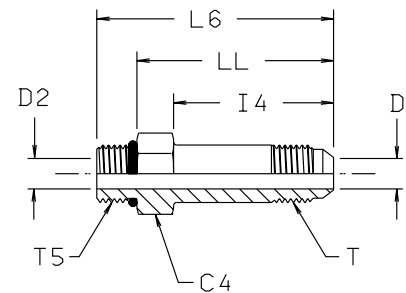

TUBE FITTING PART #	HOSE FITTING PART #	TUBE O.D. (inch)	T TUBE END UN/UNF-2A	T5 PORT THD UN/UNF-2A	C4 HEX (inch)	D DRILL (inch)	D2 DRILL (inch)	I4 (inch)	L6 (inch)	LL AFTER ASSY (inch)	STANDARD MATERIAL FROM STOCK		
											S	SS	B
4 FF50X	5E03-4-4	1/4	7/16-20	7/16-20	9/16	0.172	0.172	1.39	2.08	1.72	•	•	
6 FF50X	5E03-6-6	3/8	9/16-18	9/16-18	11/16	0.297	0.297	1.56	2.31	1.92	•	•	
8 FF50X	5E03-8-8	1/2	3/4-16	3/4-16	7/8	0.391	0.391	1.88	2.70	2.26	•	•	
10 FF50X	5E03-10-10	5/8	7/8-14	7/8-14	1	0.484	0.484	2.09	3.03	2.53	•	•	
12 FF50X	5E03-12-12	3/4	1 1/16-12	1 1/16-12	1 1/4	0.609	0.609	2.50	3.61	3.02	•	•	
16 FF50X	5E03-16-16	1	1 5/16-12	1 5/16-12	1 1/2	0.844	0.844	2.84	3.98	3.39	•	•	
20 FF50X	5E03-20-20	1 1/4	1 5/8-12	1 5/8-12	1 7/8	1.078	1.078	3.47	4.69	4.10	•	•	

*Please see page C6 for conformance to military specifications.

Straight Thread Elbow C5OX

Flare tube end / straight thread O-ring

SAE 070220 MS515XX*

Part Number Information

C5X - Body only

C5BX - Body with tube nut, sleeve and O-ring

C5OX - Body with O-ring

All dimensions are in inches

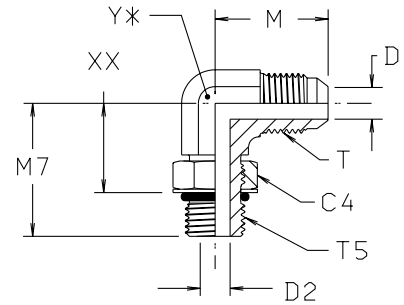

*Y—ACROSS WRENCH FLATS

TUBE FITTING PART #	HOSE FITTING PART #	TUBE O.D. (inch)	T TUBE END UN/UNF-2A	T5 PORT THD UN/UNF-2A	C4 HEX (inch)	D DRILL (inch)	D2 DRILL (inch)	M (inch)	M7 (inch)	XX AFTER ASSY (inch)	Y (inch)	STANDARD MATERIAL FROM STOCK		
												S	SS	B
2 C5OX	2503-2-2	1/8	5/16-24	5/16-24	7/16	0.062	0.062	0.78	0.94	0.58	7/16	•	•	
3 C5OX	2503-3-3	3/16	3/8-24	3/8-24	1/2	0.125	0.125	0.83	0.94	0.61	7/16	•	•	
4 C5OX	2503-4-4	1/4	7/16-20	7/16-20	9/16	0.172	0.172	0.89	1.03	0.64	7/16	•	•	
4-6 C5OX	2503-6-4	1/4	7/16-20	9/16-18	11/16	0.172	0.297	1.05	1.25	0.82	9/16	•	•	
5 C5OX	2503-5-5	5/16	1/2-20	1/2-20	5/8	0.234	0.234	0.95	1.13	0.70	9/16	•	•	
5-4 C5OX	2503-4-5	5/16	1/2-20	7/16-18	9/16	0.234	0.172	0.95	1.13	0.74	9/16	•	•	
5-6 C5OX	2503-6-5	5/16	1/2-20	9/16-18	11/16	0.234	0.297	0.94	1.25	0.79	9/16	•	•	
6 C5OX	2503-6-6	3/8	9/16-18	9/16-18	11/16	0.297	0.297	1.06	1.25	0.82	9/16	•	•	
6-4 C5OX	2503-4-6	3/8	9/16-18	7/16-20	9/16	0.297	0.172	1.06	1.19	0.80	9/16	•	•	
6-5 C5OX	2503-5-6	3/8	9/16-18	1/2-20	5/8	0.297	0.234	1.06	1.19	0.72	9/16	•	•	
6-8 C5OX	2503-8-6	3/8	9/16-18	3/4-16	7/8	0.297	0.391	1.14	1.45	0.96	3/4	•	•	
6-10 C5OX	2503-10-6	3/8	9/16-18	7/8-14	1	0.297	0.484	1.23	1.70	1.24	7/8	•	•	
8 C5OX	2503-8-8	1/2	3/4-16	3/4-16	7/8	0.391	0.391	1.25	1.45	0.96	3/4	•	•	
8-4 C5OX	2503-4-8	1/2	3/4-16	7/16-20	9/16	0.391	0.172	1.25	1.27	0.88	3/4	•	•	
8-6 C5OX	2503-6-8	1/2	3/4-16	9/16-18	11/16	0.391	0.297	1.25	1.36	0.89	3/4	•	•	
8-10 C5OX	2503-10-8	1/2	3/4-16	7/8-14	1	0.391	0.484	1.34	1.70	1.14	7/8	•	•	
8-12 C5OX	2503-12-8	1/2	3/4-16	1 1/16-12	1 1/4	0.391	0.609	1.42	1.94	1.47	1 1/16	•	•	
8-16 C5OX	2503-16-8	1/2	3/4-16	1 5/16-12	1 1/2	0.391	0.844	1.54	2.05	1.40	1 5/16	•	•	
10 C5OX	2503-10-10	5/8	7/8-14	7/8-14	1	0.484	0.484	1.45	1.70	1.14	7/8	•	•	
10-6 C5OX	2503-6-10	5/8	7/8-14	9/16-18	11/16	0.484	0.297	1.45	1.41	0.98	7/8	•	•	
10-8 C5OX	2503-8-10	5/8	7/8-14	3/4-16	7/8	0.484	0.391	1.45	1.55	1.06	7/8	•	•	
10-12 C5OX	2503-12-10	5/8	7/8-14	1 1/16-12	1 1/4	0.484	0.609	1.53	1.94	1.29	1 1/16	•	•	
10-16 C5OX	2503-16-10	5/8	7/8-14	1 5/16-12	1 1/2	0.484	0.844	1.64	2.05	1.40	1 5/16	•	•	
12 C5OX	2503-12-12	3/4	1 1/16-12	1 1/16-12	1 1/4	0.609	0.609	1.66	1.94	1.29	1 1/16	•	•	
12-8 C5OX	2503-8-12	3/4	1 1/16-12	3/4-16	7/8	0.609	0.391	1.66	1.63	1.16	1 1/16	•	•	
12-10 C5OX	2503-10-12	3/4	1 1/16-12	7/8-14	1	0.609	0.484	1.66	1.78	1.22	1 1/16	•	•	
12-14 C5OX	2503-14-12	3/4	1 1/16-12	1 3/16-12	1 3/8	0.609	0.718	1.77	2	1.35	1 5/16	•	•	
12-16 C5OX	2503-16-12	3/4	1 1/16-12	1 5/16-12	1 1/2	0.609	0.844	1.81	2.05	1.40	1 5/16	•	•	
12-20 C5OX	2503-20-12	3/4	1 1/16-12	1 5/8-12	1 7/8	0.609	1.078	1.97	2.25	1.60	1 5/8	•	•	
14 C5OX	2503-14-14	7/8	1 3/16-12	1 3/16-12	1 3/8	0.718	0.718	1.73	2.00	1.35	1 5/16	•	•	
16 C5OX	2503-16-16	1	1 5/16-12	1 5/16-12	1 1/2	0.844	0.844	1.81	2.05	1.40	1 5/16	•	•	
16-12 C5OX	2503-12-16	1	1 5/16-12	1 1/16-12	1 1/4	0.844	0.609	1.81	2.05	1.40	1 5/16	•	•	
16-14 C5OX	2503-16-14	1	1 5/16-12	1 3/16-12	1 3/8	0.844	0.718	1.81	2.07	1.42	1 5/16	•	•	
16-20 C5OX	2503-20-16	1	1 5/16-12	1 5/8-12	1 7/8	0.844	1.078	2.01	2.25	1.60	1 5/8	•	•	
16-24 C5OX	2503-24-16	1	1 5/16-12	1 7/8-12	2 1/8	0.844	1.312	2.16	2.39	1.74	1 7/8	•	•	
20 C5OX	2503-20-20	1 1/4	1 5/8-12	1 5/8-12	1 7/8	1.078	1.078	2.06	2.25	1.60	1 5/8	•	•	
20-16 C5OX	2503-16-20	1 1/4	1 5/8-12	1 5/16-12	1 1/2	1.078	0.844	2.06	2.25	1.60	1 5/8	•	•	
20-24 C5OX	2503-24-20	1 1/4	1 5/8-12	1 7/8-12	2 1/8	1.078	1.312	2.20	2.39	1.74	1 7/8	•	•	
24 C5OX	2503-24-24	1 1/2	1 7/8-12	1 7/8-12	2 1/8	1.312	1.312	2.33	2.39	1.74	1 7/8	•	•	
24-20 C5OX	2503-20-24	1 1/2	1 7/8-12	1 5/8-12	1 7/8	1.312	1.078	2.33	2.39	1.74	1 7/8	•	•	
32 C5OX	2503-32-32	2	2 1/2-12	2 1/2-12	2 3/4	1.781	1.781	3.06	2.89	2.30	2 1/2	•	•	

*Please see page C6 for conformance to military specifications.

Straight Thread Connector

F50X

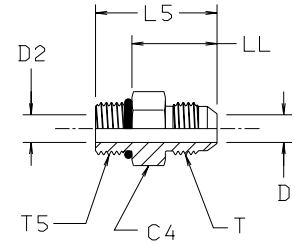

Flare tube end / straight thread O-ring

SAE 070120 MS515XX*

Part Number Information

F5X - Body only

F5BX - Body with tube nut, sleeve and O-ring

F5OX - Body with O-ring

All dimensions are in inches

TUBE FITTING PART #	HOSE FITTING PART #	TUBE O.D. (inch)	T TUBE END UN/UNF-2A	T5 PORT THD UN/UNF-2A	C4 HEX (inch)	D DRILL (inch)	D2 DRILL (inch)	L5 (inch)	LL (inch)	STANDARD MATERIAL FROM STOCK		
										S	SS	B
2 F5OX	0503-2-2	1/8	5/16-24	5/16-24	7/16	0.062	0.062	1.06	0.76	•	•	
3 F5OX	0503-3-3	3/16	3/8-24	3/8-24	1/2	0.125	0.125	1.10	0.80	•	•	
3-2 F5OX	0503-2-3	3/16	3/8-24	5/16-24	1/2	0.125	0.062	1.10	0.80	•	•	
4 F5OX	0503-4-4	1/4	7/16-20	7/16-20	9/16	0.172	0.172	1.23	0.87	•	•	
4-3 F5OX	0503-3-4	1/4	7/16-20	3/8-24	9/16	0.172	0.125	1.19	0.89	•	•	
4-5 F5OX	0503-5-4	1/4	7/16-20	1/2-20	5/8	0.172	0.234	1.23	0.87	•	•	
4-6 F5OX	0503-6-4	1/4	7/16-20	9/16-18	11/16	0.172	0.297	1.28	0.89	•	•	
4-8 F5OX	0503-8-4	1/4	7/16-20	3/4-16	7/8	0.172	0.391	1.38	0.94	•	•	
4-10 F5OX	0503-10-4	1/4	7/16-20	7/8-14	1	0.172	0.172	1.49	0.99	•	•	
5 F5OX	0503-5-5	5/16	1/2-20	1/2-20	5/8	0.234	0.234	1.23	0.87	•	•	
5-4 F5OX	0503-4-5	5/16	1/2-20	7/16-20	9/16	0.234	0.172	1.23	0.87	•	•	
5-6 F5OX	0503-6-5	5/16	1/2-20	9/16-18	11/16	0.234	0.234	1.30	0.91	•	•	
5-8 F5OX	0503-8-5	5/16	1/2-20	3/4-16	7/8	0.234	0.234	1.37	0.93	•	•	
6 F5OX	0503-6-6	3/8	9/16-18	9/16-18	11/16	0.297	0.297	1.30	0.91	•	•	
6-4 F5OX	0503-4-6	3/8	9/16-18	7/16-20	5/8	0.297	0.172	1.27	0.91	•	•	
6-5 F5OX	0503-5-6	3/8	9/16-18	1/2-20	5/8	0.297	0.234	1.27	0.91	•	•	
6-8 F5OX	0503-8-6	3/8	9/16-18	3/4-16	7/8	0.297	0.391	1.38	0.94	•	•	
6-10 F5OX	0503-10-6	3/8	9/16-18	7/8-14	1	0.297	0.484	1.50	1.00	•	•	
6-12 F5OX	0503-12-6	3/8	9/16-18	1 1/16-12	1 1/4	0.297	0.609	1.66	1.07	•	•	
8 F5OX	0503-8-8	1/2	3/4-16	3/4-16	7/8	0.391	0.391	1.48	1.04	•	•	
8-4 F5OX	0503-4-8	1/2	3/4-16	7/16-20	13/16	0.391	0.172	1.50	1.14	•	•	
8-6 F5OX	0503-6-8	1/2	3/4-16	9/16-18	13/16	0.391	0.297	1.44	1.05	•	•	
8-10 F5OX	0503-10-8	1/2	3/4-16	7/8-14	1	0.391	0.484	1.59	1.09	•	•	
8-12 F5OX	0503-12-8	1/2	3/4-16	1 1/16-12	1 1/4	0.391	0.609	1.77	1.18	•	•	
8-16 F5OX	0503-16-8	1/2	3/4-16	1 5/16-12	1 1/2	0.391	0.391	1.78	1.19	•	•	
10 F5OX	0503-10-10	5/8	7/8-14	7/8-14	1	0.484	0.484	1.70	1.20	•	•	
10-6 F5OX	0503-6-10	5/8	7/8-14	9/16-18	11/16	0.484	0.297	1.71	1.32	•	•	
10-8 F5OX	0503-8-10	5/8	7/8-14	3/4-16	15/16	0.484	0.391	1.64	1.17	•	•	
10-12 F5OX	0503-12-10	5/8	7/8-14	1 1/16-12	1 1/4	0.484	0.609	1.86	1.27	•	•	
10-16 F5OX	0503-16-10	5/8	7/8-14	1 5/16-12	1 1/2	0.484	0.484	1.89	1.30	•	•	
12 F5OX	0503-12-12	3/4	1 1/16-12	1 1/16-12	1 1/4	0.609	0.609	1.97	1.38	•	•	
12-8 F5OX	0503-8-12	3/4	1 1/16-12	3/4-16	1 1/8	0.609	0.391	1.94	1.50	•	•	
12-10 F5OX	0503-10-12	3/4	1 1/16-12	7/8-14	1 1/8	0.609	0.484	1.88	1.38	•	•	
12-14 F5OX	0503-14-12	3/4	1 1/16-12	1 3/16-12	1 3/8	0.609	0.609	1.96	1.37	•	•	
12-16 F5OX	0503-16-12	3/4	1 1/16-12	1 5/16-12	1 1/2	0.609	0.609	1.99	1.40	•	•	
12-20 F5OX	0503-20-12	3/4	1 1/16-12	1 5/8-12	1 7/8	0.609	0.609	2.08	1.49	•	•	
14 F5OX	0503-14-14	7/8	1 3/16-12	1 3/16-12	1 3/8	0.718	0.718	1.99	1.40	•	•	
14-16 F5OX	0503-16-14	7/8	1 3/16-12	1 5/16-12	1 1/2	0.718	0.844	2.02	1.43	•	•	
16 F5OX	0503-16-16	1	1 5/16-12	1 5/16-12	1 1/2	0.844	0.844	2.05	1.46	•	•	
16-8 F5OX	0503-8-16	1	1 5/16-12	3/4-16	1 3/8	0.844	0.391	1.78	1.34	•	•	
16-10 F5OX	0503-10-16	1	1 5/16-12	7/8-14	1 3/8	0.844	0.484	2.08	1.57	•	•	
16-12 F5OX	0503-12-16	1	1 5/16-12	1 1/16-12	1 3/8	0.844	0.609	1.99	1.40	•	•	
16-14 F5OX	0503-14-16	1	1 5/16-12	1 3/16-12	1 3/8	0.844	0.718	2.05	1.46	•	•	
16-20 F5OX	0503-20-16	1	1 5/16-12	1 5/8-12	1 7/8	0.844	1.078	2.13	1.54	•	•	
16-24 F5OX	0503-24-16	1	1 5/16-12	1 7/8-12	2 1/8	0.844	0.844	2.20	1.61	•	•	
20 F5OX	0503-20-20	1 1/4	1 5/8-12	1 5/8-12	1 7/8	1.078	1.078	2.17	1.58	•	•	
20-12 F5OX	0503-12-20	1 1/4	1 5/8-12	1 1/16-12	1 11/16	1.078	0.609	2.30	1.71	•	•	
20-16 F5OX	0503-16-20	1 1/4	1 5/8-12	1 5/16-12	1 11/16	1.078	0.844	2.33	1.74	•	•	
20-24 F5OX	0503-24-20	1 1/4	1 5/8-12	1 7/8-12	2 1/8	1.078	1.078	2.24	1.65	•	•	
24 F5OX	0503-24-24	1 1/2	1 7/8-12	1 7/8-12	2 1/8	1.312	1.312	2.38	1.79	•	•	
24-20 F5OX	0503-20-24	1 1/2	1 7/8-12	1 5/8-12	2	1.312	1.078	2.53	1.94	•	•	
24-32 F5OX	0503-32-24	1 1/2	1 7/8-12	2 1/2-12	2 3/4	1.312	1.312	2.53	1.94	•	•	
32 F5OX	0503-32-32	2	2 1/2-12	2 1/2-12	2 3/4	1.781	1.781	2.78	2.19	•	•	
32-24 F5OX	0503-24-32	2	2 1/2-12	1 7/8-12	2 5/8	1.781	1.312	2.94	2.35	•	•	

*Please see page C6 for conformance to military specifications.



Straight Thread Run Tee

R50X

Flare tube ends / straight thread O-ring

SAE 070428 MS515XX*

Part Number Information

R5X - Body only

R5BX - Body with tube nuts, sleeves and O-ring

R50X - Body with O-ring

All dimensions are in inches

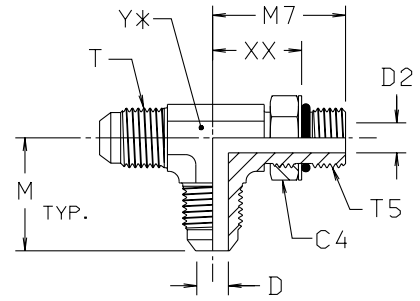

TUBE FITTING PART #	HOSE FITTING PART #	TUBE O.D. (inch)	T TUBE END UN/UNF-2A	T5 PORT THD UN/UNF-2A	C4 HEX (inch)	D DRILL (inch)	D2 DRILL (inch)	M (inch)	M7 (inch)	XX AFTER ASSY (inch)	Y (inch)	STANDARD MATERIAL FROM STOCK		
												S	SS	B
4 R50X	053T-4-4	1/4	7/16-20	7/16-20	9/16	0.172	0.172	0.89	1.03	0.64	7/16	•	•	
5 R50X	053T-5-5	5/16	1/2-20	1/2-20	5/8	0.234	0.234	0.97	1.13	0.70	9/16	•	•	
6 R50X	053T-6-6	3/8	9/16-18	9/16-18	11/16	0.297	0.297	1.06	1.25	0.82	9/16	•	•	
8 R50X	053T-8-8	1/2	3/4-16	3/4-16	7/8	0.391	0.391	1.25	1.45	0.96	3/4	•	•	
10 R50X	053T-10-10	5/8	7/8-14	7/8-14	1	0.484	0.484	1.45	1.70	1.14	7/8	•	•	
12 R50X	053T-12-12	3/4	1 1/16-12	1 1/16-12	1 1/4	0.609	0.609	1.66	1.94	1.29	1 1/16	•	•	
16 R50X	053T-16-16	1	1 5/16-12	1 5/16-12	1 1/2	0.844	0.844	1.81	2.05	1.40	1 5/16	•	•	
20 R50X	053T-20-20	1 1/4	1 5/8-12	1 5/8-12	1 7/8	1.078	1.078	2.06	2.25	1.60	1 5/8	•	•	
24 R50X	053T-24-24	1 1/2	1 7/8-12	1 7/8-12	2 1/8	1.312	1.312	2.33	2.39	1.74	1 7/8	•	•	
32 R50X	053T-32-32	2	2 1/2-12	2 1/2-12	2 3/4	1.781	1.781	3.06	2.89	2.23	2 1/2	•	•	

*Please see page C6 for conformance to military specifications.

Straight Thread Branch Tee

S50X

Flare tube ends / straight thread O-ring

SAE 070429 MS515XX*

Part Number Information

S5X - Body only

S5BX - Body with tube nuts, sleeves and O-ring

S50X - Body with O-ring

All dimensions are in inches

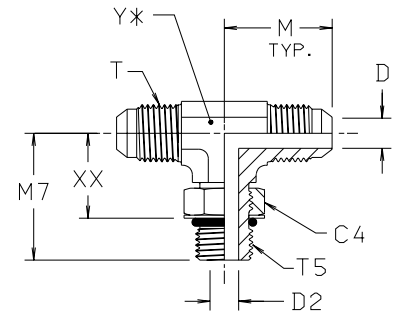

TUBE FITTING PART #	HOSE FITTING PART #	TUBE O.D. (inch)	T TUBE END UN/UNF-2A	T5 PORT THD UN/UNF-2A	C4 HEX (inch)	D DRILL (inch)	D2 DRILL (inch)	M (inch)	M7 (inch)	XX AFTER ASSY (inch)	Y (inch)	STANDARD MATERIAL FROM STOCK		
												S	SS	B
4 S50X	253T-4-4	1/4	7/16-20	7/16-20	9/16	0.172	0.172	0.89	1.03	0.64	7/16	•	•	
5 S50X	253T-5-5	5/16	1/2-20	1/2-20	5/8	0.234	0.234	0.97	1.13	0.70	9/16	•	•	
6 S50X	253T-6-6	3/8	9/16-18	9/16-18	11/16	0.297	0.297	1.06	1.25	0.82	9/16	•	•	
6-6-8 S50X	253T-8-6	3/8	9/16-18	3/4-16	7/8	0.297	0.391	1.14	1.45	0.96	3/4	•	•	
8 S50X	253T-8-8	1/2	3/4-16	3/4-16	7/8	0.391	0.391	1.25	1.45	0.96	3/4	•	•	
10 S50X	253T-10-10	5/8	7/8-14	7/8-14	1	0.484	0.484	1.45	1.70	1.14	7/8	•	•	
12 S50X	253T-12-12	3/4	1 1/16-12	1 1/16-12	1 1/4	0.609	0.609	1.66	1.94	1.29	1 1/16	•	•	
16 S50X	253T-16-16	1	1 5/16-12	1 5/16-12	1 1/2	0.844	0.844	1.81	2.05	1.40	1 5/16	•	•	
20 S50X	253T-20-20	1 1/4	1 5/8-12	1 5/8-12	1 7/8	1.078	1.078	2.06	2.25	1.60	1 5/8	•	•	
24 S50X	253T-24-24	1 1/2	1 7/8-12	1 7/8-12	2 1/8	1.312	1.312	2.33	2.39	1.74	1 7/8	•	•	
32 S50X	253T-32-32	2	2 1/2-12	2 1/2-12	2 3/4	1.781	1.781	3.06	2.89	2.23	2.50	•	•	

*Please see page C6 for conformance to military specifications.

45° Straight Thread Elbow V5OX

Flare tube end / straight thread O-ring

SAE 070320 MS515XX*

Part Number Information

V5X - Body only

V5BX - Body with tube nut, sleeve and O-ring

V5OX - Body with O-ring

All dimensions are in inches

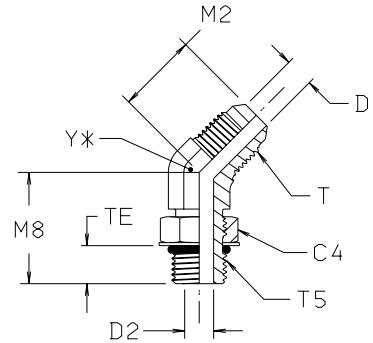

*Y—ACROSS WRENCH FLATS

TUBE FITTING PART #	HOSE FITTING PART #	TUBE O.D. (inch)	T TUBE END UN/UNF-2A	T5 PORT THD UN/UNF-2A	C4 HEX (inch)	D DRILL (inch)	D2 DRILL (inch)	M2 (inch)	M8 (inch)	TE (inch)	Y (inch)	STANDARD MATERIAL FROM STOCK		
												S	SS	B
4 V5OX	3503-4-4	1/4	7/16-20	7/16-20	9/16	0.172	0.172	0.72	1.05	0.39	7/16	•	•	
4-6 V5OX	3503-6-4	1/4	7/16-20	9/16-18	11/16	0.172	0.297	0.82	1.14	0.43	9/16	•	•	
5 V5OX	3503-5-5	5/16	1/2-20	1/2-20	5/8	0.234	0.234	0.77	1.05	0.39	9/16	•		
6 V5OX	3503-6-6	3/8	9/16-18	9/16-18	11/16	0.297	0.297	0.83	1.14	0.43	9/16	•	•	
6-4 V5OX	3503-4-6	3/8	9/16-18	7/16-20	9/16	0.297	0.172	0.83	1.08	0.39	9/16	•		
6-8 V5OX	3503-8-6	3/8	9/16-18	3/4-16	7/8	0.297	0.391	0.86	1.30	0.49	3/4	•		
8 V5OX	3503-8-8	1/2	3/4-16	3/4-16	7/8	0.391	0.391	0.98	1.30	0.49	3/4	•	•	
8-6 V5OX	3503-6-8	1/2	3/4-16	9/16-18	11/16	0.391	0.297	0.98	1.09	0.43	3/4	•	•	
8-10 V5OX	3503-10-8	1/2	3/4-16	7/8-14	1	0.391	0.484	1.00	1.52	0.56	7/8	•	•	
8-12 V5OX	3503-12-8	1/2	3/4-16	1 1/16-12	1 1/4	0.391	0.609	1.06	1.66	0.65	1 1/16	•		
10 V5OX	3503-10-10	5/8	7/8-14	7/8-14	1	0.484	0.484	1.11	1.52	0.56	7/8	•	•	
10-8 V5OX	3503-8-10	5/8	7/8-14	3/4-16	7/8	0.484	0.391	1.11	1.38	0.49	7/8	•		
10-12 V5OX	3503-12-10	5/8	7/8-14	1 1/16-12	1 1/4	0.484	0.609	1.16	1.73	0.65	1 1/16	•		
12 V5OX	3503-12-12	3/4	1 1/16-12	1 1/16-12	1 1/4	0.609	0.609	1.28	1.73	0.65	1 1/16	•	•	
12-10 V5OX	3503-10-12	3/4	1 1/16-12	7/8-14	1	0.609	0.484	1.28	1.58	0.56	1 1/16	•	•	
12-16 V5OX	3503-16-12	3/4	1 1/16-12	1 5/16-12	1 1/2	0.609	0.844	1.42	1.86	0.65	1 5/16	•		
14 V5OX	3503-14-14	7/8	1 3/16-12	1 3/16-12	1 3/8	0.718	0.718	1.45	1.86	0.65	1 5/16	•		
16 V5OX	3503-16-16	1	1 5/16-12	1 5/16-12	1 1/2	0.844	0.844	1.47	1.86	0.65	1 5/16	•	•	
16-12 V5OX	3503-12-16	1	1 5/16-12	1 1/16-12	1 1/2	0.844	0.609	1.47	1.86	0.65	1 5/16	•		
16-20 V5OX	3503-20-16	1	1 5/16-12	1 5/8-12	1 7/8	0.844	1.078	1.55	1.91	0.65	1 5/8	•		
20 V5OX	3503-20-20	1 1/4	1 5/8-12	1 5/8-12	1 7/8	1.078	1.078	1.59	1.91	0.65	1 5/8	•	•	
20-16 V5OX	3503-16-20	1 1/4	1 5/8-12	1 5/16-12	1 1/2	1.078	0.844	1.59	1.91	0.65	1 5/8	•		
24 V5OX	3503-24-24	1 1/2	1 7/8-12	1 7/8-12	2 1/8	1.312	1.312	1.78	1.91	0.65	1 7/8	•		
32 V5OX	3503-32-32	2	2 1/2-12	2 1/2-12	2 3/4	1.781	1.781	2.22	1.86	0.65	2 1/2	•		

*Please see page C6 for conformance to military specifications.

Union Elbow ETX

Flare tube end / flare tube end

SAE 070201 MS515XX*

Part Number Information

ETX - Body only

EBTX - Body with tube nuts and sleeves

All dimensions are in inches

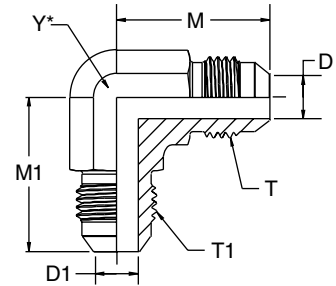

*Y—ACROSS WRENCH FLATS

TUBE FITTING PART #	HOSE FITTING PART #	TUBE O.D. (inch)	T TUBE END UN/UNF-2A	T1 TUBE END UN/UNF-2A	D DRILL (inch)	D1 DRILL (inch)	M (inch)	M1 (inch)	Y (inch)	STANDARD MATERIAL FROM STOCK		
										S	SS	B
2 ETX	2303-2-2	1/8	5/16-24	5/16-24	0.062	0.062	0.78	0.78	7/16	•		
3 ETX	2303-3-3	3/16	3/8-24	3/8-24	0.125	0.125	0.83	0.83	7/16	•	•	
4 ETX	2303-4-4	1/4	7/16-20	7/16-20	0.172	0.172	0.89	0.89	7/16	•	•	•
5 ETX	2303-5-5	5/16	1/2-20	1/2-20	0.234	0.234	0.95	0.95	9/16	•	•	•
6 ETX	2303-6-6	3/8	9/16-18	9/16-18	0.297	0.297	1.06	1.06	9/16	•	•	•
6-4 ETX	2303-4-6	3/8 to 1/4	9/16-18	7/16-20	0.297	0.172	1.06	1.05	9/16	•		
8 ETX	2303-8-8	1/2	3/4-16	3/4-16	0.391	0.391	1.25	1.25	3/4	•	•	•
8-6 ETX	2303-6-8	1/2 to 3/8	3/4-16	9/16-18	0.391	0.297	1.25	1.14	3/4	•		
10 ETX	2303-10-10	5/8	7/8-14	7/8-14	0.484	0.484	1.45	1.45	7/8	•	•	•
10-8 ETX	2303-8-10	5/8 to 1/2	7/8-14	3/4-16	0.484	0.391	1.45	1.33	7/8	•		
12 ETX	2303-12-12	3/4	1 1/16-12	1 1/16-12	0.609	0.609	1.66	1.66	1 1/16	•	•	•
12-8 ETX	2303-8-12	3/4 to 1/2	1 1/16-12	3/4-16	0.609	0.391	1.66	1.42	1 1/16	•		
12-10 ETX	2303-10-12	3/4 to 5/8	1 1/16-12	7/8-14	0.609	0.484	1.66	1.54	1 1/16		•	
14 ETX	2303-14-14	7/8	1 3/16-12	1 3/16-12	0.718	0.718	1.73	1.73	1 3/16	•		
16 ETX	2303-16-16	1	1 5/16-12	1 5/16-12	0.844	0.844	1.81	1.81	1 5/16	•	•	•
16-12 ETX	2303-12-16	1 to 3/4	1 5/16-12	1 1/16-12	0.844	0.609	1.81	1.77	1 5/16			
20 ETX	2303-20-20	1 1/4	1 5/8-12	1 5/8-12	1.078	1.078	2.06	2.06	1 5/8	•	•	
24 ETX	2303-24-24	1 1/2	1 7/8-12	1 7/8-12	1.312	1.312	2.33	2.33	1 7/8	•	•	
32 ETX	2303-32-32	2	2 1/2-12	2 1/2-12	1.781	1.781	3.06	3.06	2 1/2	•	•	

*Please see page C6 for conformance to military specifications.

Union Tee JTX

Flare tube end (all three ends)

SAE 070401 MS515XX*

Part Number Information

JTX - Body only

JBTX - Body with tube nuts and sleeves

All dimensions are in inches

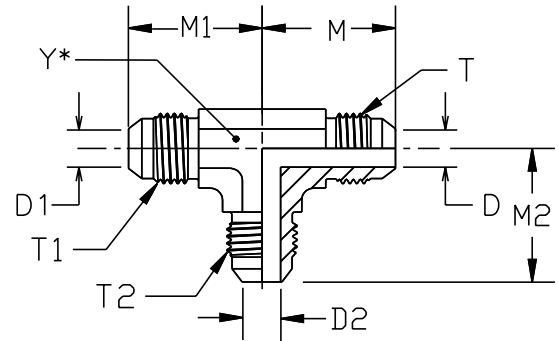

*Y—ACROSS WRENCH FLATS

TUBE FITTING PART #	HOSE FITTING PART #	TUBE O.D. (inch)	T TUBE END UN/UNF-2A	T1 TUBE END UN/UNF-2A	T2 TUBE END UN/UNF-2A	D DRILL (inch)	D1 DRILL (inch)	D2 DRILL (inch)	M (inch)	M1 (inch)	M2 (inch)	Y (inch)	STANDARD MATERIAL FROM STOCK		
													S	SS	B
2 JTX	033T-2-2	1/8	5/16-24	5/16-24	5/16-24	0.062	0.062	0.062	0.78	0.78	0.78	5/16	•	•	•
3 JTX	033T-3-3	3/16	3/8-24	3/8-24	3/8-24	0.125	0.125	0.125	0.83	0.83	0.83	7/16	•	•	•
4 JTX	033T-4-4	1/4	7/16-20	7/16-20	7/16-20	0.172	0.172	0.172	0.89	0.89	0.89	7/16	•	•	•
4-4-3 JTX	033T-3-4-4	1/4 to 3/16	7/16-20	7/16-20	3/8-24	0.172	0.172	0.125	0.89	0.89	0.81	7/16	•	•	•
5 JTX	033T-5-5	5/16	1/2-20	1/2-20	1/2-20	0.234	0.234	0.234	0.95	0.95	0.95	9/16	•	•	•
6 JTX	033T-6-6	3/8	9/16-18	9/16-18	9/16-18	0.297	0.297	0.297	1.06	1.06	1.06	9/16	•	•	•
8 JTX	033T-8-8	1/2	3/4-16	3/4-16	3/4-16	0.391	0.391	0.391	1.25	1.25	1.25	3/4	•	•	•
10 JTX	033T-10-10	5/8	7/8-14	7/8-14	7/8-14	0.484	0.484	0.484	1.45	1.45	1.45	7/8	•	•	•
12 JTX	033T-12-12	3/4	1 1/16-12	1 1/16-12	1 1/16-12	0.609	0.609	0.609	1.66	1.66	1.66	1 1/16	•	•	•
12-12-8 JTX	033T-12-12-8	3/4 to 1/2	1 1/16-12	1 1/16-12	3/4-16	0.609	0.609	0.391	1.66	1.66	1.42	1 1/16	•	•	•
12-16-12 JTX	033T-16-12-12	1 to 3/4	1 1/16-12	1 5/16-12	1 1/16-12	0.609	0.844	0.609	1.77	1.81	1.77	1 5/16	•	•	•
14 JTX	033T-14-14	7/8	1 3/16-12	1 3/16-12	1 3/16-12	0.718	0.718	0.718	1.73	1.73	1.73	1 5/16	•	•	•
16 JTX	033T-16-16	1	1 5/16-12	1 5/16-12	1 5/16-12	0.844	0.844	0.844	1.81	1.81	1.81	1 5/16	•	•	•
20 JTX	033T-20-20	1 1/4	1 5/8-12	1 5/8-12	1 5/8-12	1.078	1.078	1.078	2.06	2.06	2.06	1 5/8	•	•	•
24 JTX	033T-24-24	1 1/2	1 7/8-12	1 7/8-12	1 7/8-12	1.312	1.312	1.312	2.33	2.33	2.33	1 7/8	•	•	•
24-16-16 JTX	033T-16-24	1 1/2 to 1	1 7/8-12	1 5/16-12	1 5/16-12	1.312	0.844	0.844	2.33	2.16	2.16	1 7/8	•	•	•
32 JTX	033T-32-32	2	2 1/2-12	2 1/2-12	2 1/2-12	1.781	1.781	1.781	3.06	3.06	3.06	2 1/2	•	•	•

*Please see page C6 for conformance to military specifications.

Union Cross KTX

Flare tube end (all four ends)

SAE 070501 MS515XX*

Part Number Information

KTX - Body only

KBTX - Body with tube nuts and sleeves

All dimensions are in inches

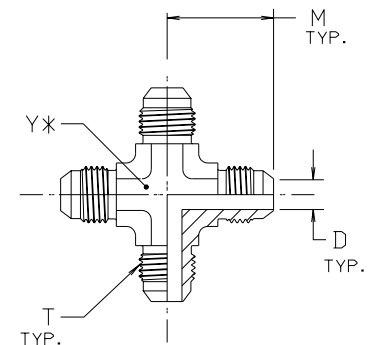

*Y—ACROSS WRENCH FLATS

TUBE FITTING PART #	HOSE FITTING PART #	TUBE O.D. (inch)	T TUBE END UN/UNF-2A	D DRILL (inch)	M (inch)	Y (inch)	STANDARD MATERIAL FROM STOCK		
							S	SS	B
4 KTX	033X-4-4	1/4	7/16-20	0.172	0.89	7/16	•	•	•
5 KTX	033X-5-5	5/16	1/2-20	0.234	0.95	9/16	•	•	•
6 KTX	033X-6-6	3/8	9/16-18	0.297	1.06	9/16	•	•	•
8 KTX	033X-8-8	1/2	3/4-16	0.391	1.25	3/4	•	•	•
10 KTX	033X-10-10	5/8	7/8-14	0.484	1.45	7/8	•	•	•
12 KTX	033X-12-12	3/4	1 1/16-12	0.609	1.66	1 1/16	•	•	•
16 KTX	033X-16-16	1	1 5/16-12	0.844	1.81	1 5/16	•	•	•

*Please see page C6 for conformance to military specifications.

Union HTX

Flare tube end / flare tube end

SAE 070101 MS515XX*

Part Number Information

HTX - Body only

HBTX - Body with tube nuts and sleeves

All dimensions are in inches

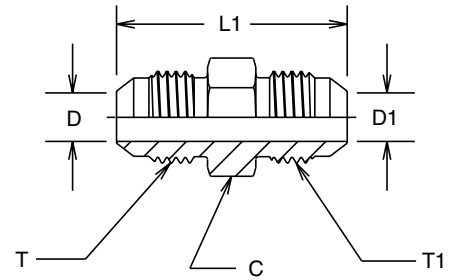

TUBE FITTING PART #	HOSE FITTING PART #	TUBE O.D. (inch)	T TUBE END UN/UNF-2A	T1 TUBE END UN/UNF-2A	C HEX (inch)	D DRILL (inch)	D1 DRILL (inch)	L1 (inch)	STANDARD MATERIAL FROM STOCK		
									S	SS	B
2 HTX	0303-2-2	1/8	5/16-24	5/16-24	7/16	0.062	0.062	1.17	•	•	•
3 HTX	0303-3-3	3/16	3/8-24	3/8-24	7/16	0.125	0.125	1.23	•	•	•
4 HTX	0303-4-4	1/4	7/16-20	7/16-20	1/2	0.172	0.172	1.38	•	•	•
4-2 HTX	0303-2-4	1/4	7/16-20	5/16-24	1/2	0.172	0.062	1.27		•	
4-3 HTX	0303-3-4	1/4	7/16-20	3/8-24	1/2	0.172	0.125	1.30		•	
5 HTX	0303-5-5	5/16	1/2-20	1/2-20	9/16	0.234	0.234	1.38	•	•	•
5-4 HTX	0303-4-5	5/16	1/2-20	7/16-20	9/16	0.234	0.172	1.38		•	
6 HTX	0303-6-6	3/8	9/16-18	9/16-18	5/8	0.297	0.297	1.41	•	•	•
6-4 HTX	0303-4-6	3/8	9/16-18	7/16-20	5/8	0.297	0.297	1.41	•	•	
6-5 HTX	0303-5-6	3/8	9/16-18	1/2-20	5/8	0.297	0.234	1.41		•	
8 HTX	0303-8-8	1/2	3/4-16	3/4-16	13/16	0.391	0.391	1.62	•	•	•
8-4 HTX	0303-4-8	1/2	3/4-16	7/16-20	13/16	0.391	0.172	1.52	•	•	
8-6 HTX	0303-6-8	1/2	3/4-16	9/16-18	13/16	0.391	0.297	1.52	•	•	
10 HTX	0303-10-10	5/8	7/8-14	7/8-14	15/16	0.484	0.484	1.88	•	•	•
10-8 HTX	0303-8-10	5/8	7/8-14	3/4-16	15/16	0.484	0.391	1.78	•	•	
12 HTX	0303-12-12	3/4	1 1/16-12	1 1/16-12	1 1/8	0.609	0.609	2.16	•	•	•
12-8 HTX	0303-8-12	3/4	1 1/16-12	3/4-16	1 1/8	0.609	0.391	1.95	•	•	
12-10 HTX	0303-10-12	3/4	1 1/16-12	7/8-14	1 1/8	0.609	0.484	2.05	•	•	
14 HTX	0303-14-14	7/8	1 3/16-12	1 3/16-12	1 1/4	0.718	0.718	2.22	•	•	•
16 HTX	0303-16-16	1	1 5/16-12	1 5/16-12	1 3/8	0.844	0.844	2.25	•	•	•
16-12 HTX	0303-12-16	1	1 5/16-12	1 1/16-12	1 3/8	0.844	0.609	2.20	•	•	
20 HTX	0303-20-20	1 1/4	1 5/8-12	1 5/8-12	1 11/16	1.078	1.078	2.44	•	•	•
24 HTX	0303-24-24	1 1/2	1 7/8-12	1 7/8-12	2	1.312	1.312	2.75	•	•	•
24-10 HTX	0303-10-24	1 1/2	1 7/8-12	7/8-14	2	1.312	0.484	2.42		•	
24-12 HTX	0303-12-24	1 1/2	1 7/8-12	1 1/16-12	2	1.312	0.609	2.53		•	
24-16 HTX	0303-16-24	1 1/2	1 7/8-12	1 5/16-12	2	1.312	0.844	2.58		•	
32 HTX	0303-32-32	2	2 1/2-12	2 1/2-12	2 5/8	1.781	1.781	3.41	•	•	•
32-24 HTX	0303-24-32	2	2 1/2-12	1 7/8-12	2 5/8	1.781	1.312	2.81		•	

*Please see page C6 for conformance to military specifications.

Large Hex Union LHTX

Flare tube end / flare tube end

SAE 070119 MS515XX*

Part Number Information

LHTX - Body only

LHBTX - Body with tube nuts and sleeves

All dimensions are in inches

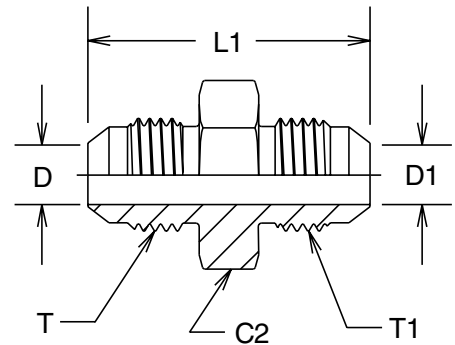

C2*—LARGE HEX ALLOWS FOR USE IN MS33649 PORT

TUBE FITTING PART #	HOSE FITTING PART #	TUBE O.D. (inch)	T TUBE END UN/UNF-2A	T1 TUBE END UN/UNF-2A	C2 HEX (inch)	D DRILL (inch)	D1 DRILL (inch)	L1 (inch)	STANDARD MATERIAL FROM STOCK		
									S	SS	B
4 LHTX	03L3--4-4	1/4	7/16-20	7/16-20	11/16	0.172	0.172	1.38	•	•	•
4-3 LHTX	03L3-3-4	1/4 to 3/16	7/16-20	3/8-24	11/16	0.172	0.125	1.30	•	•	•
5 LHTX	03L3-5-5	5/16	1/2-20	1/2-20	3/4	0.234	0.234	1.38	•	•	•
6 LHTX	03L3-6-6	3/8	9/16-18	9/16-18	13/16	0.297	0.297	1.41	•	•	•
6-4 LHTX	03L3-4-6	3/8 to 1/4	9/16-18	7/16-20	13/16	0.297	0.172	1.41	•	•	•
8 LHTX	03L3-8-8	1/2	3/4-16	3/4-16	1	0.391	0.391	1.62	•	•	•
8-4 LHTX	03L3-4-8	1/2 to 1/4	3/4-16	7/16-20	1	0.391	0.172	1.52	•	•	•
8-6 LHTX	03L3-6-8	1/2 to 3/8	3/4-16	9/16-18	1	0.391	0.297	1.52	•	•	•
10 LHTX	03L3-10-10	5/8	7/8-14	7/8-14	1 1/8	0.484	0.484	1.88	•	•	•
12 LHTX	03L3-12-12	3/4	1 1/16-12	1 1/16-12	1 3/8	0.609	0.609	2.16	•	•	•
12-8 LHTX	03L3-8-12	3/4 to 1/2	1 1/16-12	3/4-16	1 3/8	0.609	0.391	1.95	•	•	•
16 LHTX	03L3-16-16	1	1 5/16-12	1 5/16-12	1 5/8	0.844	0.844	2.25	•	•	•
32 LHTX	03L3-32-32	2	2 1/2-12	2 1/2-12	2 3/4	1.781	1.781	3.41	•	•	•

*Please see page C6 for conformance to military specifications.

Bulkhead Union Elbow WETX

Flare tube end / flare tube end

SAE 070701

Part Number Information

WETX - Body only

WEBTX - Body with locknut, tube nuts and sleeves

WETX-WLN - Body with locknut

All dimensions are in inches

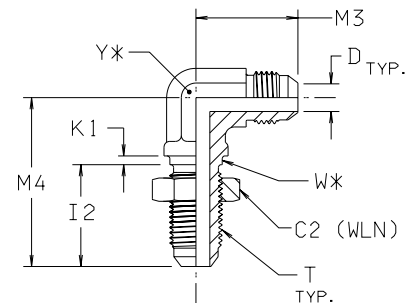

Y* — ACROSS WRENCH FLATS
W* — BULKHEAD PILOT DIA. RECOMMENDED CLEARANCE HOLE +.015 OVER W DIA.

TUBE FITTING PART #	HOSE FITTING PART #	TUBE O.D. (inch)	T TUBE END UN/UNF-2A	C2 HEX (inch)	D DRILL (inch)	I2 (inch)	K1 (inch)	M3 (inch)	M4 (inch)	W DIA (inch)	MAX BULKHEAD WALL THICKNESS (inch)	Y (inch)	STANDARD MATERIAL FROM STOCK		
													S	SS	B
3 WETX	2353-3-3N	3/16	3/8-24	5/8	0.125	0.92	0.09	0.94	1.50	0.38	0.21	7/16	•	•	•
4 WETX	2353-4-4N	1/4	7/16-20	11/16	0.172	1.02	0.09	0.97	1.59	0.44	0.21	7/16	•	•	•
5 WETX	2353-5-5N	5/16	1/2-20	3/4	0.234	1.02	0.09	1.06	1.72	0.50	0.21	9/16	•	•	•
6 WETX	2353-6-6N	3/8	9/16-18	13/16	0.297	1.09	0.09	1.09	1.81	0.56	0.28	9/16	•	•	•
8 WETX	2353-8-8N	1/2	3/4-16	1	0.391	1.25	0.13	1.36	2.11	0.75	0.33	3/4	•	•	•
10 WETX	2353-10-10N	5/8	7/8-14	1 1/8	0.484	1.39	0.13	1.56	2.39	0.88	0.32	7/8	•	•	•
12 WETX	2353-12-12N	3/4	1 1/16-12	1 3/8	0.609	1.56	0.13	1.78	2.67	1.06	0.34	1 1/16	•	•	•
14 WETX	2353-14-14N	7/8	1 3/16-12	1 1/2	0.718	1.56	0.13	1.92	2.80	1.19	0.31	1 5/8	•	•	•
16 WETX	2353-16-16N	1	1 5/16-12	1 5/8	0.844	1.56	0.13	1.94	2.80	1.31	0.29	1 5/8	•	•	•
20 WETX	2353-20-20N	1 1/4	1 5/8-12	1 7/8	1.078	1.61	0.13	2.17	3.13	1.63	0.29	1 5/8	•	•	•

Bulkhead Run Tee

WJJT_X

Flare tube end (all three ends)

SAE 070958

Part Number Information

WJJT_X - Body only

WJJB_TX - Body with locknut, tube nuts and sleeves

WJJT_X-WLN - Body with locknut

All dimensions are in inches

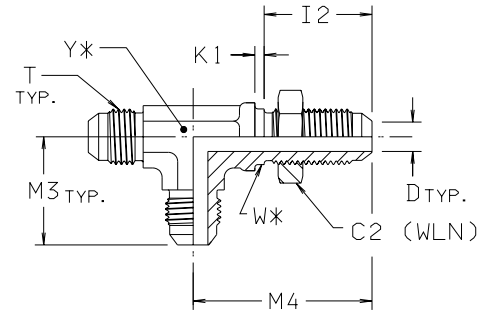

Y* — ACROSS WRENCH FLATS
W* — BULKHEAD PILOT DIA.
RECOMMENDED CLEARANCE HOLE +.015 OVER W DIA.

TUBE FITTING PART #	HOSE FITTING PART #	TUBE O.D. (inch)	T TUBE END UN/UNF-2A	C2 HEX (inch)	D DRILL (inch)	I2 (inch)	K1 (inch)	M3 (inch)	M4 (inch)	W DIA (inch)	MAX BULKHEAD WALL THICKNESS (inch)	Y (inch)	STANDARD MATERIAL FROM STOCK		
													S	SS	B
4 WJJT _X	533T-4-4N	1/4	7/16-20	11/16	0.172	1.02	0.09	0.97	1.59	0.44	0.21	7/16	•	•	
6 WJJT _X	533T-6-6N	3/8	9/16-18	13/16	0.297	1.09	0.09	1.09	1.81	0.56	0.28	9/16	•	•	
8 WJJT _X	533T-8-8N	1/2	3/4-16	1	0.391	1.25	0.13	1.36	2.11	0.75	0.33	3/4	•	•	
10 WJJT _X	533T-10-10N	5/8	7/8-14	1 1/8	0.484	1.39	0.13	1.56	2.39	0.88	0.32	7/8	•	•	
12 WJJT _X	533T-12-12N	3/4	1 1/16-12	1 3/8	0.609	1.56	0.13	1.78	2.67	1.06	0.34	1 1/16	•	•	
16 WJJT _X	533T-16-16N	1	1 5/16-12	1 5/8	0.844	1.56	0.13	1.94	2.80	1.31	0.29	1 7/16	•	•	
20 WJJT _X	533T-20-20N	1 1/4	1 5/8-12	1 7/8	1.078	1.61	0.13	2.17	3.12	1.63	0.29	1 5/8			

Bulkhead Branch Tee

WJT_X

Flare tube end (all three ends)

SAE 070959

Part Number Information

WJT_X - Body only

WJB_TX - Body with locknut, tube nuts and sleeves

WJT_X-WLN - Body with locknut

All dimensions are in inches

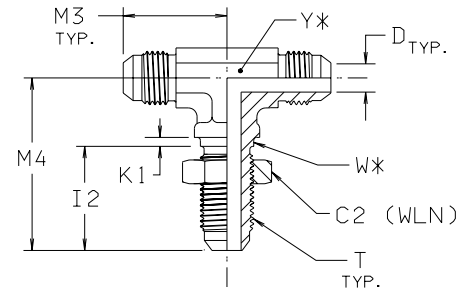

Y* — ACROSS WRENCH FLATS
W* — BULKHEAD PILOT DIA.
RECOMMENDED CLEARANCE HOLE +.015 OVER W DIA.

TUBE FITTING PART #	HOSE FITTING PART #	TUBE O.D. (inch)	T TUBE END UN/UNF-2A	C2 HEX (inch)	D DRILL (inch)	I2 (inch)	K1 (inch)	M3 (inch)	M4 (inch)	W DIA (inch)	MAX BULKHEAD WALL THICKNESS (inch)	Y (inch)	STANDARD MATERIAL FROM STOCK		
													S	SS	B
4 WJT _X	543T-4-4N	1/4	7/16-20	11/16	0.172	1.02	0.09	0.97	1.59	0.44	0.21	7/16	•	•	
6 WJT _X	543T-6-6N	3/8	9/16-18	13/16	0.297	1.09	0.09	1.09	1.81	0.56	0.28	9/16	•	•	
8 WJT _X	543T-8-8N	1/2	3/4-16	1	0.391	1.25	0.13	1.36	2.11	0.75	0.33	3/4	•	•	
** 10 WJT _X	543T-10-10N	5/8	7/8-14	1 1/8	0.484	1.39	0.13	1.56	2.39	0.88	0.32	1 1/16	•	•	
12 WJT _X	543T-12-12N	3/4	1 1/16-12	1 3/8	0.609	1.56	0.13	1.78	2.67	1.06	0.34	1 1/16	•	•	
16 WJT _X	543T-16-16N	1	1 5/16-12	1 5/8	0.844	1.56	0.13	1.94	2.80	1.31	0.29	1 5/16	•	•	
20 WJT _X	543T-20-20N	1 1/4	1 5/8-12	1 7/8	1.078	1.61	0.13	2.17	3.12	1.63	0.29	1 5/8			

** Does not meet SAE 070959

45° Bulkhead Union Elbow WNTX

Flare tube end / flare tube end

SAE 070801

Part Number Information
WNTX - Body only
WNBTX - Body with locknut, tube nuts and sleeves
WNTX-WLN - Body with locknut

All dimensions are in inches

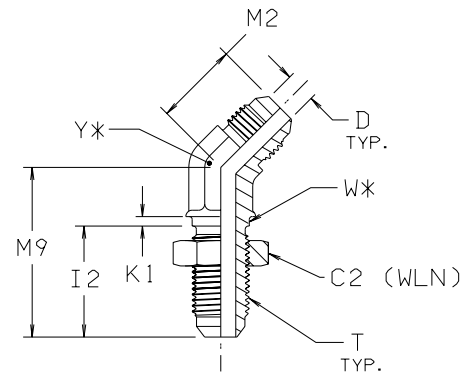

Y* — ACROSS WRENCH FLATS
W* — BULKHEAD PILOT DIA.
RECOMMENDED CLEARANCE HOLE +.015 OVER W DIA.

TUBE FITTING PART #	HOSE FITTING PART #	TUBE O.D. (inch)	T TUBE END UN/UNF-2A	C2 HEX (inch)	D DRILL (inch)	I2 (inch)	K1 (inch)	M2 (inch)	M9 (inch)	W DIA (inch)	MAX BULKHEAD WALL THICKNESS (inch)	Y (inch)	STANDARD MATERIAL FROM STOCK		
													S	SS	B
4 WNTX	3353-4-4N	1/4	7/16-20	11/16	0.172	1.02	0.09	0.72	1.53	0.44	0.21	7/16	•	•	
5 WNTX	3353-5-5N	5/16	1/2-20	3/4	0.234	1.02	0.09	0.78	1.66	0.56	0.21	9/16	•	•	
6 WNTX	3353-6-6N	3/8	9/16-18	13/16	0.297	1.09	0.09	0.83	1.67	0.56	0.28	9/16	•	•	
8 WNTX	3353-8-8N	1/2	3/4-16	1	0.391	1.25	0.13	0.98	1.94	0.75	0.33	3/4	•	•	
10 WNTX	3353-10-10N	5/8	7/8-14	1 1/8	0.484	1.39	0.13	1.11	2.17	0.82	0.32	7/8	•	•	
12 WNTX	3353-12-12N	3/4	1 1/16-12	1 3/8	0.609	1.56	0.13	1.28	2.44	1.06	0.34	1 1/16	•	•	
16 WNTX	3353-16-16N	1	1 5/16-12	1 5/8	0.844	1.56	0.13	1.47	2.56	1.31	0.29	1 5/16	•	•	
20 WNTX	3353-20-20N	1 1/4	1 5/8-12	1 7/8	1.078	1.61	0.13	1.59	2.65	1.63	0.29	1 5/8	•	•	

Bulkhead Union WTX

Flare tube end / flare tube end

SAE 070601 MS515XX*

Part Number Information
WTX - Body only
WBTX - Body with locknut, tube nuts and sleeves
WTX-WLN - Body with locknut

All dimensions are in inches

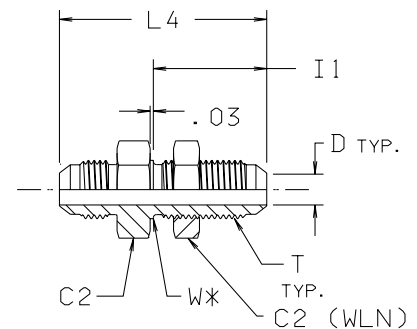

W* — BULKHEAD PILOT DIA.
RECOMMENDED CLEARANCE HOLE +.015 OVER W DIA.

TUBE FITTING PART #	HOSE FITTING PART #	TUBE O.D. (inch)	T TUBE END UN/UNF-2A	C2 HEX (inch)	D DRILL (inch)	I1 (inch)	L4 (inch)	W DIA (inch)	MAX BULKHEAD WALL THICKNESS (inch)	STANDARD MATERIAL FROM STOCK		
										S	SS	B
3 WTX	0353-3-3N	3/16	3/8-24	5/8	0.125	1.11	1.91	0.38	0.38	•	•	•
4 WTX	0353-4-4N	1/4	7/16-20	11/16	0.172	1.20	2.08	0.44	0.33	•	•	•
5 WTX	0353-5-5N	5/16	1/2-20	3/4	0.234	1.20	2.08	0.50	0.33	•	•	•
6 WTX	0353-6-6N	3/8	9/16-18	13/16	0.297	1.28	2.19	0.56	0.42	•	•	•
8 WTX	0353-8-8N	1/2	3/4-16	1	0.391	1.44	2.44	0.75	0.44	•	•	•
10 WTX	0353-10-10N	5/8	7/8-14	1 1/8	0.484	1.58	2.75	0.88	0.43	•	•	•
12 WTX	0353-12-12N	3/4	1 1/16-12	1 3/8	0.609	1.75	3.09	1.06	0.44	•	•	•
14 WTX	0353-14-14N	7/8	1 3/16-12	1 1/2	0.718	1.75	3.13	1.19	0.41	•	•	•
16 WTX	0353-16-16N	1	1 5/16-12	1 5/8	0.844	1.75	3.14	1.31	0.39	•	•	•
20 WTX	0353-20-20N	1 1/4	1 5/8-12	1 7/8	1.078	1.80	3.31	1.63	0.40	•	•	•
24 WTX	0353-24-24N	1 1/2	1 7/8-12	2 1/8	1.312	1.81	3.52	1.88	0.28	•	•	•
32 WTX	0353-32-32N	2	2 1/2-12	2 3/4	1.781	2.09	4.20	2.50	0.28	•	•	•

*Please see page C6 for conformance to military specifications.

Female Elbow DTX

Flare tube end / female pipe end

SAE 070203 MS515XX*

Part Number Information

DTX - Body only

DBTX - Body with tube nut and sleeve

All dimensions are in inches

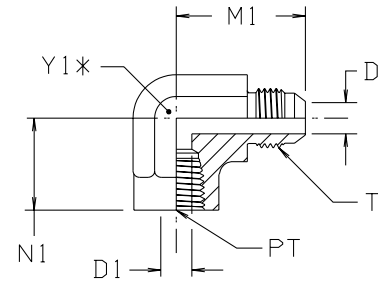

*Y1 —ACROSS WRENCH FLATS

TUBE FITTING PART #	HOSE FITTING PART #	TUBE O.D. (inch)	T TUBE END UN/UNF-2A	PT PORT THD NPTF	D DRILL (inch)	D1 DRILL REF (inch)	M1 (inch)	N1 (inch)	Y1 (inch)	STANDARD MATERIAL FROM STOCK		
										S	SS	B
4 DTX	2203-2-4	1/4	7/16-20	1/8-27	0.172	0.328	1.08	0.66	9/16	•	•	•
4-4 DTX	2203-4-4	1/4	7/16-20	1/4-18	0.172	0.422	1.22	0.88	3/4	•	•	•
5 DTX	2203-2-5	5/16	1/2-20	1/8-27	0.234	0.328	1.08	0.66	9/16	•	•	•
5-4 DTX	2203-4-5	5/16	1/2-20	1/4-18	0.234	0.422	1.13	0.88	3/4	•	•	•
6 DTX	2203-4-6	3/8	9/16-18	1/4-18	0.297	0.422	1.23	0.88	3/4	•	•	•
6-2 DTX	2203-2-6	3/8	9/16-18	1/8-27	0.297	0.328	1.23	0.67	9/16	•	•	•
6-6 DTX	2203-6-6	3/8	9/16-18	3/8-18	0.297	0.563	1.31	1.02	7/8	•	•	•
8 DTX	2203-6-8	1/2	3/4-16	3/8-18	0.391	0.563	1.42	1.02	7/8	•	•	•
8-4 DTX	2203-4-8	1/2	3/4-16	1/4-18	0.391	0.422	1.42	1.01	3/4	•	•	•
8-8 DTX	2203-8-8	1/2	3/4-16	1/2-14	0.391	0.688	1.52	1.23	1 1/16	•	•	•
10 DTX	2203-8-10	5/8	7/8-14	1/2-14	0.484	0.688	1.64	1.23	1 1/16	•	•	•
12 DTX	2203-12-12	3/4	1 1/16-12	3/4-14	0.609	0.891	1.89	1.36	1 5/16	•	•	•
12-8 DTX	2203-8-12	3/4	1 1/16-12	1/2-14	0.609	0.688	1.89	1.35	1 1/16	•	•	•
14 DTX	2203-12-14	7/8	1 3/16-12	3/4-14	0.718	0.891	1.86	1.42	1 5/16	•	•	•
16 DTX	2203-16-16	1	1 5/16-12	1-11 1/2	0.844	1.125	2.17	1.63	1 5/8	•	•	•
20 DTX	2203-20-20	1 1/4	1 5/8-12	1 1/4-11 1/2	1.078	1.469	2.33	1.70	1 7/8	•	•	•
24 DTX	2203-24-24	1 1/2	1 7/8-12	1 1/2-11 1/2	1.312	1.703	2.89	2.08	2 1/2	•	•	•

*Please see page C6 for conformance to military specifications.

Female Connector GTX

Flare tube end / female pipe end

SAE 070103 MS515XX*

Part Number Information

GTX - Body only

GBTX - Body with tube nut and sleeve

All dimensions are in inches

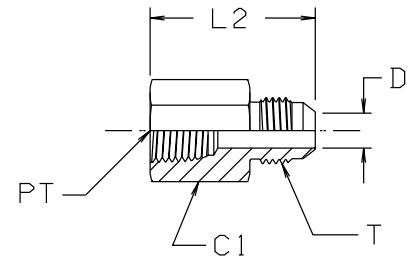

TUBE FITTING PART #	HOSE FITTING PART #	TUBE O.D. (inch)	T TUBE END UN/UNF-2A	PT PORT THD NPTF	C1 HEX (inch)	D DRILL (inch)	L2 (inch)	STANDARD MATERIAL FROM STOCK		
								S	SS	B
2 GTX	0203-2-2	1/8	5/16-24	1/8-27	9/16	0.062	1.13	•	•	•
3 GTX	0203-2-3	3/16	3/8-24	1/8-27	9/16	0.125	1.13	•	•	•
4 GTX	0203-2-4	1/4	7/16-20	1/8-27	9/16	0.172	1.19	•	•	•
4-4 GTX	0203-4-4	1/4	7/16-20	1/4-18	3/4	0.172	1.39	•	•	•
4-6 GTX	0203-6-4	1/4	7/16-20	3/8-18	7/8	0.172	1.44	•	•	•
4-8 GTX	0203-8-4	1/4	7/16-20	1/2-14	1 1/8	0.172	1.45	•	•	•
5 GTX	0203-2-5	5/16	1/2-20	1/8-27	9/16	0.234	1.17	•	•	•
5-4 GTX	0203-4-5	5/16	1/2-20	1/4-18	3/4	0.234	1.39	•	•	•
6 GTX	0203-4-6	3/8	9/16-18	1/4-18	3/4	0.297	1.41	•	•	•
6-2 GTX	0203-2-6	3/8	9/16-18	1/8-27	5/8	0.297	1.13	•	•	•
6-6 GTX	0203-6-6	3/8	9/16-18	3/8-18	7/8	0.297	1.47	•	•	•
6-8 GTX	0203-8-6	3/8	9/16-18	1/2-14	1 1/8	0.297	1.75	•	•	•
8 GTX	0203-6-8	1/2	3/4-16	3/8-18	7/8	0.391	1.56	•	•	•
8-4 GTX	0203-4-8	1/2	3/4-16	1/4-18	13/16	0.391	1.41	•	•	•
8-8 GTX	0203-8-8	1/2	3/4-16	1/2-14	1 1/8	0.391	1.79	•	•	•
8-12 GTX	0203-12-8	1/2	3/4-16	3/4-14	1 3/8	0.391	1.88	•	•	•
10 GTX	0203-8-10	5/8	7/8-14	1/2-14	1 1/8	0.484	1.89	•	•	•
10-12 GTX	0203-12-10	5/8	7/8-14	3/4-14	1 3/8	0.484	2.00	•	•	•
12 GTX	0203-12-12	3/4	1 1/16-12	3/4-14	1 3/8	0.609	2.06	•	•	•
12-8 GTX	0203-8-12	3/4	1 1/16-12	1/2-14	1 1/8	0.609	1.91	•	•	•
12-16 GTX	0203-16-12	3/4	1 1/16-12	1-11 1/2	1 5/8	0.609	2.30	•	•	•
14 GTX	0203-12-14	7/8	1 3/16-12	3/4-14	1 3/8	0.718	2.06	•	•	•
16 GTX	0203-16-16	1	1 5/16-12	1-11 1/2	1 5/8	0.844	2.34	•	•	•
16-12 GTX	0203-12-16	1	1 5/16-12	3/4-14	1 3/8	0.844	2.00	•	•	•
16-20 GTX	0203-20-16	1	1 5/16-12	1 1/4-11 1/2	2	0.844	2.43	•	•	•
20 GTX	0203-20-20	1 1/4	1 5/8-12	1 1/4-11 1/2	2	1.078	2.48	•	•	•
20-16 GTX	0203-16-20	1 1/4	1 5/8-12	1-11 1/2	1 3/4	1.078	2.47	•	•	•
24 GTX	0203-24-24	1 1/2	1 7/8-12	1 1/2-11 1/2	2 3/8	1.312	2.63	•	•	•
32 GTX	0203-32-32	2	2 1/2-12	2-11 1/2	2 7/8	1.781	2.97	•	•	•

*Please see page C6 for conformance to military specifications.

Female Bulkhead Connector

WGTX

Flare tube end / female pipe end

Part Number Information
 WGTX - Body only
 WGBTX - Body with locknut, tube nut and sleeve
 WGTX-WLN - Body with locknut

All dimensions are in inches

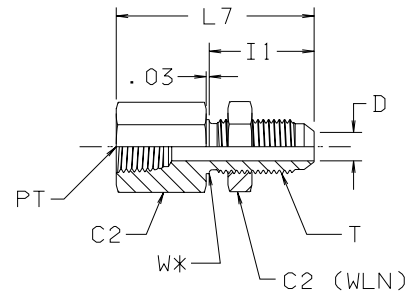

W*— BULKHEAD PILOT DIA.
 RECOMMENDED CLEARANCE
 HOLE +.015 OVER W DIA.

TUBE FITTING PART #	HOSE FITTING PART #	TUBE O.D. (inch)	T TUBE END UN/UNF-2A	PT PORT THD NPTF	C2 HEX (inch)	D DRILL (inch)	I1 (inch)	L7 (inch)	W DIA (inch)	MAX BULKHEAD WALL THICKNESS (inch)	STANDARD MATERIAL FROM STOCK		
											S	SS	B
4 WGTX	0253-2-4N	1/4	7/16-20	1/8-27	11/16	0.172	1.20	1.84	0.44	0.33	•	•	
4-4 WGTX	0253-4-4N	1/4	7/16-20	1/4-18	3/4	0.172	1.33	2.11	0.44	0.33	•	•	
6 WGTX	0253-4-6N	3/8	9/16-18	1/4-18	13/16	0.297	1.28	2.06	0.56	0.42	•	•	
6-6 WGTX	0253-6-6N	3/8	9/16-18	3/8-18	7/8	0.297	1.28	2.24	0.56	0.42	•	•	
8 WGTX	0253-6-8N	1/2	3/4-16	3/8-18	1	0.391	1.44	2.34	0.75	0.44	•	•	
8-8 WGTX	0253-8-8N	1/2	3/4-16	1/2-14	1 1/8	0.391	1.44	2.61	0.75	0.44	•	•	
10 WGTX	0253-8-10N	5/8	7/8-14	1/2-14	1 1/8	0.484	1.58	2.66	0.88	0.43	•	•	
12 WGTX	0253-12-12N	3/4	1 1/16-12	3/4-14	1 3/8	0.609	1.75	2.91	1.06	0.44	•	•	
14 WGTX	0253-12-14N	7/8	1 3/16-12	3/4-14	1 1/2	0.718	1.75	2.89	1.19	0.41	•		
16 WGTX	0253-16-16N	1	1 5/16-12	1-11 1/2	1 5/8	0.844	1.75	3.09	1.31	0.39	•		
24 WGTX	0253-24-24N	1 1/2	1 7/8-12	1 1/2-11 1/2	2 1/4	1.312	1.81	3.35	1.88	0.28	•		

Female Run Tee

MTX

Flare tube ends / female pipe end

SAE 070426
 Part Number Information
 MTX - Body only
 MBTX - Body with tube nuts and sleeves

All dimensions are in inches

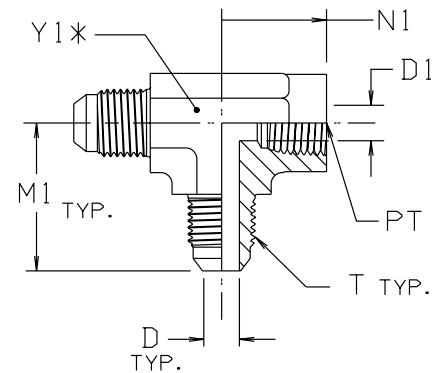

*Y1 — ACROSS WRENCH FLATS

TUBE FITTING PART #	HOSE FITTING PART #	TUBE O.D. (inch)	T TUBE END UN/UNF-2A	PT PORT THD NPTF	D DRILL (inch)	D1 DRILL REF (inch)	M1 (inch)	N1 (inch)	Y1 (inch)	STANDARD MATERIAL FROM STOCK		
										S	SS	B
4 MTX	023T-2-4	1/4	7/16-20	1/8-27	0.172	0.328	1.08	0.66	9/16	•	•	•
4-4 MTX	023T-4-4-4	1/4	7/16-20	1/4-18	0.172	0.422	1.13	0.88	3/4	•	•	•
6 MTX	023T-4-6	3/8	9/16-18	1/4-18	0.297	0.422	1.24	0.88	3/4	•	•	•
8 MTX	023T-6-8	1/2	3/4-16	3/8-18	0.391	0.563	1.42	1.02	7/8	•	•	•
8-8 MTX	023T-8-8-8	1/2	3/4-16	1/2-14	0.391	0.688	1.42	1.23	1 1/16	•	•	•
10 MTX	023T-8-10	5/8	7/8-14	1/2-14	0.484	0.688	1.64	1.24	1 1/16	•	•	
12 MTX	023T-12-12	3/4	1 1/16-12	3/4-14	0.609	0.891	1.89	1.36	1 5/16	•	•	
14 MTX	023T-12-14	7/8	1 3/16-12	3/4-14	0.718	0.891	1.86	1.42	1 5/16	•		
16 MTX	023T-16-16	1	1 5/16-12	1-11 1/2	0.844	1.125	2.17	1.63	1 5/8	•		
20 MTX	023T-20-20	1 1/4	1 5/8-12	1 1/4-11 1/2	1.078	1.469	2.33	1.70	1 7/8	•		
24 MTX	023T-24-24	1 1/2	1 7/8-12	1 1/2-11 1/2	1.312	1.703	2.89	2.08	2 1/2			

Female Branch Tee OTX

Flare tube end / female pipe end

SAE 070427

Part Number Information

OTX - Body only

OBTX - Body with tube nuts and sleeves

All dimensions are in inches

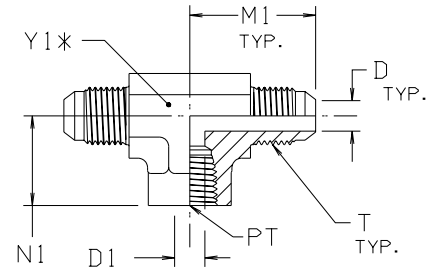

*Y1 — ACROSS WRENCH FLATS



TUBE FITTING PART #	HOSE FITTING PART #	TUBE O.D. (inch)	T TUBE END UN/UNF-2A	PT PORT THD NPTF	D DRILL (inch)	D1 DRILL REF (inch)	M1 (inch)	N1 (inch)	Y1 (inch)	STANDARD MATERIAL FROM STOCK		
										S	SS	B
4 OTX	223T-2-4	1/4	7/16-20	1/8-27	0.172	0.328	1.08	0.66	9/16	•	•	•
4-4-4 OTX	223T-4-4-4	1/4	7/16-20	1/4-18	0.172	0.422	1.13	0.88	3/4	•	•	•
5 OTX	223T-2-5	5/16	1/2-20	1/8-27	0.234	0.328	1.08	0.66	9/16	•	•	•
6 OTX	223T-4-6	3/8	9/16-18	1/4-18	0.297	0.422	1.24	0.88	3/4	•	•	•
6-6-6 OTX	223T-6-6-6	3/8	9/16-18	3/8-18	0.297	0.563	1.23	1.02	7/8	•	•	•
8 OTX	223T-6-8	1/2	3/4-16	3/8-18	0.391	0.563	1.42	1.02	7/8	•	•	•
8-8-8 OTX	223T-8-8-8	1/2	3/4-16	1/2-14	0.391	0.688	1.42	1.23	1 1/16	•	•	•
10 OTX	223T-8-10	5/8	7/8-14	1/2-14	0.484	0.688	1.64	1.24	1 1/16	•	•	•
12 OTX	223T-12-12	3/4	1 1/16-12	3/4-14	0.609	0.891	1.89	1.36	1 5/16	•	•	•
14 OTX	223T-12-14	7/8	1 3/16-12	3/4-14	0.718	0.891	1.86	1.42	1 5/16	•	•	•
16 OTX	223T-16-16	1	1 5/16-12	1-11 1/2	0.844	1.125	2.17	1.63	1 5/8	•	•	•
20 OTX	223T-20-20	1 1/4	1 5/8-12	1 1/4-11 1/2	1.078	1.469	2.33	1.70	1 7/8	•	•	•
24 OTX	223T-24-24	1 1/2	1 7/8-12	1 1/2-11 1/2	1.312	1.703	2.89	2.08	2 1/2	•	•	•

Swivel Nut Elbow C6X

Flare tube end / swivel nut end

SAE 070221 MS515XX*

Part Number Information

C6X - Body only

C6BX - Body with tube nut and sleeve

All dimensions are in inches

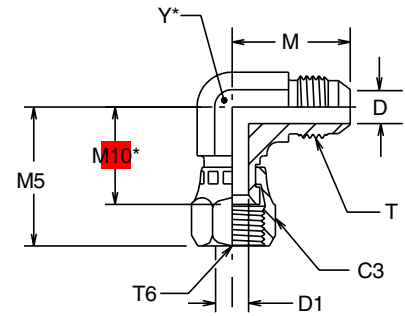

Y* — ACROSS WRENCH FLATS

M10* — CENTER TO BASE OF FLARE SEAT

TUBE FITTING PART #	HOSE FITTING PART #	TUBE O.D. (inch)	T TUBE END UN/UNF-2A	T6 SWIVEL UN/UNF-2B	C3 HEX (inch)	D DRILL (inch)	D1 DRILL (inch)	M (inch)	M5 (inch)	M10 (inch)	Y (inch)	STANDARD MATERIAL FROM STOCK		
												S	SS	B
3 C6X	3903-3-3	3/16	3/8-24	3/8-24	1/2	0.125	0.125	0.83	1.00	0.63	7/16	•	•	
4 C6X	3903-4-4	1/4	7/16-20	7/16-20	9/16	0.172	0.172	0.89	1.00	0.66	7/16	•	•	
5 C6X	3903-5-5	5/16	1/2-20	1/2-20	5/8	0.234	0.234	0.95	1.06	0.78	9/16	•		
6 C6X	3903-6-6	3/8	9/16-18	9/16-18	11/16	0.297	0.297	1.06	1.25	0.88	9/16	•	•	
8 C6X	3903-8-8	1/2	3/4-16	3/4-16	7/8	0.391	0.391	1.25	1.38	0.95	3/4	•	•	
10 C6X	3903-10-10	5/8	7/8-14	7/8-14	1	0.484	0.484	1.45	1.62	1.13	7/8	•	•	
12 C6X	3903-12-12	3/4	1 1/16-12	1 1/16-12	1 1/4	0.609	0.609	1.66	1.75	1.19	1 3/16	•	•	
12-24 C6X	3903-24-12	3/4	1 1/16-12	1 7/8-12	2 1/4	0.609	1.312	2.11	2.59	1.86	1 7/8		•	
14 C6X	3903-14-14	7/8	1 3/16-12	1 3/16-12	1 3/8	0.718	0.718	1.80	1.78	1.33	1 5/16	•		
16 C6X	3903-16-16	1	1 5/16-12	1 5/16-12	1 1/2	0.844	0.844	1.81	2.00	1.41	1 5/16	•	•	
16-12 C6X	3903-12-16	1	1 5/16-12	1 1/16-12	1 1/4	0.844	0.609	1.81	1.87	1.31	1 5/16		•	
20 C6X	3903-20-20	1 1/4	1 5/8-12	1 5/8-12	2	1.078	1.078	2.06	2.31	1.69	1 5/8	•	•	
24 C6X	3903-24-24	1 1/2	1 7/8-12	1 7/8-12	2 1/4	1.312	1.312	2.33	2.59	1.86	1 7/8	•	•	
32 C6X	3903-32-32	2	2 1/2-12	2 1/2-12	2 7/8	1.781	1.781	3.06	3.51	2.44	2 1/2	•	•	

*Please see page C6 for conformance to military specifications.

Swivel Nut Run Tee R6X

Flare tube ends / swivel nut end

SAE 070432 MS515XX*

Part Number Information

R6X - Body only

R6BX - Body with tube nuts and sleeves

All dimensions are in inches

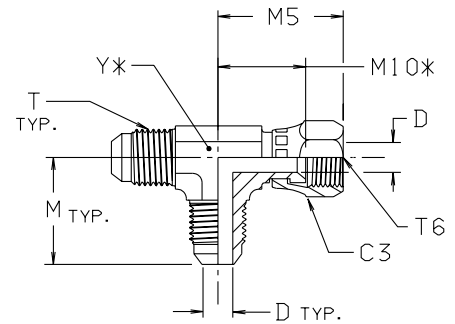

Y* — ACROSS WRENCH FLATS

M10* — CENTER TO BASE OF FLARE SEAT

TUBE FITTING PART #	HOSE FITTING PART #	TUBE O.D. (inch)	T TUBE END UN/UNF-2A	T6 SWIVEL UN/UNF-2B	C3 HEX (inch)	D DRILL (inch)	M (inch)	M5 (inch)	M10 (inch)	Y (inch)	STANDARD MATERIAL FROM STOCK		
											S	SS	B
4 R6X	063T-4-4	1/4	7/16-20	7/16-20	9/16	0.172	0.89	1.00	0.66	7/16	•	•	
5 R6X	063T-5-5	5/16	1/2-20	1/2-20	5/8	0.234	0.95	1.06	0.78	9/16	•	•	
6 R6X	063T-6-6	3/8	9/16-18	9/16-18	11/16	0.297	1.06	1.25	0.88	9/16	•	•	
8 R6X	063T-8-8	1/2	3/4-16	3/4-16	7/8	0.391	1.25	1.38	0.95	3/4	•	•	
10 R6X	063T-10-10	5/8	7/8-14	7/8-14	1	0.484	1.45	1.62	1.13	7/8	•	•	
12 R6X	063T-12-12	3/4	1 1/16-12	1 1/16-12	1 1/4	0.609	1.66	1.75	1.19	1 1/16	•	•	
14 R6X	063T-14-14	7/8	1 3/16-12	1 3/16-12	1 3/8	0.718	1.80	1.78	1.33	1 5/16	•		
16 R6X	063T-16-16	1	1 5/16-12	1 5/16-12	1 1/2	0.844	1.81	2.00	1.41	1 5/16	•	•	
20 R6X	063T-20-20	1 1/4	1 5/8-12	1 5/8-12	2	1.078	2.06	2.31	1.69	1 5/8	•	•	
24 R6X	063T-24-24	1 1/2	1 7/8-12	1 7/8-12	2 1/4	1.312	2.33	2.59	1.86	1 7/8	•	•	

*Please see page C6 for conformance to military specifications.

Swivel Nut Branch Tee S6X

Flare tube ends / swivel nut end

SAE 070433 MS515XX*

Part Number Information

S6X - Body only

S6BX - Body with tube nuts and sleeves

All dimensions are in inches

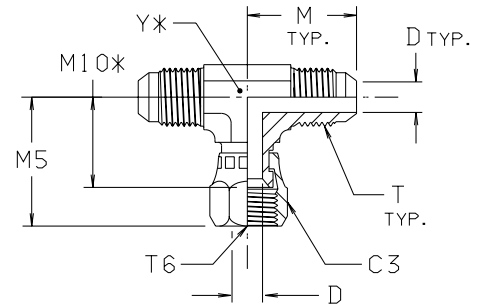

Y* — ACROSS WRENCH FLATS

M10* — CENTER TO BASE OF FLARE SEAT

TUBE FITTING PART #	HOSE FITTING PART #	TUBE O.D. (inch)	T TUBE END UN/UNF-2A	T6 SWIVEL UN/UNF-2B	C3 HEX (inch)	D DRILL (inch)	M (inch)	M5 (inch)	M10 (inch)	Y (inch)	STANDARD MATERIAL FROM STOCK		
											S	SS	B
4 S6X	393T-4-4	1/4	7/16-20	7/16-20	9/16	0.172	0.89	1.00	0.66	7/16	•	•	
5 S6X	393T-5-5	5/16	1/2-20	1/2-20	5/8	0.234	0.95	1.16	0.68	9/16	•	•	
6 S6X	393T-6-6	3/8	9/16-18	9/16-18	11/16	0.297	1.06	1.25	0.88	9/16	•	•	
8 S6X	393T-8-8	1/2	3/4-16	3/4-16	7/8	0.391	1.25	1.38	0.95	3/4	•	•	
10 S6X	393T-10-10	5/8	7/8-14	7/8-14	1	0.484	1.45	1.62	1.13	7/8	•	•	
12 S6X	393T-12-12	3/4	1 1/16-12	1 1/16-12	1 1/4	0.609	1.66	1.75	1.19	1 1/16	•	•	
14 S6X	393T-14-14	7/8	1 3/16-12	1 3/16-12	1 3/8	0.718	1.80	1.78	1.33	1 5/16	•	•	
16 S6X	393T-16-16	1	1 5/16-12	1 5/16-12	1 1/2	0.844	1.81	2.00	1.41	1 5/16	•	•	
20 S6X	393T-20-20	1 1/4	1 5/8-12	1 5/8-12	2	1.078	2.06	2.31	1.69	1 5/8	•	•	
24 S6X	393T-24-24	1 1/2	1 7/8-12	1 7/8-12	2 1/4	1.312	2.33	2.67	1.92	1 7/8	•	•	

*Please see page C6 for conformance to military specifications.

45° Swivel Nut Elbow V6X

Flare tube end / swivel nut end

SAE 070321 MS515XX*

Part Number Information

V6X - Body only

V6BX - Body with tube nut and sleeve

All dimensions are in inches

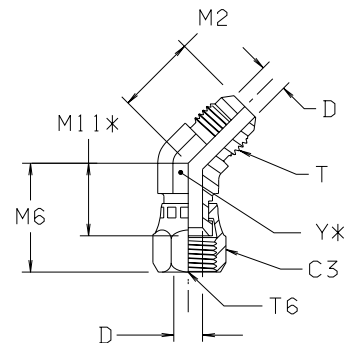

Y* — ACROSS WRENCH FLATS

M11* — CENTER TO BASE OF FLARE SEAT

TUBE FITTING PART #	HOSE FITTING PART #	TUBE O.D. (inch)	T TUBE END UN/UNF-2A	T6 SWIVEL UN/UNF-2B	C3 HEX (inch)	D DRILL (inch)	M2 (inch)	M6 (inch)	M11 (inch)	Y (inch)	STANDARD MATERIAL FROM STOCK		
											S	SS	B
4 V6X	3703-4-4	1/4	7/16-20	7/16-20	9/16	0.172	0.72	0.94	0.59	7/16	•	•	
5 V6X	3703-5-5	5/16	1/2-20	1/2-20	5/8	0.234	0.77	1.00	0.63	9/16	•	•	
6 V6X	3703-6-6	3/8	9/16-18	9/16-18	11/16	0.297	0.83	1.12	0.75	9/16	•	•	
8 V6X	3703-8-8	1/2	3/4-16	3/4-16	7/8	0.391	0.98	1.28	0.86	3/4	•	•	
10 V6X	3703-10-10	5/8	7/8-14	7/8-14	1	0.484	1.11	1.44	0.94	7/8	•	•	
12 V6X	3703-12-12	3/4	1 1/16-12	1 1/16-12	1 1/4	0.609	1.28	1.50	0.94	1 3/16	•	•	
14 V6X	3703-14-14	7/8	1 3/16-12	1 3/16-12	1 3/8	0.718	1.39	1.62	1.09	1 3/16	•	•	
16 V6X	3703-16-16	1	1 5/16-12	1 5/16-12	1 1/2	0.844	1.47	1.75	1.16	1 5/16	•	•	
20 V6X	3703-20-20	1 1/4	1 5/8-12	1 5/8-12	2	1.078	1.59	2.03	1.41	1 5/8	•	•	
24 V6X	3703-24-24	1 1/2	1 7/8-12	1 7/8-12	2 1/4	1.312	1.78	2.27	1.52	1 7/8	•	•	
32 V6X	3703-32-32	2	2 1/2-12	2 1/2-12	2 7/8	1.781	2.22	2.76	1.97	2 1/2	•	•	

*Please see page C6 for conformance to military specifications.

Extra Long Male Elbow CCCTX

Flare tube end / extra long male pipe end

SAE 071602

Part Number Information

CCCTX - Body only

CCCBTX - Body with tube nut and sleeve

All dimensions are in inches

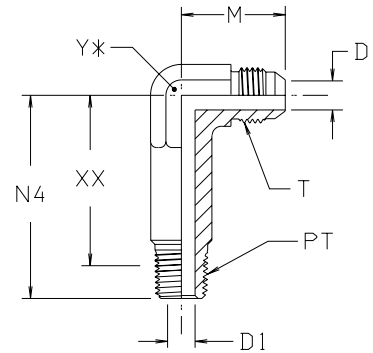

*Y — ACROSS WRENCH FLATS

TUBE FITTING PART #	HOSE FITTING PART #	TUBE O.D. (inch)	T TUBE END UN/UNF-2A	PT PORT THD NPTF	D DRILL (inch)	D1 DRILL (inch)	M (inch)	N4 (inch)	XX AFTER ASSY (inch)	Y (inch)	STANDARD MATERIAL FROM STOCK		
											S	SS	B
4 CCCTX	5703-2-4	1/4	7/16-20	1/8-27	0.172	0.188	0.89	1.56	1.36	7/16	•		•
4-4 CCCTX	5703-4-4	1/4	7/16-20	1/4-18	0.172	0.281	1.05	2.03	1.69	9/16	•		
5 CCCTX	5703-2-5	5/16	1/2-20	1/8-27	0.234	0.188	0.97	1.63	1.40	9/16	•		
6 CCCTX	5703-4-6	3/8	9/16-18	1/4-18	0.297	0.281	1.06	2.07	1.69	9/16	•		•
6-6 CCCTX	5703-6-6	3/8	9/16-18	3/8-18	0.297	0.406	1.14	2.34	1.99	3/4	•		
8 CCCTX	5703-6-8	1/2	3/4-16	3/8-18	0.391	0.406	1.25	2.34	1.99	3/4	•		
8-8 CCTX	5703-8-8	1/2	3/4-16	1/2-14	0.391	0.531	1.34	2.84	2.38	7/8	•		
10 CCCTX	5703-8-10	5/8	7/8-14	1/2-14	0.484	0.531	1.45	2.84	2.38	7/8	•		
12 CCCTX	5703-12-12	3/4	1 1/16-12	3/4-14	0.609	0.719	1.66	3.22	2.74	1 1/16	•		
16 CCCTX	5703-16-16	1	1 5/16-12	1-11 1/2	0.844	0.938	1.81	3.97	3.40	1 5/16	•		
20 CCCTX	5703-20-20	1 1/4	1 5/8-12	1 1/4-11 1/2	1.078	1.250	2.06	4.94	4.46	1 5/8	•		

Long Male Elbow CCTX

Flare tube end / long male pipe end

SAE 071502

Part Number Information

CCTX - Body only

CCBCTX - Body with tube nut and sleeve

All dimensions are in inches

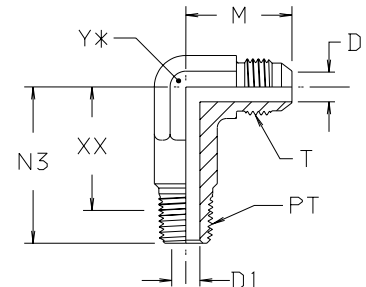

*Y — ACROSS WRENCH FLATS

TUBE FITTING PART #	HOSE FITTING PART #	TUBE O.D. (inch)	T TUBE END UN/UNF-2A	PT PORT THD NPTF	D DRILL (inch)	D1 DRILL (inch)	M (inch)	N3 (inch)	XX AFTER ASSY (inch)	Y (inch)	STANDARD MATERIAL FROM STOCK		
											S	SS	B
4 CCTX	5603-2-4	1/4	7/16-20	1/8-27	0.172	0.188	0.89	1.19	0.96	7/16	•	•	•
4-4 CCTX	5603-4-4	1/4	7/16-20	1/4-18	0.172	0.281	1.05	1.44	1.10	9/16	•	•	
5 CCTX	5603-2-5	5/16	1/2-20	1/8-27	0.234	0.188	0.95	1.17	0.94	9/16	•		
6 CCTX	5603-4-6	3/8	9/16-18	1/4-18	0.297	0.281	1.06	1.56	1.22	9/16	•	•	•
6-6 CCTX	5603-6-6	3/8	9/16-18	3/8-18	0.297	0.406	1.14	1.81	1.20	3/4	•	•	
8 CCTX	5603-6-8	1/2	3/4-16	3/8-18	0.391	0.406	1.25	1.78	1.17	3/4	•		
8-8 CCTX	5603-8-8	1/2	3/4-12	1/2-14	0.391	0.531	1.34	2.16	1.69	7/8	•	•	
8-12 CCTX	5603-12-8	1/2	3/4-12	3/4-14	0.391	0.719	1.42	2.44	1.96	1 1/16	•		
10 CCTX	5603-8-10	5/8	7/8-14	1/2-14	0.484	0.531	1.45	2.16	1.70	7/8	•	•	
12 CCTX	5603-12-12	3/4	1 1/16-12	3/4-14	0.609	0.719	1.66	2.41	1.93	1 1/16	•	•	
14 CCTX	5603-14-14	7/8	1 3/16-12	3/4-14	0.718	0.719	1.80	2.59	2.11	1 5/16	•		
16 CCTX	5603-16-16	1	1 5/16-12	1-11 1/2	0.844	0.938	1.81	2.97	2.35	1 5/16	•	•	
20 CCTX	5603-20-20	1 1/4	1 5/8-12	1 1/4-11 1/2	1.078	1.250	2.06	3.66	3.07	1 5/8	•	•	

Male Elbow CTX

Flare tube end / male pipe end

SAE 070202 MS515XX*

Part Number Information

CTX - Body only

CBTX - Body with tube nut and sleeve

All dimensions are in inches

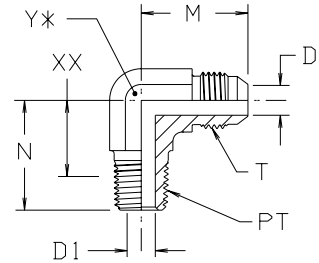

*Y — ACROSS WRENCH FLATS



TUBE FITTING PART #	HOSE FITTING PART #	TUBE O.D. (inch)	T TUBE END UN/UNF-2A	PT PORT THD NPTF	D DRILL (inch)	D1 DRILL (inch)	M (inch)	N (inch)	XX AFTER ASSY (inch)	Y (inch)	STANDARD MATERIAL FROM STOCK		
											S	SS	B
2 CTX	2103-2-2	1/8	5/16-24	1/8-27	0.062	0.188	0.77	0.72	0.49	5/16	•	•	•
3 CTX	2103-2-3	3/16	3/8-24	1/8-27	0.125	0.188	0.83	0.72	0.49	3/8	•	•	•
4 CTX	2103-2-4	1/4	7/16-20	1/8-27	0.172	0.188	0.89	0.78	0.55	7/16	•	•	•
4-4 CTX	2103-4-4	1/4	7/16-20	1/4-18	0.172	0.281	1.05	1.09	0.75	9/16	•	•	•
4-6 CTX	2103-6-4	1/4	7/16-20	3/8-18	0.172	0.406	1.13	1.22	0.87	3/4	•	•	•
4-8 CTX	2103-8-4	1/4	7/16-20	1/2-14	0.172	0.531	1.23	1.44	0.97	7/8	•	•	•
5 CTX	2103-2-5	5/16	1/2-20	1/8-27	0.234	0.188	0.95	0.78	0.55	9/16	•	•	•
5-4 CTX	2103-4-5	5/16	1/2-20	1/4-18	0.234	0.281	1.05	1.09	0.75	9/16	•	•	•
5-6 CTX	2103-6-5	5/16	1/2-20	3/8-18	0.234	0.406	1.13	1.22	0.88	3/4	•	•	•
6 CTX	2103-4-6	3/8	9/16-18	1/4-18	0.297	0.281	1.06	1.09	0.75	9/16	•	•	•
6-2 CTX	2103-2-6	3/8	9/16-18	1/8-27	0.297	0.188	1.06	0.90	0.67	9/16	•	•	•
6-6 CTX	2103-6-6	3/8	9/16-18	3/8-18	0.297	0.406	1.14	1.22	0.87	3/4	•	•	•
6-8 CTX	2103-8-6	3/8	9/16-18	1/2-14	0.297	0.531	1.22	1.47	1.01	7/8	•	•	•
6-12 CTX	2103-12-6	3/8	9/16-18	3/4-14	0.297	0.719	1.31	1.59	1.11	1 1/16	•	•	•
8 CTX	2103-6-8	1/2	3/4-16	3/8-18	0.391	0.406	1.25	1.22	0.87	3/4	•	•	•
8-4 CTX	2103-4-8	1/2	3/4-16	1/4-18	0.391	0.281	1.25	1.22	0.88	3/4	•	•	•
8-8 CTX	2103-8-8	1/2	3/4-16	1/2-14	0.391	0.531	1.33	1.47	1.01	7/8	•	•	•
8-12 CTX	2103-12-8	1/2	3/4-16	3/4-14	0.391	0.719	1.42	1.59	1.11	1 1/16	•	•	•
8-16 CTX	2103-16-8	1/2	3/4-16	1-11 1/2	0.391	0.938	1.52	1.97	1.39	1 5/16	•	•	•
10 CTX	2103-8-10	5/8	7/8-14	1/2-14	0.484	0.531	1.45	1.47	1.01	7/8	•	•	•
10-6 CTX	2103-6-10	5/8	7/8-14	3/8-18	0.484	0.406	1.45	1.28	0.93	7/8	•	•	•
10-12 CTX	2103-12-10	5/8	7/8-14	3/4-14	0.484	0.719	1.53	1.59	1.11	1 1/16	•	•	•
10-16 CTX	2103-16-10	5/8	7/8-14	1-11 1/2	0.484	0.938	1.64	1.97	1.39	1 5/16	•	•	•
12 CTX	2103-12-12	3/4	1 1/16-12	3/4-14	0.609	0.719	1.66	1.59	1.11	1 1/16	•	•	•
12-6 CTX	2103-6-12	3/4	1 1/16-12	3/8-18	0.609	0.406	1.66	1.41	0.93	1 1/16	•	•	•
12-8 CTX	2103-8-12	3/4	1 1/16-12	1/2-14	0.609	0.531	1.66	1.59	1.13	1 1/16	•	•	•
12-16 CTX	2103-16-12	3/4	1 1/16-12	1-11 1/2	0.609	0.938	1.76	1.97	1.39	1 5/16	•	•	•
14 CTX	2103-12-14	7/8	1 3/16-12	3/4-14	0.718	0.719	1.80	1.69	1.21	1 5/16	•	•	•
16 CTX	2103-16-16	1	1 5/16-12	1-11 1/2	0.844	0.938	1.81	1.97	1.40	1 5/16	•	•	•
16-8 CTX	2103-8-16	1	1 5/16-12	1/2-14	0.844	0.531	1.81	1.66	1.20	1 5/16	•	•	•
16-12 CTX	2103-12-16	1	1 5/16-12	3/4-14	0.844	0.719	1.81	1.78	1.30	1 5/16	•	•	•
16-20 CTX	2103-20-16	1	1 5/16-12	1 1/4-11 1/2	0.844	1.250	2.13	2.38	1.78	1 5/8	•	•	•
20 CTX	2103-20-20	1 1/4	1 5/8-12	1 1/4-11 1/2	1.078	1.250	2.06	2.38	1.79	1 5/8	•	•	•
20-16 CTX	2103-16-20	1 1/4	1 5/8-12	1-11 1/2	1.078	0.938	2.06	2.06	1.49	1 5/8	•	•	•
20-24 CTX	2103-24-20	1 1/4	1 5/8-12	1 1/2-11 1/2	1.078	1.500	2.20	2.64	2.05	1 7/8	•	•	•
24 CTX	2103-24-24	1 1/2	1 7/8-12	1 1/2-11 1/2	1.312	1.500	2.33	2.64	2.05	1 7/8	•	•	•
24-20 CTX	2103-20-24	1 1/2	1 7/8-12	1 1/4-11 1/2	1.312	1.250	2.33	2.25	1.66	1 7/8	•	•	•
24-32 CTX	2103-32-24	1 1/2	1 7/8-12	2-11 1/2	1.312	1.938	2.81	3.00	2.39	2 1/2	•	•	•
32 CTX	2103-32-32	2	2 1/2-12	2-11 1/2	1.781	1.938	3.06	3.00	2.39	2 1/2	•	•	•
32-24 CTX	2103-24-32	2	2 1/2-12	1 1/2-11 1/2	1.781	1.500	3.06	2.97	2.38	2 1/2	•	•	•
40 CTX	2103-40-40	2 1/2	3-12	2 1/2-8	2.281	2.312	2.86	3.57	2.66	3 1/4	•	•	•

*Please see page C6 for conformance to military specifications.

Male Connector

FTX

Flare tube end / male pipe end

SAE 070102 MS515XX*

Part Number Information

FTX - Body only

FBTX - Body with tube nut and sleeve

All dimensions are in inches

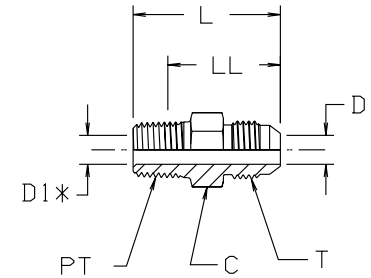

*D MAY BE SUBSTITUTED FOR D1 WHERE D IS SMALLER THAN D1

TUBE FITTING PART #	HOSE FITTING PART #	TUBE O.D. (inch)	T TUBE END UN/UNF-2A	PT PORT THD NPTF	C HEX (inch)	D DRILL (inch)	D1 DRILL (inch)	L (inch)	LL AFTER ASSY (inch)	STANDARD MATERIAL FROM STOCK		
										S	SS	B
2 FTX	0103-2-2	1/8	5/16-24	1/8-27	7/16	0.062	0.188	1.11	0.88	•	•	•
3 FTX	0103-2-3	3/16	3/8-24	1/8-27	7/16	0.125	0.188	1.14	0.91	•	•	•
4 FTX	0103-2-4	1/4	7/16-20	1/8-27	1/2	0.172	0.188	1.22	0.99	•	•	•
4-4 FTX	0103-4-4	1/4	7/16-20	1/4-18	9/16	0.172	0.281	1.42	1.08	•	•	•
4-6 FTX	0103-6-4	1/4	7/16-20	3/8-18	3/4	0.172	0.406	1.44	1.09	•	•	•
4-8 FTX	0103-8-4	1/4	7/16-20	1/2-14	7/8	0.172	0.531	1.69	1.23	•	•	•
5 FTX	0103-2-5	5/16	1/2-20	1/8-27	9/16	0.234	0.188	1.22	0.99	•	•	•
5-4 FTX	0103-4-5	5/16	1/2-20	1/4-18	9/16	0.234	0.281	1.42	1.08	•	•	•
5-6 FTX	0103-6-5	5/16	1/2-20	3/8-18	3/4	0.234	0.406	1.44	1.09	•	•	•
6 FTX	0103-4-6	3/8	9/16-18	1/4-18	5/8	0.297	0.281	1.43	1.09	•	•	•
6-2 FTX	0103-2-6	3/8	9/16-18	1/8-27	5/8	0.297	0.188	1.24	1.01	•	•	•
6-6 FTX	0103-6-6	3/8	9/16-18	3/8-18	3/4	0.297	0.406	1.44	1.09	•	•	•
6-8 FTX	0103-8-6	3/8	9/16-18	1/2-14	7/8	0.297	0.531	1.69	1.23	•	•	•
6-12 FTX	0103-12-6	3/8	9/16-18	3/4-14	1 1/8	0.297	0.719	1.75	1.27	•	•	•
8 FTX	0103-6-8	1/2	3/4-16	3/8-18	13/16	0.391	0.406	1.53	1.18	•	•	•
8-2 FTX	0103-2-8	1/2	3/4-16	1/8-27	1 3/16	0.391	0.188	1.34	1.11	•	•	•
8-4 FTX	0103-4-8	1/2	3/4-16	1/4-18	13/16	0.391	0.281	1.53	1.19	•	•	•
8-8 FTX	0103-8-8	1/2	3/4-16	1/2-14	7/8	0.391	0.531	1.78	1.32	•	•	•
8-12 FTX	0103-12-8	1/2	3/4-16	3/4-14	1 1/8	0.391	0.719	1.85	1.37	•	•	•
8-16 FTX	0103-16-8	1/2	3/4-16	1-11 1/2	1 3/8	0.391	0.938	2.05	1.48	•	•	•
10 FTX	0103-8-10	5/8	7/8-14	1/2-14	15/16	0.484	0.531	1.89	1.43	•	•	•
10-6 FTX	0103-6-10	5/8	7/8-14	3/8-18	15/16	0.484	0.406	1.70	1.35	•	•	•
10-12 FTX	0103-12-10	5/8	7/8-14	3/4-14	1 1/8	0.484	0.719	1.95	1.47	•	•	•
12 FTX	0103-12-12	3/4	1 1/16-12	3/4-14	1 1/8	0.609	0.719	2.06	1.58	•	•	•
12-6 FTX	0103-6-12	3/4	1 1/16-12	3/8-18	1 1/8	0.609	0.406	1.88	1.53	•	•	•
12-8 FTX	0103-8-12	3/4	1 1/16-12	1/2-14	1 1/8	0.609	0.531	2.06	1.60	•	•	•
12-16 FTX	0103-16-12	3/4	1 1/16-12	1-11 1/2	1 3/8	0.609	0.938	2.25	1.68	•	•	•
12-20 FTX	0103-20-12	3/4	1 1/16-12	1 1/4-11 1/2	1 11/16	0.609	1.25	2.36	1.77	•	•	•
14 FTX	0103-12-14	7/8	1 3/16-12	3/4-14	1 1/4	0.718	0.719	2.09	1.61	•	•	•
16 FTX	0103-16-16	1	1 5/16-12	1-11 1/2	1 3/8	0.844	0.938	2.30	1.73	•	•	•
16-8 FTX	0103-8-16	1	1 5/16-12	1/2-14	1 3/8	0.844	0.531	2.11	1.65	•	•	•
16-12 FTX	0103-12-16	1	1 5/16-12	3/4-14	1 3/8	0.844	0.719	2.11	1.63	•	•	•
16-20 FTX	0103-20-16	1	1 5/16-12	1 1/4-11 1/2	1 11/16	0.844	1.250	2.41	1.82	•	•	•
16-24 FTX	0103-24-16	1	1 5/16-12	1 1/2-11 1/2	2	0.844	1.500	2.50	1.91	•	•	•
20 FTX	0103-20-20	1 1/4	1 5/8-12	1 1/4-11 1/2	1 11/16	1.078	1.250	2.45	1.86	•	•	•
20-16 FTX	0103-16-20	1 1/4	1 5/8-12	1-11 1/2	1 11/16	1.078	0.938	2.42	1.85	•	•	•
20-24 FTX	0103-24-20	1 1/4	1 5/8-12	1 1/2-11 1/2	2	1.078	1.500	2.55	1.96	•	•	•
24 FTX	0103-24-24	1 1/2	1 7/8-12	1 1/2-11 1/2	2	1.312	1.500	2.67	2.08	•	•	•
24-16 FTX	0103-16-24	1 1/2	1 7/8-12	1-11 1/2	2	1.312	0.938	2.62	2.05	•	•	•
24-20 FTX	0103-20-24	1 1/2	1 7/8-12	1 1/4-11 1/2	2	1.312	1.250	2.66	2.07	•	•	•
24-32 FTX	0103-32-24	1 1/2	1 7/8-12	2-11 1/2	2 5/8	1.312	1.312	2.86	2.25	•	•	•
32 FTX	0103-32-32	2	2 1/2-12	2-11 1/2	2 5/8	1.781	1.938	3.11	2.50	•	•	•
32-24 FTX	0103-24-32	2	2 1/2-12	1 1/2-11 1/2	2 5/8	1.781	1.500	3.08	2.49	•	•	•
40 FTX	0103-40-40	2 1/2	3-12	2 1/2-8	3 1/4	2.281	2.313	3.38	2.46	•	•	•

*Please see page C6 for conformance to military specifications.

Long Male Connector FFTX

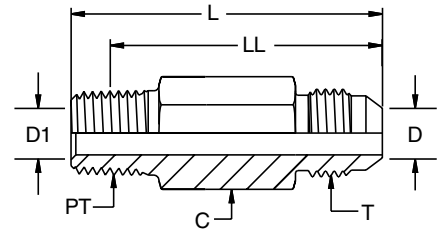

Flare tube end / male pipe end

SAE 071802

Part Number Information

FFTX - Body only

FFBTX - Body with tube nuts and sleeves

All dimensions are in inches

TUBE FITTING PART #	TUBE O.D. (inch)	T TUBE END UN/UNF-2A	PT PORT THD NPTF	C (inch)	D DRILL (inch)	D1 DRILL (inch)	L (inch)	LL AFTER ASSY (inch)	STANDARD MATERIAL FROM STOCK		
									S	SS	B
4 FFTX	1/4	7/16-20	1/8-27	1/2	0.172	0.172	1.81	1.58	•	•	
4-4 FFTX	1/4	7/16-20	1/4-18	9/16	0.172	0.172	2.25	1.91	•	•	
6 FFTX	3/8	9/16-20	1/4-18	5/8	0.297	0.281	2.25	1.91	•	•	
6-6 FFTX	3/8	9/16-20	3/8-18	3/4	0.297	0.297	2.50	2.15	•	•	
8 FFTX	1/2	3/4-16	3/8-18	13/16	0.391	0.406	2.75	2.40	•		
8-8 FFTX	1/2	3/4-16	1/2-14	15/16	0.531	0.391	2.80	2.34	•		
10 FFTX	5/8	7/8-14	1/2-14	15/16	0.484	0.531	3.12	2.66	•		
12 FFTX	3/4	1 1/16-12	3/4-14	1 1/8	0.609	0.609	3.50	3.02	•	•	

Male Run Tee RTX

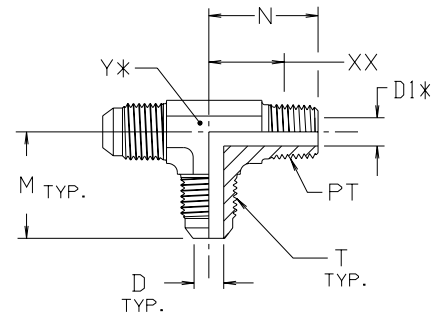

Flare tube ends / male pipe end

SAE 070424 MS515XX*

Part Number Information

RTX - Body only

RBTX - Body with tube nuts and sleeves

All dimensions are in inches

*Y — ACROSS WRENCH FLATS

D1* DRILL MAY BE PRESENT DUE TO MANUFACTURING OPTION PER SAE J514

TUBE FITTING PART #	HOSE FITTING PART #	TUBE O.D. (inch)	T TUBE END UN/UNF-2A	PT PORT THD NPTF	D DRILL (inch)	D1 DRILL (inch)	M (inch)	N (inch)	XX AFTER ASSY (inch)	Y (inch)	STANDARD MATERIAL FROM STOCK		
											S	SS	B
3 RTX	013T-2-3	3/16	3/8-24	1/8-27	0.125	0.188	0.83	0.72	0.48	7/16	•	•	
4 RTX	013T-2-4	1/4	7/16-20	1/8-27	0.172	0.188	0.89	0.78	0.54	7/16	•	•	•
4-4-4 RTX	013T-4-4-4	1/4	7/16-20	1/4-18	0.172	0.281	1.05	1.09	0.75	9/16	•	•	•
5 RTX	013T-2-5	5/16	1/2-20	1/8-27	0.234	0.188	0.97	0.81	0.57	9/16	•	•	•
5-4-5 RTX	013T-4-5-5	5/16	1/2-20	1/4-18	0.234	0.281	1.05	1.09	0.75	9/16	•	•	
6 RTX	013T-4-6	3/8	9/16-18	1/4-18	0.297	0.281	1.06	1.09	0.75	9/16	•	•	•
6-6-6 RTX	013T-6-6-6	3/8	9/16-18	3/8-18	0.297	0.406	1.14	1.22	0.87	3/4	•	•	
8 RTX	013T-6-8	1/2	3/4-16	3/8-18	0.391	0.406	1.25	1.22	0.87	3/4	•	•	•
8-8-8 RTX	013T-8-8-8	1/2	3/4-16	1/2-14	0.391	0.531	1.34	1.47	1.01	7/8	•	•	
10 RTX	013T-8-10	5/8	7/8-14	1/2-14	0.484	0.531	1.45	1.47	1.01	7/8	•	•	
12 RTX	013T-12-12	3/4	1 1/16-12	3/4-14	0.609	0.719	1.66	1.59	1.11	1 1/16	•	•	
12-8-12 RTX	013T-8-12-12	3/4	1 1/16-12	1/2-14	0.609	0.531	1.66	1.59	1.13	1 1/16	•	•	
14 RTX	013T-14-14	7/8	1 3/16-12	3/4-14	0.718	0.719	1.80	1.69	1.21	1 5/16	•		
16 RTX	013T-16-16	1	1 5/16-12	1-11 1/2	0.844	0.938	1.81	1.97	1.40	1 5/16	•	•	
20 RTX	013T-20-20	1 1/4	1 5/8-12	1 1/4-11 1/2	1.078	1.250	2.06	2.38	1.79	1 5/8	•	•	
24 RTX	013T-24-24	1 1/2	1 7/8-12	1 1/2-11 1/2	1.312	1.500	2.33	2.64	2.05	1 7/8	•	•	

*Please see page C6 for conformance to military specifications.



Male Branch Tee

STX

Flare tube ends / male pipe end

SAE 070425 MS515XX*

Part Number Information

STX - Body only

SBTX - Body with tube nuts and sleeves

All dimensions are in inches

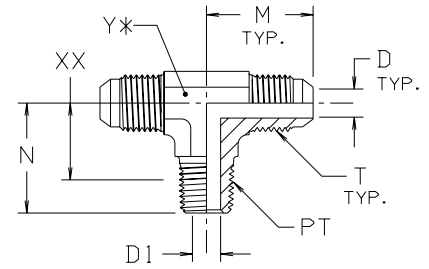

*Y — ACROSS WRENCH FLATS

TUBE FITTING PART #	HOSE FITTING PART #	TUBE O.D. (inch)	T TUBE END UN/UNF-2A	PT PORT THD NPTF	D DRILL (inch)	D1 DRILL (inch)	M (inch)	N (inch)	XX AFTER ASSY (inch)	Y (inch)	STANDARD MATERIAL FROM STOCK		
											S	SS	B
3 STX	213T-2-3	3/16	3/8-24	1/8-27	0.125	0.188	0.83	0.72	0.49	7/16	•	•	•
4 STX	213T-2-4	1/4	7/16-20	1/8-27	0.172	0.188	0.89	0.78	0.55	7/16	•	•	•
4-4-4 STX	213T-4-4-4	1/4	7/16-20	1/4-18	0.172	0.281	1.05	1.09	0.75	9/16	•	•	•
4-4-6 STX	213T-4-4-6	1/4	7/16-20	3/8-18	0.172	0.406	1.13	1.22	0.87	3/4	•	•	•
5 STX	213T-2-5	5/16	1/2-20	1/8-27	0.234	0.188	0.95	0.78	0.55	9/16	•	•	•
5-5-4 STX	213T-5-5-4	5/16	1/2-20	1/4-18	0.234	0.281	1.05	1.09	0.75	9/16	•	•	•
6 STX	213T-4-6	3/8	9/16-18	1/4-18	0.297	0.281	1.06	1.09	0.75	9/16	•	•	•
6-6-6 STX	213T-6-6-6	3/8	9/16-18	3/8-18	0.297	0.406	1.14	1.22	0.87	3/4	•	•	•
8 STX	213T-6-8	1/2	3/4-16	3/8-18	0.391	0.406	1.25	1.22	0.87	3/4	•	•	•
8-8-8 STX	213T-8-8-8	1/2	3/4-16	1/2-14	0.391	0.531	1.34	1.47	1.01	7/8	•	•	•
10 STX	213T-8-10	5/8	7/8-14	1/2-14	0.484	0.531	1.45	1.47	1.01	7/8	•	•	•
12 STX	213T-12-12	3/4	1 1/16-12	3/4-14	0.609	0.719	1.66	1.59	1.11	1 1/16	•	•	•
14 STX	213T-12-14	7/8	1 3/16-12	3/4-14	0.718	0.719	1.80	1.69	1.21	1 5/16	•	•	•
16 STX	213T-16-16	1	1 5/16-12	1-11 1/2	0.844	0.938	1.81	1.97	1.40	1 5/16	•	•	•
20 STX	213T-20-20	1 1/4	1 5/8-12	1 1/4-11 1/2	1.078	1.250	2.06	2.38	1.79	1 5/8	•	•	•
24 STX	213T-24-24	1 1/2	1 7/8-12	1 1/2-11 1/2	1.312	1.500	1.33	2.64	2.05	1 7/8	•	•	•

*Please see page C6 for conformance to military specifications.

45° Male Elbow

VTX

Flare tube end / male pipe end

SAE 070302 MS515XX*

Part Number Information

VTX - Body only

VBTX - Body with tube nut and sleeve

All dimensions are in inches

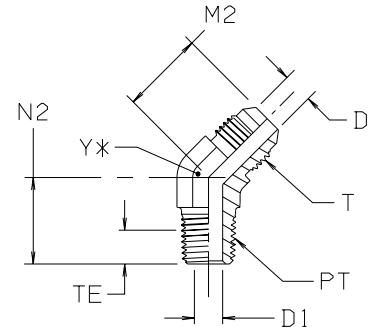

*Y — ACROSS WRENCH FLATS

TUBE FITTING PART #	HOSE FITTING PART #	TUBE O.D. (inch)	T TUBE END UN/UNF-2A	PT PORT THD NPTF	D DRILL (inch)	D1 DRILL (inch)	M2 (inch)	N2 (inch)	TE (inch)	Y (inch)	STANDARD MATERIAL FROM STOCK		
											S	SS	B
2 VTX	3103-2-2	1/8	5/16-24	1/8-27	0.062	0.188	0.69	0.53	0.24	7/16	•		
3 VTX	3103-2-3	3/16	3/8-24	1/8-27	0.125	0.188	0.69	0.53	0.24	7/16	•		
4 VTX	3103-2-4	1/4	7/16-20	1/8-27	0.172	0.188	0.72	0.64	0.24	7/16	•	•	•
4-4 VTX	3103-4-4	1/4	7/16-20	1/4-18	0.172	0.281	0.82	0.86	0.34	9/16	•	•	•
4-6 VTX	3103-6-4	1/4	7/16-20	3/8-18	0.172	0.406	0.92	0.95	0.46	3/4	•		
5 VTX	3103-2-5	5/16	1/2-20	1/8-27	0.234	0.188	0.77	0.64	0.24	9/16	•	•	•
5-4 VTX	3103-4-5	5/16	1/2-20	1/4-18	0.234	0.281	0.82	0.86	0.34	9/16	•	•	
6 VTX	3103-4-6	3/8	9/16-18	1/4-18	0.297	0.281	0.83	0.86	0.34	9/16	•	•	•
6-2 VTX	3103-2-6	3/8	9/16-18	1/8-27	0.297	0.188	0.83	0.67	0.24	9/16	•	•	•
6-6 VTX	3103-6-6	3/8	9/16-18	3/8-18	0.297	0.406	0.87	0.95	0.35	3/4	•	•	•
6-8 VTX	3103-8-6	3/8	9/16-18	1/2-14	0.297	0.531	1.06	1.17	0.46	7/8	•	•	
8 VTX	3103-6-8	1/2	3/4-16	3/8-18	0.391	0.406	0.98	0.95	0.35	3/4	•	•	•
8-4 VTX	3103-4-8	1/2	3/4-16	1/4-18	0.391	0.281	0.98	0.95	0.34	3/4	•	•	
8-8 VTX	3103-8-8	1/2	3/4-16	1/2-14	0.391	0.531	0.99	1.17	0.46	7/8	•	•	•
8-12 VTX	3103-12-8	1/2	3/4-16	3/4-14	0.391	0.719	1.04	1.20	0.48	1 1/16	•	•	
10 VTX	3103-8-10	5/8	7/8-14	1/2-14	0.484	0.531	1.11	1.17	0.46	7/8	•	•	•
10-6 VTX	3103-6-10	5/8	7/8-14	3/8-18	0.484	0.406	1.11	0.98	0.35	7/8	•	•	
10-12 VTX	3103-12-10	5/8	7/8-14	3/4-14	0.484	0.719	1.28	1.20	0.48	1 1/16	•		
12 VTX	3103-12-12	3/4	1 1/16-12	3/4-14	0.609	0.719	1.28	1.20	0.48	1 1/16	•	•	•
12-8 VTX	3103-8-12	3/4	1 1/16-12	1/2-14	0.609	0.531	1.28	1.20	0.46	1 1/16	•	•	
12-16 VTX	3103-16-12	3/4	1 1/16-12	1-11 1/2	0.609	0.938	1.42	1.48	0.57	1 5/16	•		
14 VTX	3103-12-14	7/8	1 3/16-12	3/4-14	0.718	0.719	1.39	1.27	0.48	1 5/16	•		
16 VTX	3103-16-16	1	1 5/16-12	1-11 1/2	0.844	0.938	1.47	1.48	0.57	1 5/16	•	•	•
16-12 VTX	3103-12-16	1	1 5/16-12	3/4-14	0.844	0.719	1.47	1.29	0.48	1 5/16	•	•	
16-20 VTX	3103-20-16	1	1 5/16-12	1 1/4-11 1/2	0.844	1.250	1.59	1.67	0.59	1 5/8	•		
20 VTX	3103-20-20	1 1/4	1 5/8-12	1 1/4-11 1/2	1.078	1.250	1.59	1.67	0.59	1 5/8	•	•	
20-16 VTX	3103-16-20	1 1/4	1 5/8-12	1-11 1/2	1.078	0.938	1.59	1.63	0.57	1 5/8	•		
24 VTX	3103-24-24	1 1/2	1 7/8-12	1 1/2-11 1/2	1.312	1.500	1.78	1.77	0.59	1 7/8	•	•	
32 VTX	3103-32-32	2	2 1/2-12	2-11 1/2	1.781	1.938	2.22	2.11	0.61	2 1/2	•		

*Please see page C6 for conformance to military specifications.

Male Bulkhead Connector WFTX

Flare tube end / male pipe end

Part Number Information
WFTX - Body only
WFBTX - Body with locknut, tube nut and sleeve
WFTX-WLN - Body with locknut

All dimensions are in inches

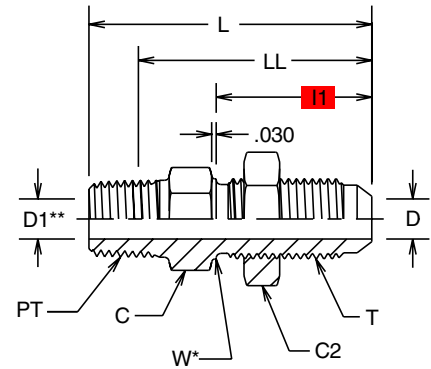

W* — BULKHEAD PILOT DIAMETER RECOMMENDED
CLEARANCE HOLE IS +0.015 OVER W DIAMETER
D1** MAY EXIST DUE TO MANUFACTURING OPTION

TUBE FITTING PART #	HOSE FITTING PART #	T TUBE END UN/UNF-2A	PT PORT THD NPTF	C HEX (inch)	C2 HEX (inch)	D DRILL (inch)	D1 DRILL (inch)	I1 (inch)	L (inch)	LL AFTER ASSY (inch)	W DIA (inch)	MAX BULKHEAD WALL THICKNESS (inch)	STANDARD MATERIAL FROM STOCK		
													S	SS	B
4 WFTX	0153-2-4N	7/16-20	1/8-27	11/16	11/16	0.172	0.172	1.2	1.88	1.65	0.44	0.33	•	•	
4-4 WFTX	0153-4-4N	7/16-20	1/4-18	1/2	11/16	0.172	0.281	1.20	2.07	1.84	0.44	0.33	•	•	
6 WFTX	0153-4-6N	9/16-18	1/4-18	13/16	13/16	0.297	0.281	1.28	2.15	1.81	0.56	0.42	•	•	
6-6 WFTX	0153-6-6N	9/16-18	3/8-18	3/4	13/16	0.297	0.406	1.28	2.16	1.78	0.56	0.42	•	•	
6-8 WFTX	0153-8-6N	9/16-18	1/2-14	7/8	13/16	0.297	0.531	1.28	2.41	1.95	0.56	0.42	•	•	
8 WFTX	0153-6-8N	3/4-16	3/8-18	1	1	0.391	0.406	1.44	2.31	1.96	0.75	0.44	•	•	
8-8 WFTX	0153-8-8N	3/4-16	1/2-14	1	1	0.391	0.531	1.44	2.56	2.10	0.75	0.44	•	•	
10 WFTX	0153-8-10N	7/8-14	1/2-14	1 1/8	1 1/8	0.484	0.531	1.58	2.71	2.25	0.88	0.43	•	•	
12 WFTX	0153-12-12N	1 1/16-12	3/4-14	1 1/8	1 3/8	0.609	0.719	1.75	2.95	2.47	1.06	0.44	•	•	
16 WFTX	0153-16-16N	1 5/16-12	1-11 1/2	1 5/8	1 5/8	0.844	0.938	1.75	3.14	2.57	1.31	0.39	•	•	

Swivel Connector F6X

Swivel nut end / male pipe end

Part Number Information
F6X - Body only

All dimensions are in inches

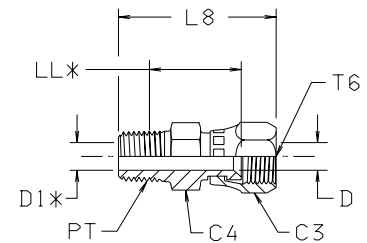

LL* — PORT FACE TO BASE OF FLARE SEAT
D1* DRILL MAY BE PRESENT DUE TO MANUFACTURING OPTION PER SAE J514

TUBE FITTING PART #	HOSE FITTING PART #	TUBE O.D. (inch)	T6 SWIVEL UN/UNF-2B	PT PORT THD NPTF	C3 (inch)	C4 (inch)	D DRILL (inch)	D1 DRILL (inch)	L8 (inch)	LL (inch)	STANDARD MATERIAL FROM STOCK		
											S	SS	B
4 F6X	0106-2-4	1/4	7/16-20	1/8-27	9/16	9/16	0.172	0.172	1.13	0.63	•	•	
4-4 F6X	0106-4-4	1/4	7/16-20	1/4-18	9/16	9/16	0.172	0.172	1.46	0.85	•	•	
5-4 F6X	0106-4-5	5/16	1/2-20	1/4-18	5/8	5/8	0.234	0.281	1.57	0.88	•	•	
6 F6X	0106-4-6	3/8	9/16-18	1/4-18	11/16	11/16	0.297	0.297	1.59	0.94	•	•	
6-6 F6X	0106-6-6	3/8	9/16-18	3/8-18	11/16	3/4	0.281	0.281	1.59	0.95	•	•	
8 F6X	0106-6-8	1/2	3/4-16	3/8-18	7/8	7/8	0.391	0.391	1.69	0.95	•	•	
8-8 F6X	0106-8-8	1/2	3/4-16	1/2-14	7/8	7/8	0.391	0.391	1.92	1.07	•	•	
10 F6X	0106-8-10	5/8	7/8-14	1/2-14	1	1	0.484	0.484	2.05	1.07	•	•	
10-6 F6X	0106-6-10	5/8	7/8-14	3/8-18	1	1	0.484	0.406	1.87	0.99	•	•	
12 F6X	0106-12-12	3/4	1 1/16-12	3/4-14	1 1/4	1 1/4	0.609	0.609	2.15	1.15	•	•	
12-8 F6X	0106-8-12	3/4	1 1/16-12	1/2-14	1 1/4	1 1/4	0.594	0.531	2.15	1.17	•	•	
16 F6X	0106-16-16	1	1 5/16-12	1-11 1/2	1 1/2	1 1/2	0.844	0.844	2.50	1.90	•	•	
16-12 F6X	0106-12-16	1	1 5/16-12	3/4-14	1 1/2	1 1/2	0.844	0.719	2.33	1.21	•	•	
20 F6X	0106-20-20	1 1/4	1 5/8-12	1 1/4-11 1/2	2	2	1.078	1.078	2.76	1.47	•	•	
24 F6X	0106-24-24	1 1/2	1 7/8-12	1 1/2-11 1/2	2 1/4	2 1/4	1.312	1.312	3.05	1.71	•	•	
32 F6X	0106-32-32	2	2 1/2-12	2-11 1/2	2 7/8	2 5/8	1.781	1.781	3.38	1.98	•	•	

Female Pipe Swivel Connector G6X

Swivel Nut end / Female pipe end

Part Number Information
G6X - Body only

All dimensions are in inches

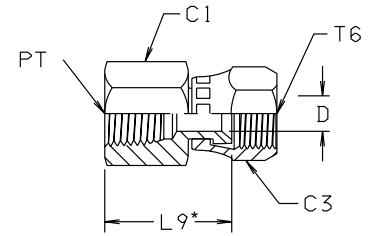

*L9 - PORT FACE TO BASE OF FLARE SEAT



TUBE FITTING PART #	HOSE FITTING PART #	TUBE O.D. (inch)	T6 SWIVEL UN/UNF-2B	PT PORT THD NPTF	C1 (inch)	C3 HEX (inch)	D (inch)	L9 (inch)	STANDARD MATERIAL FROM STOCK		
									S	SS	B
4 G6X	0206-2-4	1/4	7/16-20	1/8-27	9/16	9/16	0.172	0.92	•	•	
4-4 G6X	0206-4-4	1/4	7/16-20	1/4-18	3/4	9/16	0.172	1.08	•	•	
6 G6X	0206-4-6	3/8	9/16-18	1/4-18	3/4	11/16	0.297	1.06	•	•	
6-6 G6X	0206-6-6	3/8	9/16-18	3/8-18	7/8	11/16	0.267	1.16	•	•	
6-8 G6X	0206-8-6	3/8	9/16-18	1/2-14	1 1/8	11/16	0.297	1.42	•	•	
8 G6X	0206-6-8	1/2	3/4-16	3/8-18	7/8	7/8	0.391	1.23	•	•	
8-8 G6X	0206-8-8	1/2	3/4-16	1/2-14	1 1/8	7/8	0.391	1.48	•	•	
10 G6X	0206-8-10	5/8	7/8-14	1/2-14	1 1/8	1	0.484	1.47	•	•	
12 G6X	0206-12-12	3/4	1 1/16-12	3/4-14	1 3/8	1 1/4	0.609	1.51	•	•	
12-8 G6X	0206-8-12	3/4	1 1/16-12	1/2-14	1 1/4	1 1/4	0.609	1.50	•	•	
16 G6X	0206-16-16	1	1 5/16-12	1-11 1/2	1 5/8	1 1/2	0.844	1.85	•	•	
20 G6X	0206-20-20	1 1/4	1 5/8-12	1 1/4-11 1/2	2	2	1.078	2.17	•	•	
24 G6X	0206-24-24	1 1/2	1 7/8-12	1 1/2-11 1/2	2 3/8	2 1/4	1.312	2.26	•	•	
32 G6X	0206-32-32	2	2 1/2-12	2-11 1/2	2 7/8	2 7/8	1.781	2.45	•	•	

Swivel Nut Union HX6

Swivel nut end / swivel nut end

Part Number Information
HX6 - Body only

All dimensions are in inches

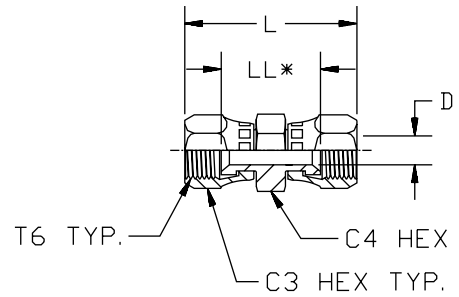

LL* — BASE OF FLARE SEAT
TO BASE OF FLARE SEAT

TUBE FITTING PART #	TUBE O.D. (inch)	T6 SWIVEL UN/UNF-2B	C3 HEX (inch)	C4 HEX (inch)	D DRILL (inch)	L (inch)	LL (inch)	STANDARD MATERIAL FROM STOCK		
								S	SS	B
4 HX6	1/4	7/16-20	9/16	9/16	0.172	1.48	0.80	•		
6 HX6	3/8	9/16-18	11/16	11/16	0.297	1.75	1.01	•		
8 HX6	1/2	3/4-16	7/8	7/8	0.391	2.02	1.16	•		
10 HX6	5/8	7/8-14	1	1	0.484	2.24	1.26	•		
12 HX6	3/4	1 1/16-12	1 1/4	1 1/4	0.609	2.43	1.31	•		
16 HX6	1	1 5/16-12	1 1/2	1 1/2	0.844	2.68	1.50	•		

Swivel Nut Union Tee JX6

Swivel nut end (all three ends)

Part Number Information
JX6 - Body only

All dimensions are in inches

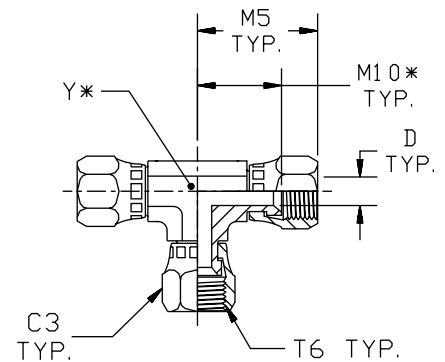

Y* — ACROSS WRENCH FLATS
M10* — CENTER TO BASE OF FLARE SEAT

TUBE FITTING PART #	TUBE O.D. (inch)	T6 SWIVEL UN/UNF-2B	C3 HEX (inch)	D DRILL (inch)	M5 (inch)	M10 (inch)	Y (inch)	STANDARD MATERIAL FROM STOCK		
								S	SS	B
4 JX6	1/4	7/16-20	9/16	0.172	1.00	0.66	7/16	•		
6 JX6	3/8	9/16-18	11/16	0.297	1.25	0.88	9/16	•		
8 JX6	1/2	3/4-16	7/8	0.391	1.38	0.95	3/4	•		
10 JX6	5/8	7/8-14	1	0.484	1.62	1.13	3/4	•		
12 JX6	3/4	1 1/16-12	1 1/4	0.609	1.75	1.19	1 1/16	•		
16 JX6	1	1 5/16-12	1 1/2	0.844	2.00	1.41	1 3/16	•		

Swivel Elbow Connector X6EF

Swivel nut end / male pipe end

Part Number Information
X6EF - Body only

All dimensions are in inches

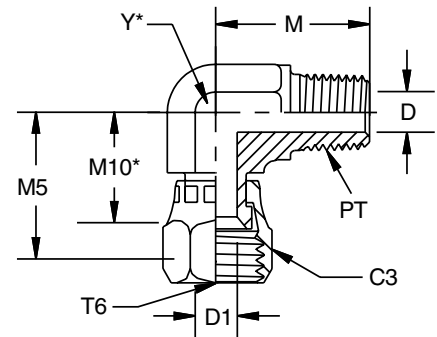

M10* — CENTER TO BASE OF FLARE SEAT

TUBE FITTING PART #	TUBE O.D. (inch)	PT PORT THD NPTF	T6 UN/UNF-2B	C3 HEX (inch)	D DRILL (inch)	D1 DRILL (inch)	M (inch)	M5 (inch)	M10 (inch)	Y (inch)	STANDARD MATERIAL FROM STOCK		
											S	SS	B
4 X6EF	1/4	1/8-27	7/16-20	9/16	0.188	0.172	0.78	1.01	0.66	7/16	•	•	
4-4 X6EF	1/4	1/4-18	7/16-20	9/16	0.281	0.172	1.09	1.13	0.78	9/16	•	•	
6 X6EF	3/8	1/4-18	9/16-18	11/16	0.281	0.297	1.09	1.27	0.88	9/16	•	•	
6-6 X6EF	3/8	3/8-18	9/16-18	11/16	0.406	0.297	1.22	1.27	0.88	3/4	•	•	
8 X6EF	1/2	3/8-18	3/4-16	7/8	0.406	0.391	1.22	1.34	0.95	3/4	•	•	
8-8 X6EF	1/2	1/2-14	3/4-16	7/8	0.531	0.391	1.47	1.48	1.09	7/8	•	•	
10 X6EF	5/8	1/2-14	7/8-14	1	0.718	0.484	1.47	1.62	1.11	7/8	•	•	
12 X6EF	3/4	3/4-14	1 1/16-12	1 1/4	0.719	0.609	1.59	1.75	1.18	1 1/16	•	•	
16 X6EF	1	1-11	1 5/16-12	1 1/2	0.938	0.844	1.97	2.01	1.41	1 5/16	•	•	

Swivel Straight Thread Connector F65OX / F65OMX

Swivel nut end / straight thread O-ring

Part Number Information
F65X - Body only
F65OX or F65OMX - Body with O-ring

All dimensions are in inches, except as noted

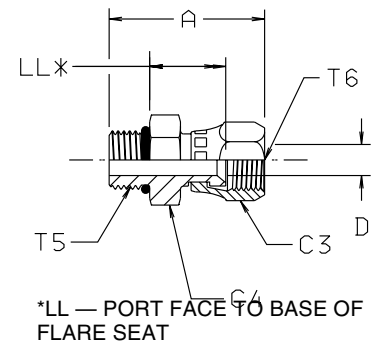

*LL — PORT FACE TO BASE OF FLARE SEAT

TUBE FITTING PART #	HOSE FITTING PART #	TUBE O.D. (inch)	T5 TUBE END UN/UNF-2A	T6 SWIVEL UN/UNF-2B	A (inch)	C3 HEX (inch)	C4 HEX (inch)	D DRILL (inch)	LL (inch)	STANDARD MATERIAL FROM STOCK		
										S	SS	B
*4F65OMX	0506-4-4	1/4	7/16-20	7/16-20	1.31	16 mm	14 mm	0.172	0.56	•	•	
4 F65OX	0506-4-4	1/4	7/16-20	7/16-20	1.31	9/16	9/16	0.172	0.56	•	•	
*5F65OMX	0506-6-6	5/16	1/2-20	1/2-20	1.35	16 mm	17 mm	0.234	0.61	•	•	
6 F65OX	0506-6-6	3/8	9/16-18	9/16-18	1.43	11/16	11/16	0.297	0.61	•	•	
6-8 F65OX	0506-8-6	3/8	3/4-16	9/16-18	1.50	11/16	7/8	0.297	0.62	•	•	
8 F65OX	0506-8-8	1/2	3/4-16	3/4-16	1.61	7/8	7/8	0.391	0.62	•	•	
8-6 F65OX	0506-6-8	1/2	9/16-18	3/4-16	1.54	7/8	13/16	0.297	0.73	•	•	
10 F65OX	0506-10-10	5/8	7/8-14	7/8-14	1.84	1	1 1/16	0.484	0.72	•	•	
12 F65OX	0506-12-12	3/4	1 1/16-12	1 1/16-12	2.07	1 1/4	1 1/4	0.609	0.76	•	•	
*16F65OMX	0506-16-16	1	1 5/16-12	1 5/16-12	2.28	38mm	38mm	0.846	0.83	•	•	
16 F65OX	0506-16-16	1	1 5/16-12	1 5/16-12	2.28	1 1/2	1 1/2	0.846	0.83	•	•	
*20F65OMX	0506-20-20	1 1/4	1 5/8-12	1 5/8-12	2.49	50mm	50mm	1.078	1.01	•	•	
20 F65OX	0506-20-20	1 1/4	1 5/8-12	1 5/8-12	2.49	2	2	1.078	1.01	•	•	

*Use compressed nomenclature for metric hex parts.
Example: 4F65OMX

Nut BTX

Flare tube end nut

SAE 070110 MS515XX*

Part Number Information
BTX - Nut

All dimensions are in inches
except as noted

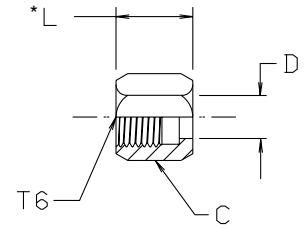

TUBE FITTING PART #	HOSE FITTING PART #	TUBE O.D. (inch)	T6 UN/UNF-2B	C HEX (inch)	D (inch)	L (inch)	STANDARD MATERIAL FROM STOCK		
							S	SS	B
2 BTX	06B2	1/8	5/16-24	3/8	0.18	0.55	•	•	•
3 BTX	06B-3	3/16	3/8-24	7/16	0.24	0.61	•	•	•
4 BTX	06B-4	1/4	7/16-20	9/16	0.31	0.62	•	•	•
5 BTX	06B-5	5/16	1/2-20	5/8	0.38	0.68	•	•	•
6 BTX	06B-6	3/8	9/16-18	11/16	0.44	0.73	•	•	•
8 BTX	06B-8	1/2	3/4-16	7/8	0.57	0.85	•	•	•
10 BTX	06B-10	5/8	7/8-14	1	0.70	0.98	•	•	•
12 BTX	06B-12	3/4	1 1/16-12	1 1/4	0.84	1.03	•	•	•
14 BTX	06B-14	7/8	1 3/16-12	1 3/8	0.96	1.09	•	•	•
16 BTX	06B-16	1	1 5/16-12	1 1/2	1.09	1.13	•	•	•
20 BTX	06B-20	1 1/4	1 5/8-12	2	1.35	1.23	•	•	•
24 BTX	06B-24	1 1/2	1 7/8-12	2 1/4	1.62	1.42	•	•	•
32 BTX	06B-32	2	2 1/2-12	2 7/8	2.17	1.75	•	•	•

*Please see page C6 for conformance to military specifications.

Cap FNTX

Flare tube end cap

SAE 070112 MS515XX*

Part Number Information
FNTX - Cap

All dimensions are in inches

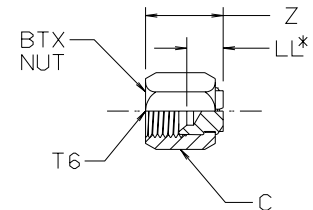

*LL — END TO BASE OF MATING FLARE-SEAT

TUBE FITTING PART #	HOSE FITTING PART #	TUBE O.D. (inch)	T6 UN/UNF-2B	C HEX (inch)	LL (inch)	Z (inch)	STANDARD MATERIAL FROM STOCK		
							S	SS	B
2 FNTX	06CP-2	1/8	5/16-24	3/8	0.38	0.60	•	•	•
3 FNTX	06CP-3	3/16	3/8-24	7/16	0.38	0.66	•	•	•
4 FNTX	06CP-4	1/4	7/16-20	9/16	0.34	0.67	•	•	•
5 FNTX	06CP-5	5/16	1/2-20	5/8	0.41	0.77	•	•	•
6 FNTX	06CP-6	3/8	9/16-18	11/16	0.47	0.81	•	•	•
8 FNTX	06CP-8	1/2	3/4-16	7/8	0.53	0.94	•	•	•
10 FNTX	06CP-10	5/8	7/8-14	1	0.53	1.07	•	•	•
12 FNTX	06CP-12	3/4	1 1/16-12	1 1/4	0.66	1.24	•	•	•
14 FNTX	06CP-14	7/8	1 3/16-12	1 3/8	0.63	1.26	•	•	•
16 FNTX	06CP-16	1	1 5/16-12	1 1/2	0.63	1.29	•	•	•
20 FNTX	06CP-20	1 1/4	1 5/8-12	2	0.75	1.39	•	•	•
24 FNTX	06CP-24	1 1/2	1 7/8-12	2 1/4	0.94	1.70	•	•	•
32 FNTX	06CP-32	2	2 1/2-12	2 7/8	1.10	2.01	•	•	•

*Please see page C6 for conformance to military specifications.

Plug PNTX

Flare tube / hose swivel plug

SAE 070109 MS515XX*

Part Number Information
PNTX - Plug

All dimensions are in inches

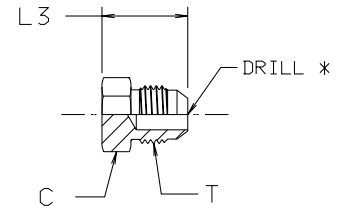

*DRILL MAY BE PRESENT DUE TO MANUFACTURING OPTION PER SAE J514



TUBE FITTING PART #	HOSE FITTING PART #	TUBE O.D. (inch)	T TUBE END UN/UNF-2A	C HEX (inch)	L3 (inch)	STANDARD MATERIAL FROM STOCK		
						S	SS	B
2 PNTX	03CP-2	1/8	5/16-24	7/16	0.70	•	•	
3 PNTX	03CP-3	3/16	3/8-24	7/16	0.73	•	•	
4 PNTX	03CP-4	1/4	7/16-20	1/2	0.80	•	•	•
5 PNTX	03CP-5	5/16	1/2-20	9/16	0.80	•	•	
6 PNTX	03CP-6	3/8	9/16-18	5/8	0.84	•	•	•
8 PNTX	03CP-8	1/2	3/4-16	13/16	0.94	•	•	•
10 PNTX	03CP-10	5/8	7/8-14	15/16	1.10	•	•	•
12 PNTX	03CP-12	3/4	1 1/16-12	1 1/8	1.28	•	•	•
14 PNTX	03CP-14	7/8	1 3/16-12	1 1/4	1.31	•	•	
16 PNTX	03CP-16	1	1 5/16-12	1 3/8	1.33	•	•	
20 PNTX	03CP-20	1 1/4	1 5/8-12	1 11/16	1.45	•	•	
24 PNTX	03CP-24	1 1/2	1 7/8-12	2	1.66	•	•	
32 PNTX	03CP-32	2	2 1/2-12	2 5/8	2.05	•	•	

*Please see page C6 for conformance to military specifications.

Mountie T22X

Used with BTX nut to plug one port on Triple-Lok tee or cross for self-mounting

Part Number Information
T22X - Mountie

All dimensions are in inches

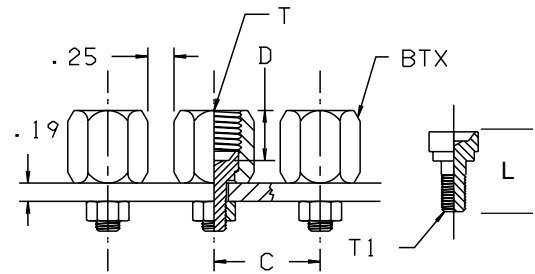

TUBE FITTING PART #	TUBE O.D. (inch)	T UN/UNF-2B	T1 UNC/UNF-2A	C (inch)	D (inch)	L (inch)	STANDARD MATERIAL FROM STOCK		
							S	SS	B
4 T22X	1/4	7/16-20	1/4-20	0.91	0.52	0.72	•		
6 T22X	3/8	9/16-18	1/4-20	1.08	0.51	0.81	•		
8 T22X	1/2	3/4-16	5/16-18	1.25	0.60	0.97	•		

Tube Extender / Orifice Connector

XHX7

Female to Male Flare tube end

Part Number Information

XHX7 - Body

Orifice Connector - [Contact your local Parker distributor or the Tube Fittings Division](#)

All dimensions are in inches

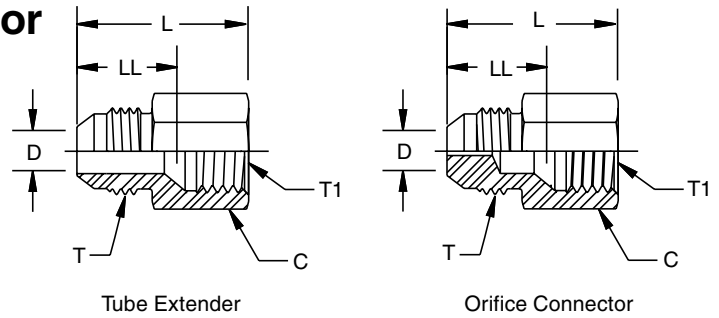

TUBE FITTING PART #	TUBE O.D. (inch)	T TUBE END UN/UNF-2A	T1 TUBE END UN/UNF-2B	C (inch)	D DRILL (inch)	L (inch)	LL (inch)	STANDARD MATERIAL FROM STOCK		
								S	SS	B
4 XHX7	1/4	7/16-20	7/16-20	9/16	0.172	1.14	0.46	•		
6 XHX7	3/8	9/16-18	9/16-18	11/16	0.297	1.18	0.47	•		
8 XHX7	1/2	3/4-16	3/4-16	7/8	0.391	1.32	0.56	•		

Tube End Reducer

TRTX

Assembles to Triple-Lok end to reduce size

SAE 070123 MS515XX*

Part Number Information
See Table below

All dimensions are in inches

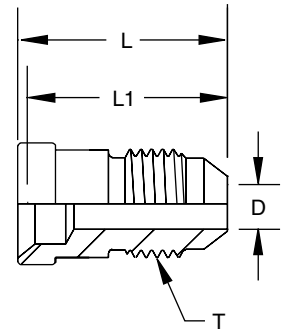

TUBE FITTING PART #							STANDARD MATERIAL FROM STOCK		
TRTX	TRBTX	TUBE O.D.	T	D	L	L1	S	SS	B
BODY ONLY	BODY WITH REDUCED NUT AND SLEEVE	REDUCTION	TUBE END UN/UNF-2A	DRILL					
4-2 TRTX	4-2 TRBTX	1/4 to 1/8	5/16-24	0.062	0.75	0.75		•	
6-4 TRTX	6-4 TRBTX	3/8 to 1/4	7/16-20	0.172	0.97	0.97	•	•	•
8-4 TRTX	8-4 TRBTX	1/2 to 1/4	7/16-20	0.172	1.00	1.00	•	•	•
8-6 TRTX	8-6 TRBTX	1/2 to 3/8	9/16-18	0.297	1.00	1.00	•	•	•
10-4 TRTX	10-4 TRBTX	5/8 to 1/4	7/16-20	0.172	1.03	1.03	•	•	•
10-6 TRTX	10-6 TRBTX	5/8 to 3/8	9/16-18	0.297	1.03	1.03	•	•	•
12-4 TRTX	12-4 TRBTX	3/4 to 1/4	7/16-20	0.172	1.09	1.09	•	•	•
12-6 TRTX	12-6 TRBTX	3/4 to 3/8	9/16-18	0.297	1.09	1.09	•	•	•
12-8 TRTX	12-8 TRBTX	3/4 to 1/2	3/4-16	0.391	1.19	1.19	•	•	•
14-6 TRTX	14-6 TRBTX	7/8 to 3/8	9/16-18	0.297	1.13	1.13	•		
14-10 TRTX	14-10 TRBTX	7/8 to 5/8	7/8-14	0.484	1.33	1.33	•		
16-4 TRTX	16-4 TRBTX	1 to 1/4	7/16-20	0.172	1.22	1.22		•	
16-6 TRTX	16-6 TRBTX	1 to 3/8	9/16-18	0.297	1.22	1.22		•	
16-8 TRTX	16-8 TRBTX	1 to 1/2	3/4-16	0.391	1.27	1.26	•	•	
16-10 TRTX	16-10 TRBTX	1 to 5/8	41828	0.484	1.38	1.38	•		
16-12 TRTX	16-12 TRBTX	1 to 3/4	1 1/16-12	0.609	1.47	1.47	•	•	
20-12 TRTX	20-12 TRBTX	1 1/4 to 3/4	1 1/16-12	0.609	1.53	1.53	•	•	
20-16 TRTX	20-16 TRBTX	1 1/4 to 1	1 5/16-12	0.844	1.59	1.59	•	•	
24-8 TRTX	24-8 TRBTX	1 1/2 to 1/2	3/4-16	0.391	1.41	1.56		•	
24-12 TRTX	24-12 TRBTX	1 1/2 to 3/4	1 1/16-12	0.609	1.63	1.63		•	
24-16 TRTX	24-16 TRBTX	1 1/2 to 1	1 5/16-12	0.844	1.63	1.63	•	•	
24-20 TRTX	24-20 TRBTX	1 1/2 to 1 1/4	1 5/8-12	1.078	1.69	1.69	•	•	
32-24 TRTX	32-24 TRBTX	2 to 1 1/2	1 7/8-12	1.312	1.91	1.91	•	•	

*Please see page C6 for conformance to military specifications.

Tube End Reducer TRTXN

Assembles to Triple-Lok end to reduce size

SAE 070123A MS515XX*

Part Number Information
See Table below

All dimensions are in inches

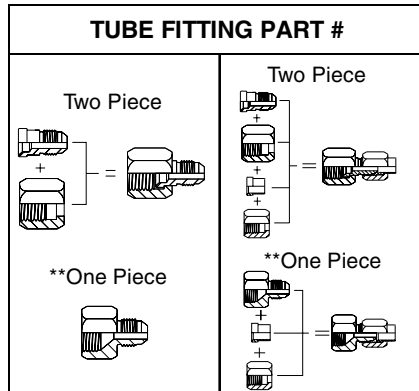
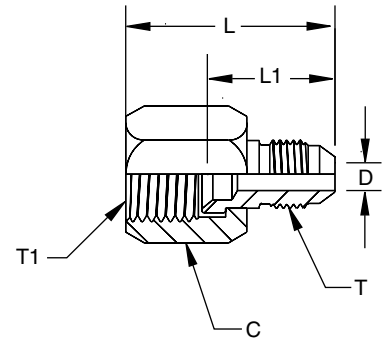

TRTXN	TRBTXN	HOSE FITTING PART # (SEE NOTE 1)	TUBE O.D. REDUCTION	T TUBE END UN/UNF-2A	T1 TUBE END UN/UNF-2B	C HEX	D DRILL	L	L1	STANDARD MATERIAL FROM STOCK		
										S	SS	B
4-2 TRTXN	4-2 TRBTXN	0603-4-2	1/4 to 1/8	5/16-24	7/16-20	9/16	0.062	1.23	0.75		•	
**4-3 TRTXN	**4-3 TRBTXN	0603-4-3	1/4 to 3/16	3/8-24	7/16-20	9/16	0.125	1.09	0.76		•	
6-4 TRTXN	6-4 TRBTXN	0603-6-4	3/8 to 1/4	7/16-20	9/16-18	11/16	0.172	1.53	0.97	•	•	•
8-4 TRTXN	8-4 TRBTXN	0603-8-4	1/2 to 1/4	7/16-20	3/4-16	7/8	0.172	1.63	1.00	•	•	•
8-6 TRTXN	8-6 TRBTXN	0603-8-6	1/2 to 3/8	9/16-18	3/4-16	7/8	0.297	1.63	1.00	•	•	•
10-4 TRTXN	10-4 TRBTXN	0603-10-4	5/8 to 1/4	7/16-20	7/8-14	1	0.172	1.78	1.03	•	•	
10-6 TRTXN	10-6 TRBTXN	0603-10-6	5/8 to 3/8	9/16-18	7/8-14	1	0.297	1.78	1.03	•	•	•
**10-8 TRTXN	**10-8 TRBTXN	0603-10-8	5/8 to 1/2	3/4-16	7/8-14	1	0.391	1.88	1.13	•	•	
12-4 TRTXN	12-4 TRBTXN	0603-12-4	3/4 to 1/4	7/16-20	1 1/16-12	1 1/4	0.172	1.85	1.09	•	•	•
12-6 TRTXN	12-6 TRBTXN	0603-12-6	3/4 to 3/8	9/16-18	1 1/16-12	1 1/4	0.297	1.85	1.09	•	•	•
12-8 TRTXN	12-8 TRBTXN	0603-12-8	3/4 to 1/2	3/4-16	1 1/16-12	1 1/4	0.391	1.95	1.19	•	•	•
**12-10 TRTXN	**12-10 TRBTXN	0603-12-10	3/4 to 5/8	7/8-14	1 1/16-12	1 1/4	0.484	2.05	1.29	•	•	
14-6 TRTXN	14-6 TRBTXN	0603-14-6	7/8 to 3/8	9/16-18	1 3/16-12	1 3/8	0.297	1.96	1.13	•		
14-10 TRTXN	14-10 TRBTXN	0603-14-10	7/8 to 5/8	7/8-14	1 3/16-12	1 3/8	0.484	2.16	1.33	•		
**14-12 TRTXN	**14-12 TRBTXN	0603-14-12	7/8 to 3/4	1 1/16-12	1 3/16-12	1 3/8	0.609	1.84	1.31	•		
16-4 TRTXN	16-4 TRBTXN	0603-16-4	1 to 1/4	7/16-20	1 5/16-12	1 1/2	0.172	2.07	1.22		•	
16-6 TRTXN	16-6 TRBTXN	0603-16-6	1 to 3/8	9/16-18	1 5/16-12	1 1/2	0.297	1.90	1.22		•	
16-8 TRTXN	16-8 TRBTXN	0603-16-8	1 to 1/2	3/4-16	1 5/16-12	1 1/2	0.391	2.11	1.26	•	•	
16-10 TRTXN	16-10 TRBTXN	0603-16-10	1 to 5/8	41828	1 5/16-12	1 1/2	0.484	2.06	1.38	•		
16-12 TRTXN	16-12 TRBTXN	0603-16-12	1 to 3/4	1 1/16-12	1 5/16-12	1 1/2	0.609	2.32	1.47	•	•	
**16-14 TRTXN	**16-14 TRBTXN	0603-16-14	1 to 7/8	1 3/16-12	1 5/16-12	1 1/2	0.718	2.35	1.50	•		
20-12 TRTXN	20-12 TRBTXN	0603-20-12	1 1/4 to 3/4	1 1/16-12	1 5/8-12	2	0.609	2.45	1.53	•	•	
20-16 TRTXN	20-16 TRBTXN	0603-20-16	1 1/4 to 1	1 5/16-12	1 5/8-12	2	0.844	2.51	1.59	•	•	
24-8 TRTXN	24-8 TRBTXN	0603-24-8	1 1/2 to 1/2	3/4-16	1 7/8-12	2 1/4	0.391	2.39	1.56		•	
24-12 TRTXN	24-12 TRBTXN	0603-24-12	1 1/2 to 3/4	1 1/16-12	1 7/8-12	2 1/4	0.609	2.46	1.63		•	
24-16 TRTXN	24-16 TRBTXN	0603-24-16	1 1/2 to 1	1 5/16-12	1 7/8-12	2 1/4	0.844	2.46	1.63	•	•	
24-20 TRTXN	24-20 TRBTXN	0603-24-20	1 1/2 to 1 1/4	1 5/8-12	1 7/8-12	2 1/4	1.078	2.77	1.69	•	•	
32-24 TRTXN	32-24 TRBTXN	0603-32-24	2 to 1 1/2	1 7/8-12	2 1/2-12	2 7/8	1.312	2.96	1.91	•	•	

Note 1: Hose Fitting part numbers apply to TRTXN level.

*Please see page C6 for conformance to military specifications.

Inch Sleeve TX

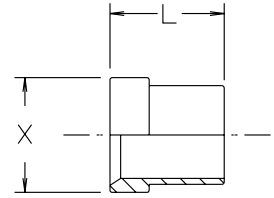

Flare tube end sleeve

SAE 070115 MS515XX*

Part Number Information
TX - Sleeve

All dimensions are in inches

TUBE FITTING PART #	HOSE FITTING PART #	TUBE O.D. (inch)	L (inch)	X (inch)	STANDARD MATERIAL FROM STOCK		
					S	SS	B
2 TX	06S-2	1/8	0.34	0.27	•	•	•
3 TX	06S-3	3/16	0.34	0.33	•	•	•
4 TX	06S-4	1/4	0.41	0.38	•	•	•
5 TX	06S-5	5/16	0.44	0.45	•	•	•
6 TX	06S-6	3/8	0.50	0.50	•	•	•
8 TX	06S-8	1/2	0.56	0.68	•	•	•
10 TX	06S-10	5/8	0.66	0.80	•	•	•
12 TX	06S-12	3/4	0.69	0.97	•	•	•
14 TX	06S-14	7/8	0.75	1.10	•	•	•
16 TX	06S-16	1	0.78	1.22	•	•	•
20 TX	06S-20	1 1/4	0.91	1.53	•	•	•
24 TX	06S-24	1 1/2	1.13	1.78	•	•	•
32 TX	06S-32	2	1.19	2.41	•	•	•

*Please see page C6 for conformance to military specifications.

Bulkhead Locknut WLN

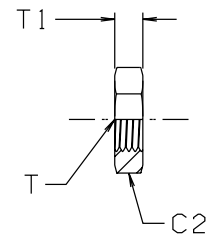

Bulkhead fitting locknut for Ferulok and Triple-Lok bulkhead fittings

SAE 080118 and 070118 MS518XX*

Part Number Information
WLN - Bulkhead locknut

All dimensions are in inches

TUBE FITTING PART #	HOSE FITTING PART #	TUBE O.D. (inch)	T UN/UNF-2B	C2 HEX (inch)	T1 (inch)	STANDARD MATERIAL FROM STOCK		
						S	SS	B
3 WLN	53-3N	3/16	3/8-24	5/8	0.22	•	•	•
4 WLN	53-4N	1/4	7/16-20	11/16	0.28	•	•	•
5 WLN	53-5N	5/16	1/2-20	3/4	0.28	•	•	•
6 WLN	53-6N	3/8	9/16-18	13/16	0.27	•	•	•
8 WLN	53-8N	1/2	3/4-16	1	0.31	•	•	•
10 WLN	53-10N	5/8	7/8-14	1 1/8	0.36	•	•	•
12 WLN	53-12N	3/4	1 1/16-12	1 3/8	0.41	•	•	•
14 WLN	53-14N	7/8	1 3/16-12	1 1/2	0.41	•	•	•
16 WLN	53-16N	1	1 5/16-12	1 5/8	0.41	•	•	•
20 WLN	53-20N	1 1/4	1 5/8-12	1 7/8	0.41	•	•	•
24 WLN	53-24N	1 1/2	1 7/8-12	2 1/8	0.41	•	•	•
32 WLN	53-32N	2	2 1/2-12	2 3/4	0.41	•	•	•

[Click Here to Go to the First Page of the Next Section](#)

*Please see page C6 for conformance to military specifications.