

Needle Valves

Pipe Valves

P Series

Pressures to 15,000 psi (1034 bar)

Since 1945 Parker Autoclave Engineers has designed and built premium quality valves, fittings and tubing. This commitment to engineering and manufacturing excellence has earned Parker Autoclave Engineers a reputation for reliable efficient product performance. Parker Autoclave Engineers has long been established as the world leader in high pressure fluid handling components for the chemical/petrochemical, research, and oil and gas industries.

Pipe Valve Features:

- P Series valve design provides in-line pipe connections for 1/4" to 1" pipe sizes. 1/8 connections offset.
- Rising stem/barstock body design.
- Non-rotating stem prevents stem/seat galling (1/8" NPT rotating stem design).
- Metal-to-metal seating achieves bubble-tight shut-off, longer stem/seat life in abrasive flow, greater durability for repeated on/off cycles and excellent corrosion resistance.
- PTFE encapsulated packing provides dependable stem and body sealing.
- Stem sleeve and packing gland materials have been selected to achieve extended thread cycle life and reduced handle torque.
- Choice of Vee or Regulating stem tips.
- Operating temperature range from -423°F (-252°C) to 400°F (204°C).

Parker Autoclave Engineers valves are complemented by a complete line of fittings, tubing, check valves and line filters.



Valve Series - P Series

Pressures to 15,000 psi (1034 bar)

Tube Outside Diameter Size Inches	Connection Type	Orifice Size Inches (mm)	Rated C_V *	Pressure Rating psi (bar) @ Room Temperature**
1/8	Pipe	0.078 (1.98)	0.11	15,000 (1034)
1/4	Pipe	0.203 (5.16)	0.63	15,000 (1034)
3/8	Pipe	0.219 (5.56)	0.75	15,000 (1034)
1/2	Pipe	0.312 (7.92)	1.30	15,000 (1034)
3/4	Pipe	0.438 (11.13)	2.50	10,000 (690)
1	Pipe	0.562 (14.27)	4.40	10,000 (690)

Notes:

* C_V values shown are for 2-way straight valve pattern. For 2-way angle patterns, increase C_V value 50%. (Based on water)

** For complete temperature ratings see pressure/temperature rating guide in Technical Information section.

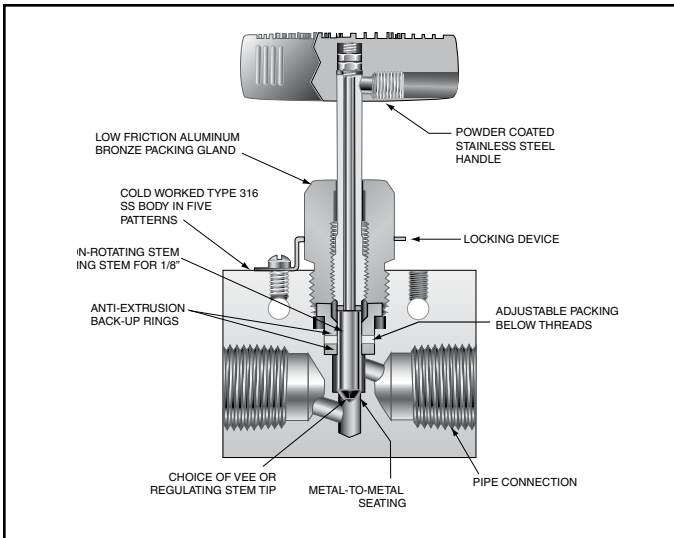

Generalized Flow Coefficient Curves (C_V)

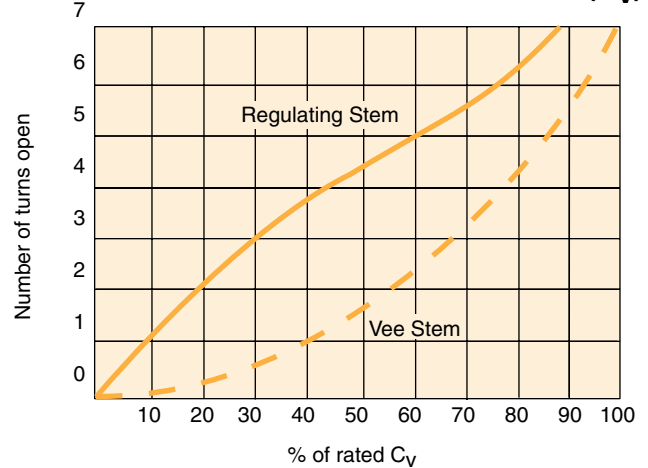

Ordering Procedure

For complete information on available stem types, optional connections and additional valve options, see Needle Valve Options section or contact your Sales Representative.

Typical catalog number: **15P4071**

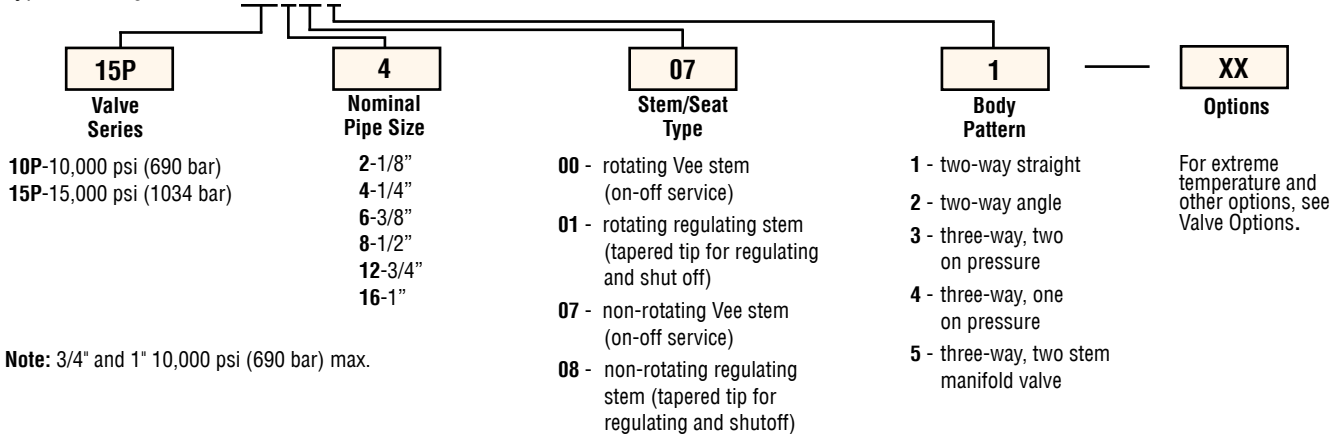

Valve Options

Extreme Temperatures

Standard Parker Autoclave Engineers valves with PTFE packing may be operated to 450°F (232°C). High temperature packing and/or extended stuffing box is available for service from 0°F (-17.8°C) to 650°F (343°C) by adding the following suffixes to catalog order number. †

TG standard valve with PTFE glass packing to 600°F (316°C).

GY standard valve with graphite braided yarn packing to 650°F (343°C).

B standard valve with cryogenic trim material and PTFE packing to -100°F (-73°C).

LT extended stuffing box valve with Teflon packing and cryogenic trim materials to -423°F (-252°C). †

† Parker Autoclave Engineers recommends pipe connections be operated between -423°F (-252°C) and 400°F (204°C). For additional valve options, contact your Sales Representative.

Valve Maintenance

Repair Kits: add "R" to the front of valve catalog number for proper repair kit.
(Example: **R15P4071** or **R10P12071**)

Valve Bodies: Valve bodies are available. Order using the eight (8) digit part number found on the valve drawing or contact your Sales Representative for information.

Consult your Parker Autoclave Engineers representative for pricing on repair kits and valve bodies. Refer to the Tools, Installation, Operation and Maintenance section for proper maintenance procedures.

Catalog Number	Stem Type	Pipe Size	Orifice Diameter	Dimensions - inches (mm)												Block Thickness	Valve Pattern
				A	B	C	D	D ₁	E	F	G	G ₁	H	M	N		

2-Way Straight

15P2001	VEE	1/8	0.078	1.50	0.75		0.56	0.82	1.25	1.75	0.56	0.16	2.53	0.45	0.20	0.63	See Figure 1
15P2011	REG	(3.18)	(1.98)	(38.10)	(19.05)		(14.22)	(20.62)	(31.75)	(44.45)	(14.22)	(4.06)	(64.26)	(11.43)	(5.16)	(15.88)	
15P4071	VEE	1/4	0.203	2.00	1.00		1.41		2.00	3.00	0.75	0.22	4.63	0.62	0.38	0.75	
15P4081	REG	(6.35)	(5.16)	(50.80)	(25.40)		(35.81)		(50.80)	(76.20)	(19.05)	(5.59)	(117.60)	(15.75)	(9.65)	(19.05)	
15P6071	VEE	3/8	0.219	2.50	1.25		1.41		2.00	3.00	0.75	0.22	4.63	0.62	0.38	1.00	
15P6081	REG	(9.53)	(5.56)	(63.50)	(31.75)		(35.81)		(50.80)	(76.20)	(19.05)	(5.59)	(117.60)	(15.75)	(9.65)	(25.4)	
15P8071	VEE	1/2	0.312	3.00	1.50		2.06		2.88	4.00	1.00	0.34	5.93	0.69	0.50	1.38	
15P8081	REG	(12.70)	(7.92)	(76.20)	(38.10)		(52.32)		(73.15)	(101.60)	(25.40)	(8.64)	(150.62)	(17.53)	(12.70)	(35.05)	
10P12071	VEE	3/4	0.437	3.50	1.75		2.63		3.75	10.25	1.12	0.44	7.00	0.88	0.63	1.75	
10P12081	REG	(19.05)	(11.10)	(88.90)	(44.45)		(66.80)		(95.25)	(260.35)	(28.45)	(11.18)	(177.80)	(22.35)	(16.00)	(44.45)	
10P16071	VEE	1	0.562	4.12	2.06		3.31		4.62	10.25	1.62	0.56	9.00	1.25	1.13	1.75	
10P16081	REG	(25.40)	(14.27)	(104.65)	(52.32)		(84.07)		(117.35)	(260.35)	(41.15)	(14.22)	(228.60)	(31.75)	(28.70)	(44.45)	

2-Way Angle

15P2002	VEE	1/8	0.078	1.50	0.75		0.56		1.38	1.75	0.56	0.16	2.66	0.45	0.20	0.63	See Figure 2
15P2012	REG	(3.18)	(1.98)	(38.10)	(19.05)		(14.22)		(34.93)	(44.45)	(14.22)	(4.06)	(67.56)	(11.43)	(5.16)	(15.88)	
15P4072	VEE	1/4	0.203	2.00	1.00		1.41		2.44	3.00	0.75	0.22	4.81	0.62	0.38	0.75	
15P4082	REG	(6.35)	(5.16)	(50.80)	(25.40)		(35.81)		(61.98)	(76.20)	(19.05)	(5.59)	(122.17)	(15.75)	(9.65)	(19.05)	
15P6072	VEE	3/8	0.219	2.50	1.25		1.41		2.44	3.00	0.75	0.22	4.81	0.62	0.38	1.00	
15P6082	REG	(9.53)	(5.56)	(63.50)	(31.75)		(35.81)		(61.98)	(76.20)	(19.05)	(5.59)	(122.17)	(15.75)	(9.65)	(25.40)	
15P8072	VEE	1/2	0.312	3.00	1.50		2.06		3.38	4.00	1.00	0.34	6.43	0.69	0.50	1.38	
15P8082	REG	(12.70)	(7.92)	(76.20)	(38.10)		(52.32)		(85.85)	(101.60)	(25.40)	(8.64)	(163.32)	(17.53)	(12.70)	(35.05)	
10P12072	VEE	3/4	0.437	3.50	1.75		2.63		4.25	10.25	1.12	0.44	7.50	0.88	0.63	1.75	
10P12082	REG	(19.05)	(11.10)	(88.90)	(44.45)		(66.80)		(107.95)	(260.35)	(28.45)	(11.18)	(190.50)	(22.35)	(16.00)	(44.45)	
10P16072	VEE	1	0.562	4.12	2.06		3.31		5.12	10.25	1.62	0.56	9.00	1.25	1.13	1.75	
10P16082	REG	(25.40)	(14.27)	(104.65)	(52.32)		(84.07)		(130.05)	(260.35)	(41.15)	(14.22)	(228.60)	(31.75)	(28.70)	(44.45)	

3-Way / 2 on Pressure

15P4073	VEE	1/4	0.203	2.00	1.00		1.41		2.62	3.00	0.75	0.22	5.00	0.62	0.38	0.75	See Figure 3
15P4083	REG	(6.35)	(5.16)	(50.80)	(25.40)		(35.71)		(66.55)	(76.20)	(19.05)	(5.59)	(127.00)	(15.75)	(9.65)	(19.05)	
15P6073	VEE	3/8	0.219	2.50	1.25		1.41		2.62	3.00	0.75	0.22	5.00	0.62	0.38	1.00	
15P6083	REG	(9.53)	(5.56)	(63.50)	(31.75)		(35.71)		(66.55)	(76.20)	(19.05)	(5.59)	(127.00)	(15.75)	(9.65)	(25.40)	
15P8073	VEE	1/2	0.312	3.00	1.50		2.06		3.62	4.00	1.00	0.34	6.52	0.69	0.50	1.38	
15P8083	REG	(12.70)	(7.92)	(76.20)	(38.10)		(52.40)		(91.95)	(101.60)	(25.40)	(8.64)	(165.61)	(17.53)	(12.70)	(35.05)	
10P12073	VEE	3/4	0.437	3.50	1.75		2.65		4.62	10.25	1.12	0.44	7.88	0.88	0.63	1.75	
10P12083	REG	(19.05)	(11.10)	(88.90)	(44.45)		(67.31)		(117.35)	(260.35)	(28.45)	(11.18)	(200.15)	(22.35)	(16.00)	(44.45)	
10P16073	VEE	1	0.562	4.12	2.06		3.31		5.88	10.25	1.62	0.56	9.75	1.25	1.13	1.75	
10P16083	REG	(25.40)	(14.27)	(104.65)	(52.32)		(84.12)		(149.35)	(260.35)	(41.15)	(14.22)	(247.65)	(31.75)	(28.70)	(44.45)	

G - Packing gland mounting hole drill size

G₁ - Bracket mounting hole size

Panel mounting drill size: 0.22" all valves. Panel mount screws for the 1/8" NPT are M3.5 x .7 thd.

* H Dimension is with stem in closed position.

For prompt service, Parker Autoclave stocks select products. Consult factory.

All dimensions for reference only and subject to change.

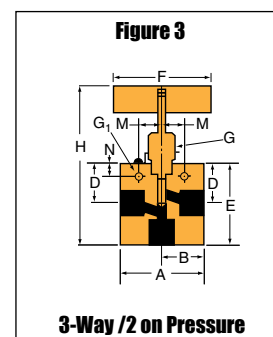
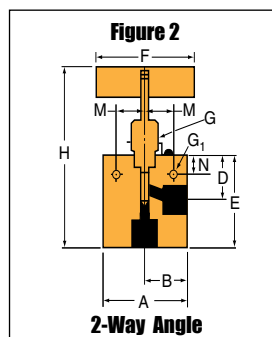
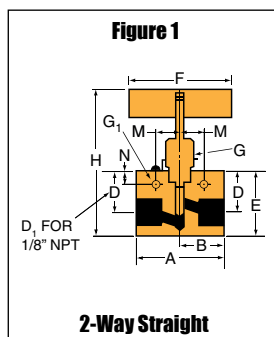

Catalog Number	Stem Type	Outside Diameter Tube	Orifice Diameter	Dimensions - inches (mm)												Block Thickness	Valve Pattern
				A	B	C	D	D ₁	E	F	G	G ₁	H*	M	N		

3-Way / 1 on Pressure

15P4074	VEE	1/4	.0203	2.00	1.00		1.41		2.44	3.00	0.75	0.22	4.81	0.62	0.38	0.75	See Figure 4
15P4084	REG	(6.35)	(5.16)	(50.80)	(25.40)		(35.71)		(61.98)	(76.20)	(19.05)	(5.59)	(122.17)	(15.75)	(9.65)	(19.05)	
15P6074	VEE	3/8	0.219	2.50	1.25		1.41		2.44	3.00	0.75	0.22	4.81	0.62	0.38	1.00	
15P6084	REG	(9.53)	(5.56)	(63.50)	(31.75)		(35.71)		(61.98)	(76.20)	(19.05)	(5.59)	(122.17)	(15.75)	(9.65)	(25.40)	
15P8074	VEE	1/2	0.312	3.00	1.50		2.06		3.38	4.00	1.00	0.34	6.31	0.69	0.50	1.38	
15P8084	REG	(12.70)	(7.92)	(76.20)	(38.10)		(52.40)		(85.85)	(101.60)	(25.40)	(8.64)	(160.27)	(17.53)	(12.70)	(35.05)	
10P12074	VEE	3/4	0.437	3.50	1.75		2.65		4.25	10.25	1.12	0.44	7.50	0.88	0.63	1.75	
10P12084	REG	(19.05)	(11.10)	(88.90)	(44.45)		(67.31)		(107.95)	(260.35)	(28.45)	(11.18)	(190.50)	(22.35)	(16.00)	(44.45)	
10P16074	VEE	1	0.562	4.12	2.06		3.31		5.12	10.25	1.62	0.56	9.09	1.25	1.13	1.75	
10P16084	REG	(25.40)	(14.27)	(104.65)	(52.32)		(84.07)		(130.05)	(260.35)	(41.15)	(14.22)	(230.89)	(31.75)	(28.70)	(44.45)	

3-Way/2-Stem Manifold

15P4075	VEE	1/4	0.203	2.00	1.00		1.69	1.19	3.38	3.00	0.75	0.22	5.75	0.62	0.38	0.75	See Figure 5
15P4085	REG	(6.35)	(5.16)	(50.80)	(25.40)		(42.88)	(30.18)	(85.85)	(76.20)	(19.05)	(5.59)	(146.05)	(153.75)	(9.65)	(19.05)	
15P6075	VEE	3/8	0.219	2.50	1.25		1.69	1.19	3.38	3.00	0.75	0.22	5.75	0.62	0.38	1.00	
15P6085	REG	(9.53)	(5.56)	(63.50)	(31.75)		(42.88)	(30.18)	(85.85)	(76.20)	(19.05)	(5.59)	(146.05)	(15.75)	(9.65)	(25.40)	
15P8075	VEE	1/2	0.312	3.00	1.50		2.56	1.75	5.12	4.00	1.00	0.34	8.05	0.69	0.50	1.38	
15P8085	REG	(12.70)	(7.92)	(76.20)	(38.10)		(65.07)	(44.45)	(130.05)	(101.60)	(25.40)	(8.64)	(204.47)	(17.53)	(12.70)	(35.05)	
10P12075	VEE	3/4	0.437	3.50	1.75		3.25	2.25	6.50	10.25	1.12	0.44	9.75	0.88	0.63	1.75	
10P12085	REG	(19.05)	(11.10)	(88.90)	(44.45)		(82.55)	(57.15)	(165.10)	(260.35)	(28.45)	(11.18)	(247.65)	(22.35)	(16.00)	(44.45)	
10P16075	VEE	1	0.562	4.12	2.06		3.75	2.81	7.50	10.25	1.62	0.56	11.47	1.25	1.13	1.75	
10P16085	REG	(25.40)	(14.27)	(104.65)	(52.32)		(95.25)	(71.42)	(190.50)	(260.35)	(41.15)	(14.22)	(291.38)	(31.75)	(28.70)	(44.45)	

G - Packing gland mounting hole drill size
 G₁ - Bracket mounting hole size
 Panel mounting drill size: 0.22" all valves.

*H Dimension is with stem in closed position.
 All dimensions for reference only and subject to change.

For prompt service, Parker Autoclave Engineers stocks select products. Consult factory.

NOTE: NPT (Pipe) Connections:

- NPT threads must be sealed using a high quality PTFE tape and/or paste product. Refer to thread sealant manufacturer's instructions on how to apply thread sealant.
- Sealing performance may vary based on many factors such as pressure, temperature, media, thread quality, thread material, proper thread engagement and proper use of thread sealant.
- Customer should limit the number of times an NPT fitting is assembled and disassembled because thread deformation during assembly will result in deteriorating seal quality over time. When using only PTFE tape, consider using thread lubrication to prevent galling of mating parts.

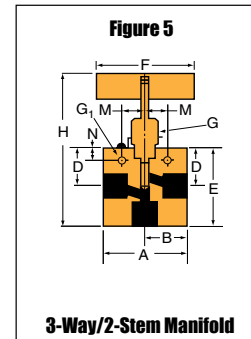
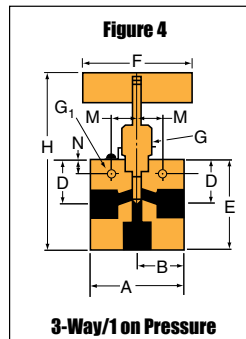

WARNING

FAILURE, IMPROPER SELECTION OR IMPROPER USE OF THE PRODUCTS AND/OR SYSTEMS DESCRIBED HEREIN OR RELATED ITEMS CAN CAUSE DEATH, PERSONAL INJURY AND PROPERTY DAMAGE.

This document and other information from Parker Hannifin Corporation, its subsidiaries and authorized distributors provide product and/or system options for further investigation by users having technical expertise. It is important that you analyze all aspects of your application and review the information concerning the product or system in the current product catalog. Due to the variety of operating conditions and applications for these products or systems, the user, through its own analysis and testing, is solely responsible for making the final selection of the products and systems and assuring that all performance, safety and warning requirements of the application are met. The products described herein, including without limitation, product features, specifications, designs, availability and pricing, are subject to change by Parker Hannifin Corporation and its subsidiaries at any time without notice.

Offer of Sale

The items described in this document are available for sale by Parker Hannifin Corporation, its subsidiaries or its authorized distributors. Any sale contract entered by Parker will be governed by the provisions stated in Parker's standard terms and conditions of sale (copy available upon request).

© 2013 Parker Hannifin Corporation | Autoclave Engineers is a registered trademark of the Parker Hannifin Corporation

02-1251SE January 2013



Instrumentation Products Division
 Autoclave Engineers Operation
 8325 Hessinger Drive
 Erie, Pennsylvania 16509-4679 USA
 PH: 814-860-5700 FAX: 814-860-5811
 www.autoclave.com

Parker Hannifin Manufacturing Ltd.
 Instrumentation Products Division, Europe
 Industrial Estate Whitemill
 Wexford, Republic of Ireland
 PH: 353 53 914 1566
 FAX: 353 53 914 1582

Caution! Do not mix or interchange parts or tubing with those of other manufacturers. Doing so is unsafe and will void warranty.

Caution! Parker Autoclave Engineers Valves, Fittings and Tools are not designed to work with common commercial instrument tubing and will only work with tubing built to Parker Autoclave Engineers AES Specifications. Failure to do so will void warranty.

ISO-9001 Certified