



aerospace
climate control
electromechanical
filtration
fluid & gas handling
hydraulics
pneumatics
process control
sealing & shielding



SWO Water/oil cooler

Lightweight, compact and efficient for industrial and marine applications



ENGINEERING YOUR SUCCESS.



The Olaer Group is part of Parker Hannifin since July 1st, 2012. With manufacturing and sales in 14 countries in North America, Asia and Europe, the Olaer Group expands Parker's presence in geographic growth areas and offers expertise in hydraulic accumulator and cooling systems for target growth markets such as oil and gas, power generation and renewable energy.

Shell & tube water/oil coolers

Theory and application of shell & tube water/oil coolers

Two fluids, of different starting temperatures, flow through the water oil cooler. One fluid flows through the internal tubes and the other flows around the tubes inside the shell. Heat is trans-

ferred from one fluid to the other through the tube walls, either from inside the tubes to the surrounding fluid or vice versa.

GWO water/oil coolers in short:

- **Light and compact**
- **Suitable for many applications**
- **Easy installation**
- **Cost-efficient and environmentally friendly**

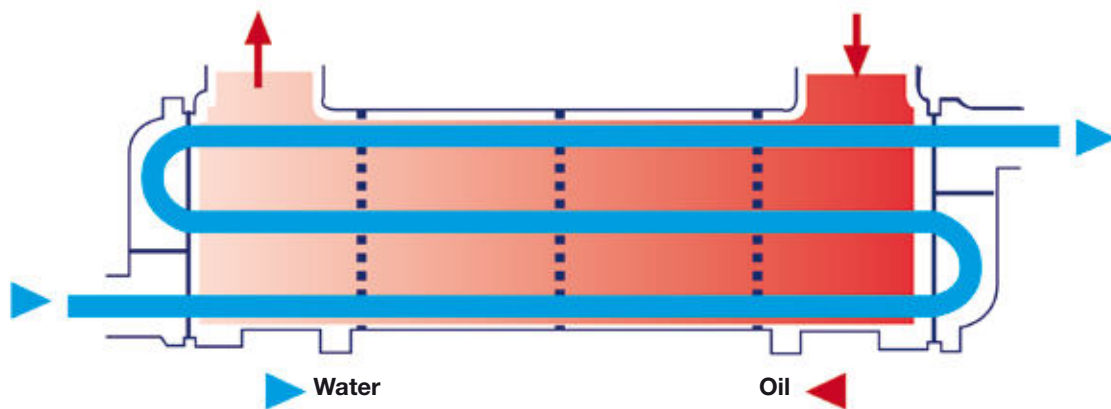

Flow range:	0 – 900 l/min
Design Pressure:	Oil side 15 bar / water side 10 bar
Max working temperature:	+95 °C with NBR seals
Connections:	¾" BSP - 3" BSP

Specifications may be changed without prior notice.
Please contact Parker for specific details.

Design attributes

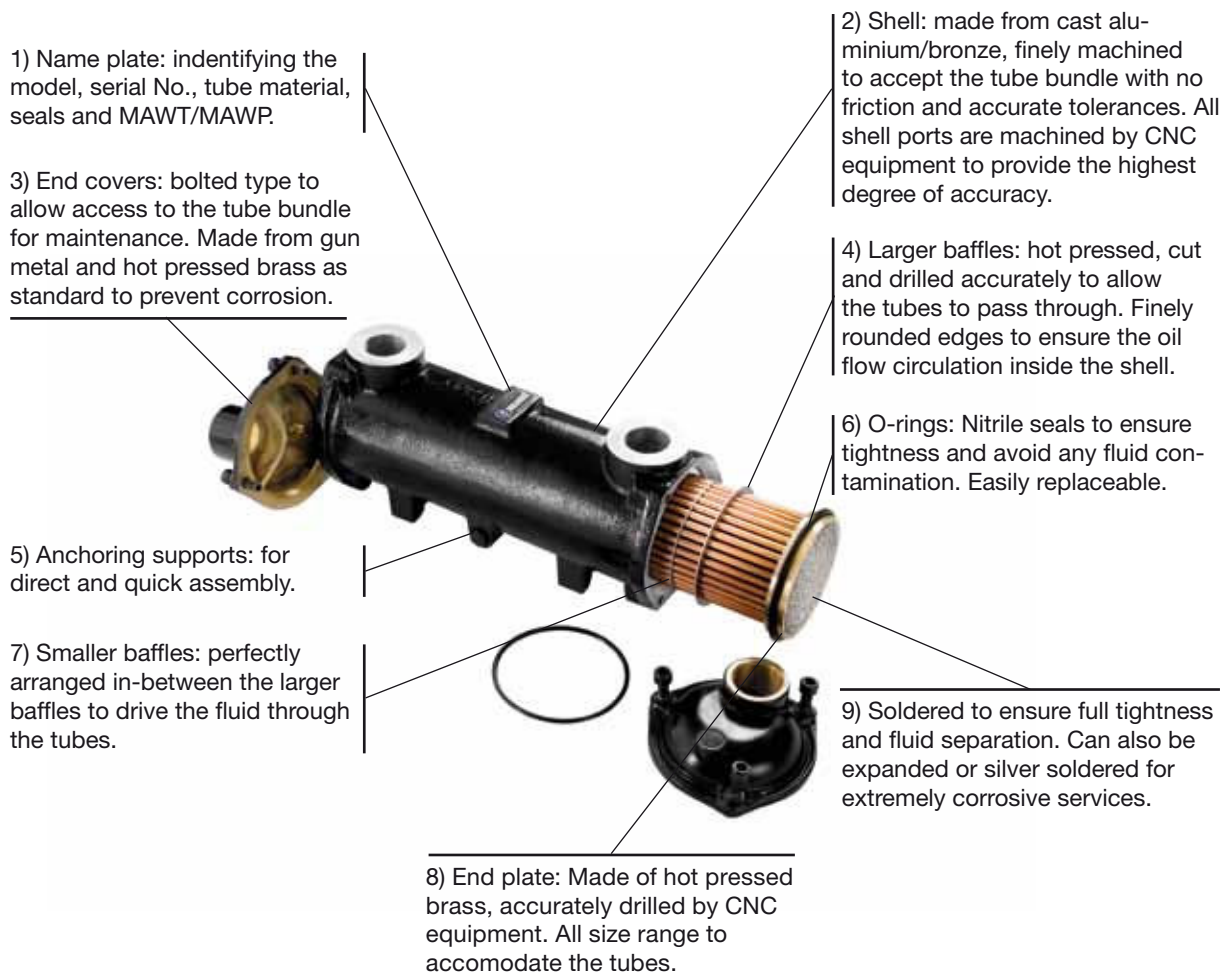

Design features

Parker SWO water/oil coolers are manufactured to cater for the most common power requirements in the hydraulics industry. The serialised manufactured units range from the smallest size (TP-A1) with 3 kW of heat dissipation power to the largest size (TP-F6) with 500 kW per average. Parker SWO Oil Coolers are of floating tube bundle design.

Materials of construction (primary standards in *italic*):

Industrial version:

- Shell: *Aluminium, Bronze*
- END COVERS: *Hot pressed brass, Bronze*

- TUBES: *Copper, CuNi 90/10*
- BAFFLES: *Aluminium*
- END PLATES: *Brass*
- O-Rings/Seals: *NITRILE*

Marine version:

- Shell: *Aluminium, Bronze*
- END COVERS: *Hot pressed brass, Bronze*
- TUBES: *Copper, CuNi 90/10*
- BAFFLES: *Aluminium*
- END PLATES: *Brass*
- O-Rings/Seals: *NITRILE*

Application limits

Maximum working temperature: 95 °C with NBR seals (this is the peak temperature and should not be understood as continuous service temps). Design Pressure:

Oil side 15 bar, water side 10 bar (pressure/temperature charts should be observed).

Installation and maintenance

The Parker SWO Water Oil Coolers may be installed vertically or horizontally but both fluids must circulate counter to current flow. The cooler could be installed in the return line to the tank or in a closed circuit, and bypass isolation be set in place to allow for maintenance. Consult your nearest Parker distributor for complete operating and maintenance booklets if not received along with the product, alternatively download them from www.parker.com.



Main dimensions and typical performance

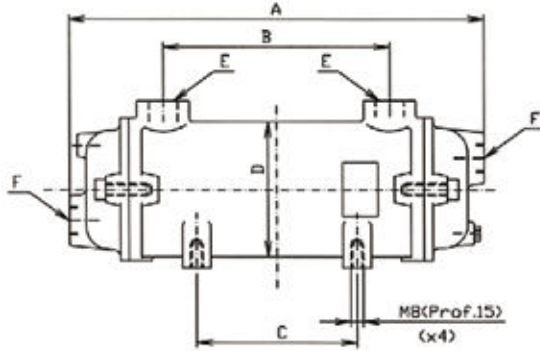

Type A, B and C

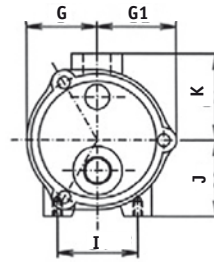

Type D, E and F

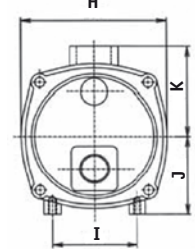

Model	Dimensions mm											Dis-sipated Power	Oil Flow Rate	Water Flow Rate	Oil Pres-sure Drop	Water Pres-sure Drop	Sur-face	Weight
	A	B	C	D	E	F	G	G1	H	I	J							
Tp-A 1	195	72	38	86	3/4"	50	55	-	54	55	60	3	30	15	0.10	0.02	0.13	3
Tp-A 2	263	142	106	86	3/4"	50	55	-	54	55	60	6	46	23	0.19	0.05	0.22	3.5
Tp-A 3	349	228	192	86	3/4"	50	55	-	54	55	60	9	56	28	0.36	0.09	0.32	4
Tp-A 4	448	326	290	86	3/4"	50	55	-	54	55	60	13	64	32	0.60	0.13	0.46	4.7
Tp-A 5	576	454	418	86	3/4"	50	55	-	54	55	60	16	56	28	0.56	0.12	0.68	5.5
Tp-B 1	273	123	109	108	1"	60	65	-	77	65	70	8	66	33	0.16	0.02	0.33	5
Tp-B 2	355	205	190	108	1"	60	65	-	77	65	70	12	80	40	0.32	0.03	0.48	6
Tp-B 3	452	302	289	108	1"	60	65	-	77	65	70	18	104	52	0.96	0.07	0.66	7
Tp-B 4	587	437	422	108	1"	60	65	-	77	65	70	25	106	53	1	0.11	0.90	8.2
Tp-B 5	730	580	566	108	1"	60	65	-	77	65	70	29	98	49	1.04	0.14	1.16	10
Tp-C 1	372	187	93	130	1 1/4"	70	80	-	77	75	80	16	100	50	0.28	0.04	0.64	9
Tp-C 2	472	287	193	130	1 1/4"	70	80	-	77	75	80	26	120	60	0.55	0.07	0.90	10
Tp-C 3	600	416	322	130	1 1/4"	70	80	-	77	75	80	36	140	70	0.74	0.13	1.23	12.5
Tp-C 4	744	559	465	130	1 1/4"	70	80	-	77	75	80	48	160	80	1.06	0.17	1.60	14.5
Tp-C 5	922	737	643	130	1 1/4"	70	80	-	77	75	80	56	140	70	0.95	0.16	2.07	17.5
Tp-D 1	505	273	109	162	1 1/2"	-	-	177	119	95	100	40	180	90	0.40	0.07	1.58	20
Tp-D 2	634	402	238	162	1 1/2"	-	-	177	119	95	100	52	200	100	0.55	0.09	2.14	24
Tp-D 3	780	548	384	162	1 1/2"	-	-	177	119	95	100	66	220	110	0.62	0.12	2.79	27
Tp-D 4	954	722	558	162	1 1/2"	-	-	177	119	95	100	84	240	120	0.80	0.16	3.57	32
Tp-D 5	1160	928	764	162	1 1/2"	-	-	177	119	95	100	108	260	130	1	0.19	4.48	38
Tp-D 6	1364	1132	968	162	1 1/2"	-	-	177	119	95	100	120	240	120	0.96	0.21	5.38	45
Tp-E 1	675	372	239	198	2"	-	-	206	120	110	120	76	320	160	0.44	0.09	3.27	33
Tp-E 2	816	513	380	198	2"	-	-	206	120	110	120	106	360	180	0.64	0.13	4.24	39
Tp-E 3	998	696	560	198	2"	-	-	206	120	110	120	134	400	200	0.90	0.20	5.45	45
Tp-E 4	1204	901	766	198	2"	-	-	206	120	110	120	175	420	210	1.10	0.25	6.82	54
Tp-E 5	1408	1102	968	198	2"	-	-	206	120	110	120	205	400	200	1.15	0.28	8.22	64
Tp-E 6	1712	1406	1272	198	2"	-	-	206	120	110	120	240	360	180	1.10	0.28	10.27	75
Tp-F 1	754	330	236	278	3"	-	-	288	180	155	170	133	720	360	0.36	0.09	7.20	47
Tp-F 2	900	476	382	278	3"	-	-	288	180	155	170	180	780	390	0.50	0.13	9.14	57
Tp-F 3	1077	654	560	278	3"	-	-	288	180	155	170	250	840	420	0.62	0.17	11.81	68
Tp-F 4	1280	856	762	278	3"	-	-	288	180	155	170	325	900	450	0.76	0.25	14.60	79
Tp-F 5	1484	1060	966	278	3"	-	-	288	180	155	170	410	960	480	1	0.32	17.30	91
Tp-F 6	1790	1364	1270	278	3"	-	-	288	180	155	170	500	900	450	1.16	0.52	21.54	105

DRAIN/VENT PLUGS

WATER SIDE (END COVERS)

For series A,B,C & D 1/4" BSP
 For series E & F 1/2" BSP

OIL SIDE (SHELL)

For series B,C & D 1/4" BSP
 For series E & F 1/2" BSP

There is no drain plug in the shell for A-serie.



The table to the left shows the typical performance of the standard range of Parker models. This table should be taken as a quick reference and always supported by more detailed performance graphs or the use of our software. The table is built using the following typical performance data: Oil Outlet temperature of 50 °C, Water Inlet temperature of 25 °C

and Oil Viscosity of 38 cSt. Any other parameter would alter the typical selection. Ask you nearest Parker distributor for the software, a powerful tool which will enhance your quotations, optimise your selection process and store a process fluid data base. Pressure drop diagrams are available from Parker.

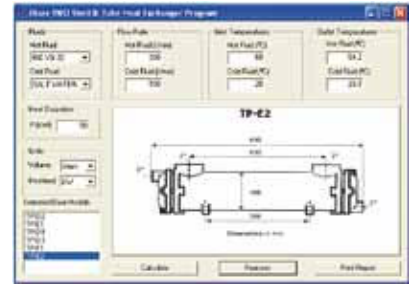

Industrial Shell & tube water/oil cooler

Series A - F / AM - FM

Parker SWO water/oil coolers are designed in a three pass tube stack arrangement. with cooling fluid inlet and outlet on opposite sides and counter-current flows. The tube stack is of the fully floating type, thus thermal stresses are minimised while mainte-

nance operations are kept to a minimum.

The Parker range of industrial SWO water/oil coolers is suitable for any sort of heat transfer fluids, heating or cooling process fluids.

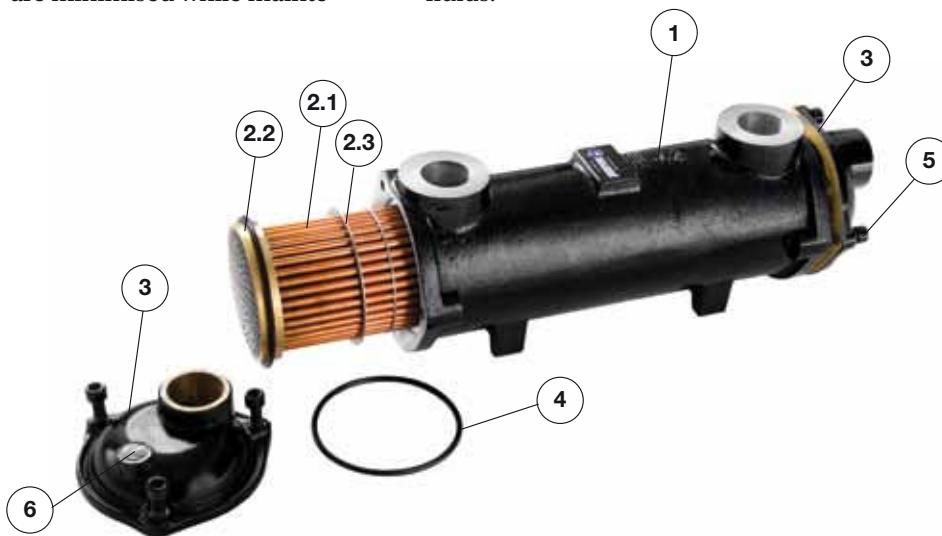

Part	Name	Material
1	Shell	Aluminium/Bronze
2	Tube Stack	
2.1	Tubes	Copper/Copper-Nickel
2.2	Tube plates	Brass
2.3	Baffles	Aluminium
	Welding	Soldered 60/40
3	End Caps	Brass/Bronze
4	Seals	NBR
5	Cover screws	Steel
6	Drain plugs	Brass

Industrial version:
copper tubes are standard.

Marine version:
copper-nickel tubes 90/10 are standard.



Performance graphs

Series A/AM

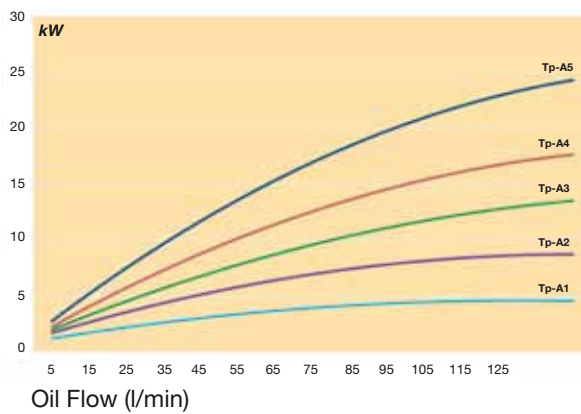

Series D/DM

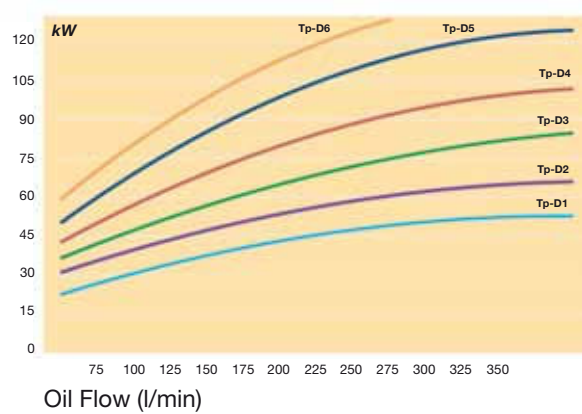

Series B/BM

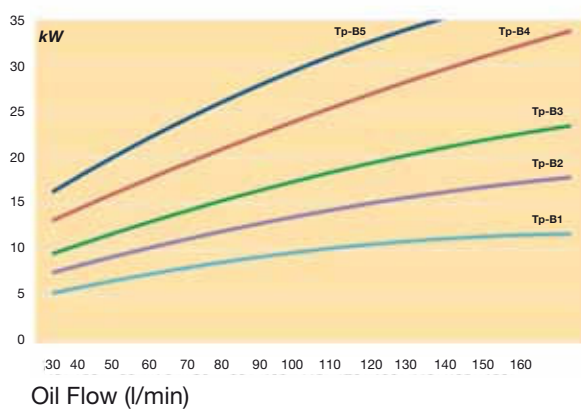

Series E/EM

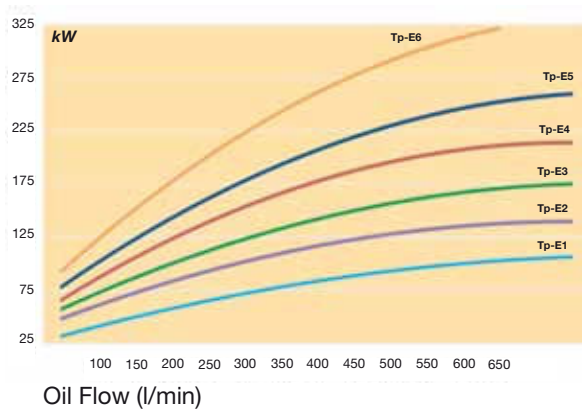

Series C/CM

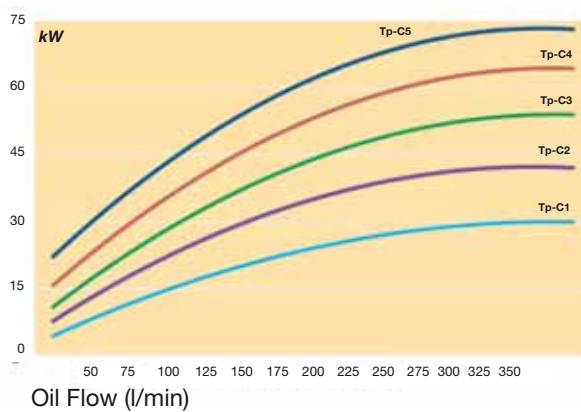

Series F/FM

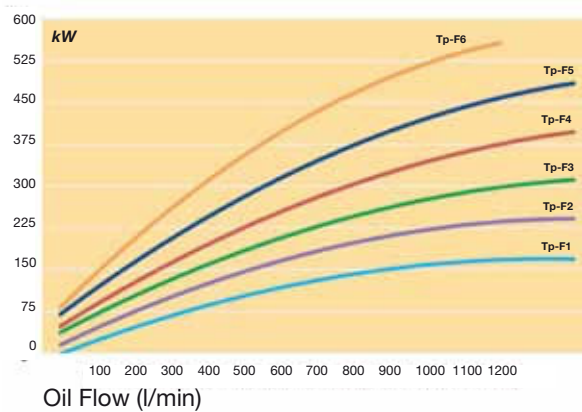

Graphs were plotted using the following parameters: $\Delta T = 25^\circ\text{C}$, Viscosity of oil: 38 cSt (SAE 30) and water.

Temperature Correction Factors
When temperature gap between

oil outlet and water inlet exceeds the given 25°C the following correction factors should be used:
 10°C : 0.4 / 15°C : 0.6 / 20°C : 0.8 / 30°C : 1.2 / 35°C : 1.4 / 40°C : 1.6
 (multiply kW by the suitable correction factor).

Flow Rate Correction Factors
For water flow rates other than 50% of the oil flow rate, the following correction factors should be used: 25%: 0.8 / 100%: 1.2
 (multiply the flow rate by the suitable correction factor).

The Olaer software is available also for units that fall outside the above curves. Data subject to technical modification without prior notice.



Oil pressure drop

Series A/AM

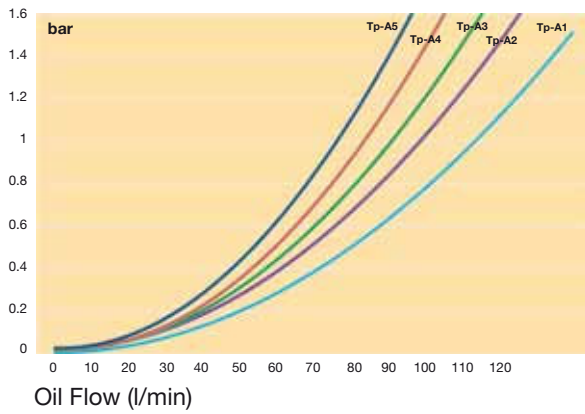

Series D/DM

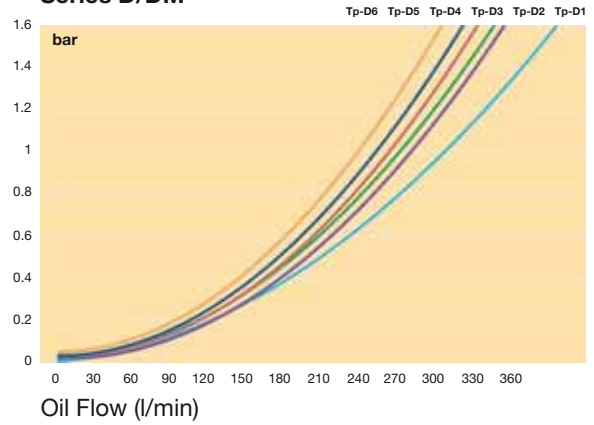

Series B/BM

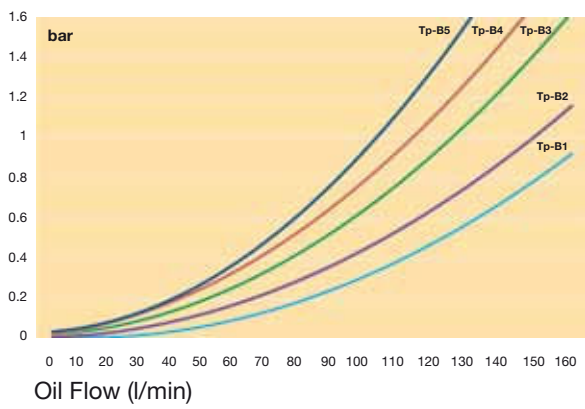

Series E/EM

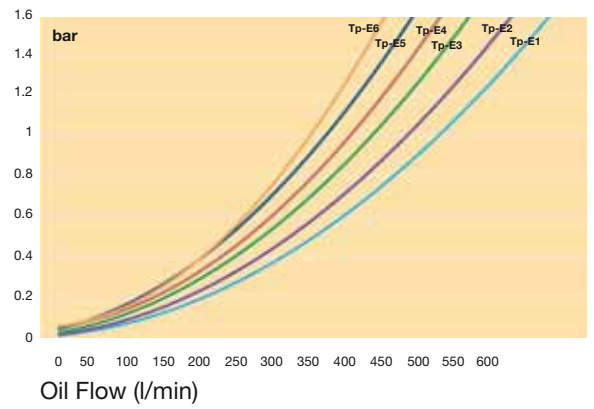

Series C/CM

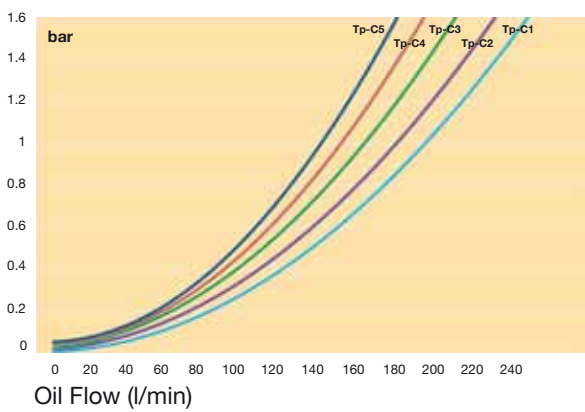

Series F/FM

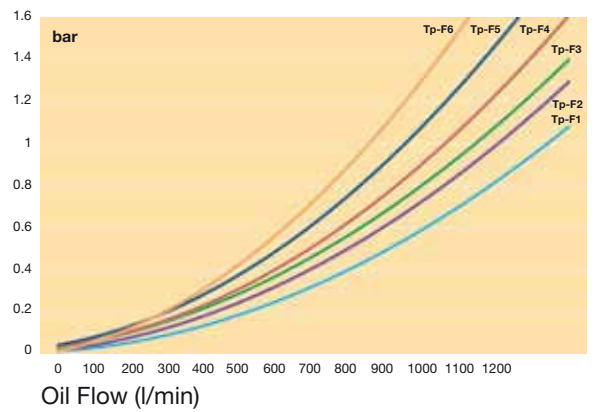

Parker Worldwide

Europe, Middle East, Africa

AE – United Arab Emirates, Dubai

Tel: +971 4 8127100
parker.me@parker.com

AT – Austria, Wiener Neustadt
Tel: +43 (0)2622 23501-0
parker.austria@parker.com

AT – Eastern Europe, Wiener Neustadt
Tel: +43 (0)2622 23501 900
parker.easteurope@parker.com

AZ – Azerbaijan, Baku
Tel: +994 50 22 33 458
parker.azerbaijan@parker.com

BE/LU – Belgium, Nivelles
Tel: +32 (0)67 280 900
parker.belgium@parker.com

BG – Bulgaria, Sofia
Tel: +359 2 980 1344
parker.bulgaria@parker.com

BY – Belarus, Minsk
Tel: +375 17 209 9399
parker.belarus@parker.com

CH – Switzerland, Etoy
Tel: +41 (0)21 821 87 00
parker.switzerland@parker.com

CZ – Czech Republic, Klecany
Tel: +420 284 083 111
parker.czechrepublic@parker.com

DE – Germany, Kaarst
Tel: +49 (0)2131 4016 0
parker.germany@parker.com

DK – Denmark, Ballerup
Tel: +45 43 56 04 00
parker.denmark@parker.com

ES – Spain, Madrid
Tel: +34 902 330 001
parker.spain@parker.com

FI – Finland, Vantaa
Tel: +358 (0)20 753 2500
parker.finland@parker.com

FR – France, Contamine s/Arve
Tel: +33 (0)4 50 25 80 25
parker.france@parker.com

GR – Greece, Athens
Tel: +30 210 933 6450
parker.greece@parker.com

HU – Hungary, Budaoers
Tel: +36 23 885 470
parker.hungary@parker.com

IE – Ireland, Dublin
Tel: +353 (0)1 466 6370
parker.ireland@parker.com

IT – Italy, Corsico (MI)
Tel: +39 02 45 19 21
parker.italy@parker.com

KZ – Kazakhstan, Almaty
Tel: +7 7273 561 000
parker.easteurope@parker.com

NL – The Netherlands, Oldenzaal
Tel: +31 (0)541 585 000
parker.nl@parker.com

NO – Norway, Asker
Tel: +47 66 75 34 00
parker.norway@parker.com

PL – Poland, Warsaw
Tel: +48 (0)22 573 24 00
parker.poland@parker.com

PT – Portugal, Leca da Palmeira
Tel: +351 22 999 7360
parker.portugal@parker.com

RO – Romania, Bucharest
Tel: +40 21 252 1382
parker.romania@parker.com

RU – Russia, Moscow
Tel: +7 495 645-2156
parker.russia@parker.com

SE – Sweden, Spånga
Tel: +46 (0)8 59 79 50 00
parker.sweden@parker.com

SK – Slovakia, Banská Bystrica
Tel: +421 484 162 252
parker.slovakia@parker.com

SL – Slovenia, Novo Mesto
Tel: +386 7 337 6650
parker.slovenia@parker.com

TR – Turkey, Istanbul
Tel: +90 216 4997081
parker.turkey@parker.com

UA – Ukraine, Kiev
Tel: +380 44 494 2731
parker.ukraine@parker.com

UK – United Kingdom, Warwick
Tel: +44 (0)1926 317 878
parker.uk@parker.com

ZA – South Africa, Kempton Park
Tel: +27 (0)11 961 0700
parker.southafrica@parker.com

North America

CA – Canada, Milton, Ontario
Tel: +1 905 693 3000

US – USA, Cleveland (industrial)
Tel: +1 216 896 3000

US – USA, Elk Grove Village (mobile)
Tel: +1 847 258 6200

Asia Pacific

AU – Australia, Castle Hill
Tel: +61 (0)2-9634 7777

CN – China, Shanghai
Tel: +86 21 2899 5000

HK – Hong Kong
Tel: +852 2428 8008

IN – India, Mumbai
Tel: +91 22 6513 7081-85

JP – Japan, Fujisawa
Tel: +81 (0)4 6635 3050

KR – South Korea, Seoul
Tel: +82 2 559 0400

MY – Malaysia, Shah Alam
Tel: +60 3 7849 0800

NZ – New Zealand, Mt Wellington
Tel: +64 9 574 1744

SG – Singapore
Tel: +65 6887 6300

TH – Thailand, Bangkok
Tel: +662 717 8140

TW – Taiwan, New Taipei City
Tel: +886 2 2298 8987

South America

AR – Argentina, Buenos Aires
Tel: +54 3327 44 4129

BR – Brazil, Cachoeirinha RS
Tel: +55 51 3470 9144

CL – Chile, Santiago
Tel: +56 2 623 1216

MX – Mexico, Apodaca
Tel: +52 81 8156 6000

EMEA Product Information Centre

Free phone: 00 800 27 27 5374

(from AT, BE, CH, CZ, DE, DK, EE, ES, FI, FR, IE, IL, IS, IT, LU, MT, NL, NO, PL, PT, RU, SE, SK, UK, ZA)

US Product Information Centre

Toll-free number: 1-800-27 27 537

www.parker.com

