

## Tube flange type heavy-duty hydraulic cylinders for 14 MPa

- 14 MPa tube flange type double acting hydraulic cylinders with bores size from 63 to 160 mm applicable to strokes length from 200 to 3000 mm.
- High-performance cushion reduces a shock at stroke-end.
- Newly designed cushion valve allows easy cushion adjustment.
- The drop prevention mechanism and looseness preventive lock nut have been adopted as safety measures for the cushion valve.
- The adaption of O-ring seal for cover and screwed tube flange.
- The use of more durable mounting accessories than those of 140H-8.

### Standard Specifications

Type	Standard type	
Nominal pressure	14 MPa	
Maximum allowable pressure	Rod side: Rod A 18 MPa Rod B 18 MPa      Cap side: Rod A 18 MPa Rod B 18 MPa	
Proof test pressure	21 MPa	
Minimum operating pressure	Rod side: Rod A 0.6 MPa or less Rod B 0.45 MPa or less      Cap side: 0.3 MPa or less	
Working speed range (excluding cushion)	20 to 200 mm/s	
Working temperature range (ambient/fluid temperature)	-10 to +80°C (No freezing)	
Structure of cushioning	Metal fitting system	
Adaptable fluid	Petroleum-based fluid (When using another fluid, refer to the table of fluid adaptability.)	
Tolerance for thread	JIS 6g/6H (equivalent to JIS Class 2)	
Tolerance of stroke	200 to 630mm <sup>+1.25</sup> <sub>0</sub> 631 to 1000mm <sup>+1.4</sup> <sub>0</sub> 1001 to 1600mm <sup>+1.6</sup> <sub>0</sub> 1601 to 2500mm <sup>+1.8</sup> <sub>0</sub> 2501 to 3000mm <sup>+3.0</sup> <sub>0</sub>	
Mounting style	LA, FA, FB, CA, CB, TA, TC	
Accessories	Boots	Standard: Nylon tarpaulin    Semi-standard: Chloroprene, Conex
	Rod end attachments	Rod eye (T-end), rod clevis (Y-end) with pin
	Other	Lock nut

### Standard Stroke Range Unit: mm

Bore	Stroke
φ63 to φ160	200 to 3000

- The above strokes indicate the maximum available strokes for the standard type.
- For the rod buckling, check with the buckling chart in the selection materials. Contact us for longer strokes.

### Cushion Stroke Length Unit: mm

Bore	Cushion ring length L	Cushion ring parallel part length $l_1$	Piston rod parallel part length $l_2$
φ63	25	7	10
φ80 to φ125	30	8	15
φ140-φ160	30	12	15

- The cushion stroke lengths in case of cylinders used up to the stroke end.
- In the case that a cylinder is not used up to the stroke end, and it is stopped 5 mm or more before the stroke end, the cushioning effect will be weakened. In such a case, consult us.



### Terminologies

#### Nominal pressure

Pressure given to a cylinder for convenience of naming. It is not always the same as the working pressure (rated pressure) that guarantees

#### Maximum allowable pressure

The maximum allowable pressure generated in a cylinder (surge pressure, etc.).

#### Proof test pressure

Test pressure against which a cylinder can withstand without unreliable performance at the return to nominal pressure.

#### Minimum operating pressure

The minimum pressure that a cylinder placed horizontally without a load can work.

- Notes
- The hydraulic pressure generated in a cylinder due to the inertia of load must be lower than the maximum allowable pressure.
  - In case that the lock nut is attached to the piston rod end thread part, increase the thread length (dimension A).
  - For the internal structure, refer to the sectional drawings at the end of this catalog.
  - Conex, material of the boots, is the registered trademark of Teijin Limited.

### Product Lineup

Unit: mm

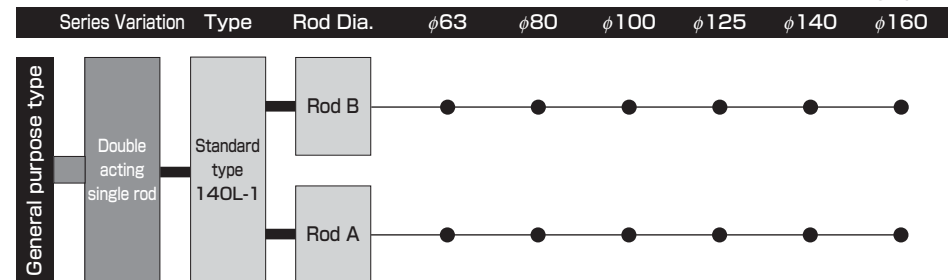

### Adaptability of Fluid to Seal Material

Seal material	Adaptable fluid				
	Petroleum-based fluid	Water-glycol fluid	Phosphate ester fluid	Water in oil fluid	Oil in water fluid
1 Nitrile rubber	○	○	×	○	○
2 Urethane rubber	◎	×	×	△	△
3 Fluorocarbon	○	×	○	○	○
6 HNBR	○	◎	×	◎	◎

- Notes) 1. ◎○: Applicable, ×: Inapplicable. Consult us before using the △-marked items.  
2. The ◎-marked items are recommended seal materials in case of giving the first priority to abrasion resistance.

### Weight Table

Unit: kg

Bore mm	Rod type	Basic weight (SD style)	Additional weight per mm of stroke	Mounting accessory weight								Rod end attachment weight			
				LA		FA	FB	CA	CB	TA	TC	Rod eye (T-end)	Rod clevis (Y-end)	With lock nut	
				w/ intermediate support	w/o intermediate support									Nut only	Standard
φ63	A	12.8	0.021	1.12	2.36	1.65	2.68	1.46	2.06	0.54	1.61	—	—	0.48	0.81
	B	12.3	0.016	1.12	2.36	1.50	2.68	1.46	2.06	0.54	1.61	2.51	3.97	0.22	0.36
φ80	A	21.8	0.033	1.57	3.22	2.54	4.04	2.44	3.62	1.17	2.85	—	—	0.91	1.48
	B	20.8	0.026	1.57	3.22	2.09	4.04	2.44	3.62	1.17	2.85	3.77	6.54	0.48	0.81
φ100	A	33.0	0.051	2.44	5.44	5.10	7.68	4.90	7.14	2.87	5.52	—	—	1.84	3.10
	B	31.2	0.041	2.44	5.44	4.22	7.68	4.90	7.14	2.82	5.52	7.47	12.62	0.91	1.48
φ125	A	58.9	0.083	4.40	9.42	7.20	12.63	8.76	13.64	5.01	11.26	—	—	3.23	5.80
	B	56.6	0.063	4.40	9.42	6.18	12.63	8.76	13.64	5.01	11.26	12.41	22.96	1.84	3.10
φ140	A	86.5	0.108	8.18	14.89	8.68	16.80	11.73	18.65	7.55	15.76	—	—	5.16	9.60
	B	81.7	0.086	8.18	14.89	7.08	16.80	11.73	18.65	7.44	15.76	19.17	33.75	2.50	4.42
φ160	A	116.7	0.127	13.21	24.71	13.06	25.26	17.46	26.40	12.68	20.63	—	—	6.22	11.14
	B	111.9	0.103	13.21	24.71	10.87	25.26	17.46	26.40	12.07	20.63	26.97	46.72	3.23	5.80

- Notes) ● The lock nut long thread weight applies in the case where the lock nut symbol is K. The lock nut weight includes the weight of the extended part of the thread length.  
● The rod eye and rod clevis are dedicated to the rod B. When the rod A is used, change the rod end thread diameter to that of the rod B.

Calculation formula) Cylinder weight (kg)=basic weight+(cylinder stroke (mm)×additional weight per mm of stroke)+mounting accessory weight+rod end attachment weight

Calculation example) 140L-1, rod B, bore φ100, cylinder stroke 2000 mm, LA style (without support)  
31.2+(2000×0.041)+2.44=115.64kg

### How to order

#### General Purpose Type

The item enclosed by broken line needs not to be entered, if unnecessary. Semi-standard specification

● Standard type 140L-1 2 LA 63 B B 2000 - G A B - T K - J

1 Nitrile rubber  
2 Urethane rubber  
3 Fluorocarbon  
6 HNBR

Note) The rods A of cylinders with bores from 140 and 160 mm are made of 1) or 2).

Mounting style  
φ63·φ80·φ100·φ125·φ140·φ160

A Rod A  
B Rod B

B With cushions on both ends  
R With cushion on rod side  
H With cushion on cap side  
N No cushion

Cushion valve position (A, B, C, D, O)  
Port position (A, B, C, D)

None Rc thread  
G G thread

Cylinder stroke (mm)

11 Nitrile rubber  
12 Urethane rubber  
13 Fluorocarbon  
16 HNBR

14 Nylon tarpaulin  
15 Chloroprene  
16 Conex

17 Long thread with lock nut

The rod end thread length (dimension A) is longer. For details, refer to the following description.

18 Rod eye (T-end)  
19 Rod clevis (Y-end)

The rod end attachments are dedicated to the rod B. To use them for the rod A, give instructions to change the rod end thread length to that of the rod B. For details, refer to the following description.

20 Cushion valve position (A, B, C, D, O)  
21 Port position (A, B, C, D)

22 None Rc thread  
23 G thread

Cylinder stroke (mm)

#### Standard specifications

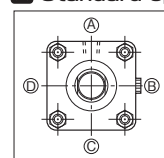

- With cushions on both ends
- Port position (A), cushion valve position (B)

Note) There are check valves on two sides out of the four outer sides of cap and rod covers except the port and cushion sides. The check valve is concurrently used with air vent.

#### Change of port position

When modifying the positions, enter the symbol shown in the dimensional drawings.

(Example) 140L-1 2LA63BB2000-B A - J

Port position (A, B, C, D)  
Cushion valve position (A, B, C, D, O)

- In case that the cushion is not equipped, the cushion valve position is 0.
- In case of the mounting style LA, the port and cushion valve are positioned on A, B or D. If you want to position any of them on C, contact us.

#### Delivery of rod end attachment (T-end or Y-end)

A delivery method for a cylinder provided with a lock nut and a rod end attachment differs from that for a cylinder provided with a rod end attachment only (without a lock nut). For details, refer to the dimensional drawings of rod end attachments.

#### Port G thread type

For a port G thread type cylinder, make an order in accordance with the following procedure.

(Example) 140L-1 2LA63BB2000-G A B - J

Port G thread type  
Port position  
Cushion valve position

#### Notes on ordering cylinder with lock nut

The rod end thread length (dimension A) is longer when a lock nut is attached to the rod end.

(Example) 140L-1 2LA63BB2000-A B - K  
Long thread with lock nut

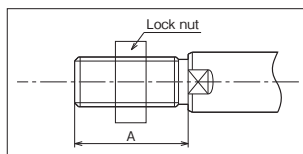

Dimension A without lock nut A=35  
↓  
Dimension A of long thread with lock nut A=60

Note) When a lock nut is attached to the rod end, dimension A must be equal to or longer than that of the long thread with lock nut. For details, refer to the dimensional drawings of rod end attachments.

#### Notes on ordering cylinder with rod end attachment for rod A

When the cylinder uses the rod A and has a rod end attachment, give instructions to change the standard rod A end thread diameter, pitch and length to those of the standard rod B.

(Example) 140L-1 2LA63AB2000-A B - T

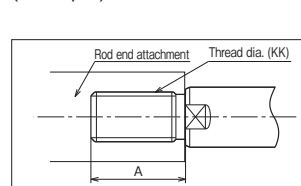

Standard rod A  
KK=M39×1.5  
A=45  
↓  
Standard rod B  
KK=M30×1.5  
A=35

Note) For details, refer to the dimensional drawings of rod end attachments.

(Example) 140L-1 2LA63AB2000-A B - T K  
Rod end attachment (T-end)  
Long thread with lock nut

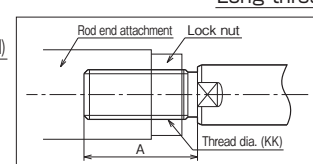

Standard rod A  
KK=M39×1.5  
A=45  
↓  
Rod B  
KK=M30×1.5  
A=60 (long thread)

Note) When a lock nut is attached to the rod end, dimension A must be equal to or longer than that of the long thread with lock nut. For details, refer to the dimensional drawings of rod end attachments.

#### Notes on ordering cylinder with rod end attachment for rod A and lock nut

When the cylinder uses the rod A and has a rod end attachment and a lock nut, change the standard rod A end thread diameter, pitch and length to those of the rod B, and specify a larger thread length (dimension A).

#### Semi-standard range

- Change of piston rod end
- Change of TC accessory position (dimensional symbol: PH)
- With boots
- Plated cylinder tube (hard chrome plating thickness: 0.02 mm)
- Specification of working fluid (water-glycol fluid)

#### Mounting style

LA LA style (side lugs)

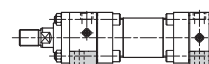

CA CA style (cap eye)

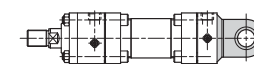

TA TA style (rod trunnion)

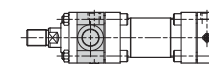

FA FA style (rod flange)



CB CB style (cap clevis)



TC TC style (intermediate trunnion)



FB FB style (cap flange)



Cushion valve and check valve (air vent) positions depending on cylinder bore (when port is on A and cushion is on B)

#### Rod A

Bore 63 to 160 mm

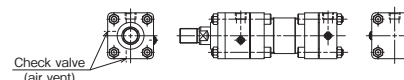

#### Rod B

Bore 63 to 140 mm

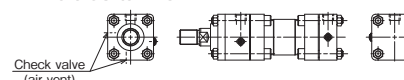

Bore 160 mm

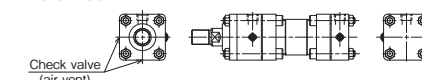

CAD/DATA 140L-1/THL1 Bore A, B is available.

### LA

140L-1 2 LA Bore B B Stroke

Port G thread type

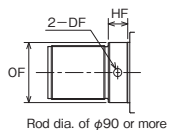
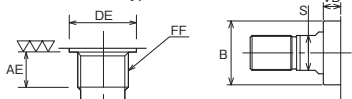

Rod dia.	OF	DF	HF
φ90	φ89.5	φ12	28
φ100	φ99.5	φ12	28
φ110	φ109.5	φ15	30

Note) The diameter of the rod B of 160 mm bore cylinder is 90 mm, but it is the width across flats.

φ63, 80: Max. 10  
φ100, 125: Max. 11  
φ140, 160: Max. 13

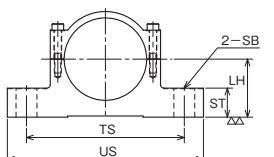
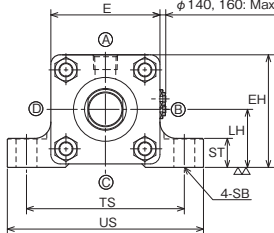

Detailed drawing of intermediate support

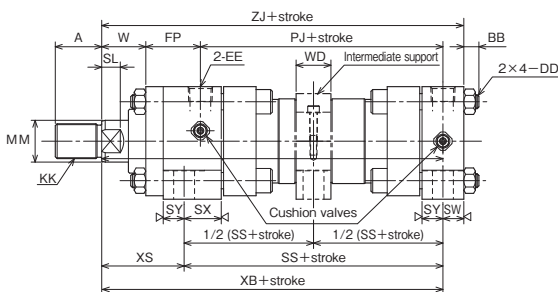

- The positions of cushion valves depend on the cylinder bore.
- For the thread length (dimension A) when the lock nut is used, refer to "Lock nut".
- For a cylinder with a port or a cushion valve on the © side, consult us.
- When the port is on the ⓑ or ⓓ side, it is positioned as shown below.

- When the stroke is 2501 to 3000 mm, an intermediate support for preventing deflection is provided around the center of the cylinder tube.
- If you want to change the rod protrusion length, specify dimension W.

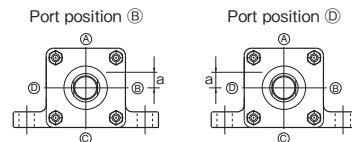

Note) Dimension a in case of port position on ⓑ or ⓓ

Bore	φ63	φ80	φ100	φ125	φ140	φ160
Symbol						
a	6	10	10	10	0	0

### With Boots

140L-1/THL1 Bore K

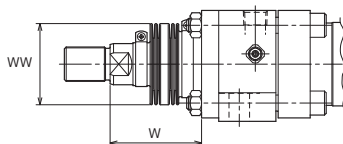

	Standard	Semi-standard	
Material	Nylon tarpaulin	Chloroprene	Conex
Heat proof	80°C	130°C	200°C

Notes) • Remember that the heat proof field in the table above shows the allowable temperatures for the boots, not for the cylinder.  
• The boots have been mounted at our factory prior to delivery.  
• Conex is the registered trademark of Teijin Limited.

### Rod A

Nylon tarpaulin	(φ63·φ80 1/4 stroke+X)
Chloroprene	(φ100 to φ160 1/5 stroke+X)
Conex	(φ63·φ80 1/3 stroke+X)
	(φ100 1/3.5 stroke+X)
	(φ125 to φ160 1/4 stroke+X)

### Dimension W

#### Rod B

Nylon tarpaulin	(φ63 to φ100 1/4 stroke+X)
Chloroprene	(φ125 to φ160 1/5 stroke+X)
Conex	(φ63 to φ100 1/3 stroke+X)
	(φ125·φ140 1/3.5 stroke+X)
	(φ160 1/4 stroke+X)

- If the calculated value has a fractional part, round it up.

### Dimensional Table

Symbol	Rod B							Rod A								
	A	B	KK	MM	S	SL	VD	W	A	B	KK	MM	S	SL	VD	W
φ63	35	φ55	M30×1.5	φ36	30	16	15	43	45	φ65	M39×1.5	φ45	41	20	19	43
φ80	45	φ65	M39×1.5	φ45	41	20	12	48	55	φ80	M48×1.5	φ56	50	23	19	48
φ100	55	φ80	M48×1.5	φ56	50	23	15	53	75	φ95	M64×2	φ70	65	27	19	53
φ125	75	φ95	M64×2	φ70	65	27	19	60	90	φ120	M80×2	φ90	-	-	28	60
φ140	80	φ105	M72×2	φ80	75	31	15	60	105	φ130	M95×2	φ100	-	-	24	60
φ160	90	φ120	M80×2	φ90	85	33	15	60	110	φ140	M100×2	φ110	-	-	24	60

Symbol	AE	BB	DD	DE	E	EE	EH	FF	FP	LH	PJ	SB	SS	ST	SW	SX	SY
φ63	14	15 or less	M14×1.5	φ30	□94	Rc1/2	97	G1/2	47	50±0.15	109	φ18	123	25	18	32	18
φ80	16	19 or less	M16×1.5	φ36.9	□114	Rc3/4	117	G3/4	57	60±0.25	125	φ18	143	30	20	39	21
φ100	16	19 or less	M18×1.5	φ36.9	□135	Rc3/4	137.5	G3/4	61	70±0.25	132	φ22	150	35	18	37	23
φ125	18	24 or less	M22×1.5	φ46.1	□165	Rc1	167.5	G1	73	85±0.25	150	φ26	173	45	23	47	28
φ140	18	25 or less	M27×2	φ46.1	□192	Rc1	196	G1	81	100±0.25	160	φ30	183	45	28	47	28
φ160	18	30 or less	M30×2	φ46.1	□218	Rc1	224	G1	86	115±0.25	179	φ33	202	55	30	45	30

Symbol	TS	US	WD	XB	XS	ZJ
φ63	136	169	30	199	76	217
φ80	155	190	30	230	87	250
φ100	190	230	40	248	98	266
φ125	224	272	50	285	112	308
φ140	262	320	50	303	120	331
φ160	294	356	65	329	127	359

### With Boots

Symbol	Rod B		Rod A	
	WW	X	WW	X
φ63	φ71	55	φ80	55
φ80	φ80	55	φ100	55
φ100	φ100	55	φ125	65
φ125	φ125	65	φ140	65
φ140	φ125	65	φ160	65
φ160	φ140	65	φ180	65

CAD/DATA 140L-1/THL1 [Bore] A, B is available.

### FA

140L-1 2 FA [Bore] B Stroke

Rod dia.	OF	DF	HF
φ90	φ89.5	φ12	28
φ100	φ99.5	φ12	28
φ110	φ109.5	φ15	30

Note) The diameter of the rod B of 160 mm bore cylinder is 90 mm, but it is the width across flats.

Port G thread type

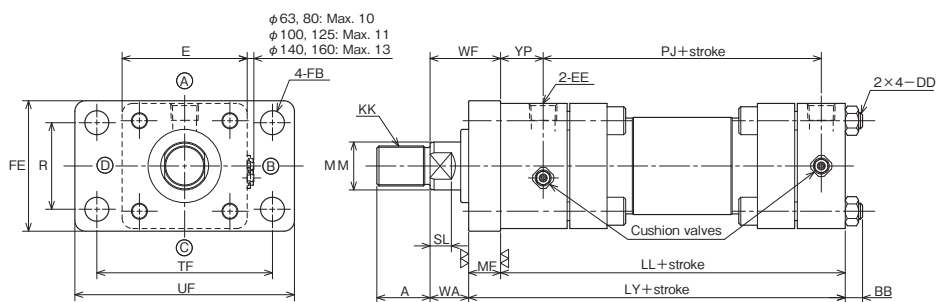
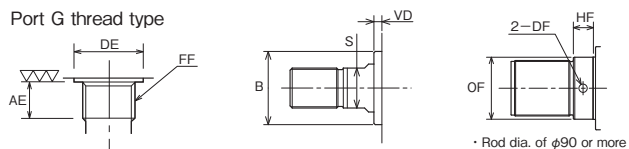

- The positions of cushion valves depend on the cylinder bore.
- If you want to change the rod protrusion length, specify dimension WA.
- For the thread length (dimension A) when the lock nut is used, refer to "Lock nut".

### With Boots

140L-1/THL1 [Bore] K

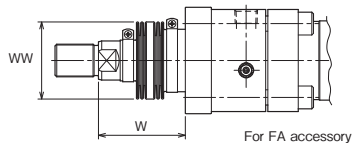

	Standard		Semi-standard	
	Material	Heat proof	Material	Heat proof
	Nylon tarpaulin	80°C	Chloroprene	130°C
	Conex	200°C	Conex	200°C

Notes) • Remember that the heat proof field in the table above shows the allowable temperatures for the boots, not for the cylinder.

- The boots have been mounted at our factory prior to delivery.
- Conex is the registered trademark of Teijin Limited.

### Dimension W

Material	Rod B	Stroke
Nylon tarpaulin	φ63 to φ100	1/4 stroke+X
	φ125 to φ160	1/5 stroke+X
Chloroprene	φ63 to φ100	1/3 stroke+X
	φ125 to φ140	1/3.5 stroke+X
Conex	φ160	1/4 stroke+X

### Rod A

Material	Rod A	Stroke
Nylon tarpaulin	φ63 to φ80	1/4 stroke+X
	φ100 to φ160	1/5 stroke+X
Chloroprene	φ63 to φ80	1/3 stroke+X
	φ100 to φ160	1/3.5 stroke+X

- If the calculated value has a fractional part, round it up.
- The gland bush for the mounting style FA differs from that for a cylinder with boots.

### Dimensional Table

Symbol Bore	Rod B									Rod A								
	A	B	KK	MM	S	SL	VD	WA	WF	A	B	KK	MM	S	SL	VD	WA	WF
φ63	35	φ55	M30×1.5	φ36	30	16	6	34	58	45	φ65	M39×1.5	φ45	41	20	10	34	58
φ80	45	φ65	M39×1.5	φ45	41	20	6	42	66	55	φ80	M48×1.5	φ56	50	23	13	42	66
φ100	55	φ80	M48×1.5	φ56	50	23	6	44	75	75	φ95	M64×2	φ70	65	27	10	44	75
φ125	75	φ95	M64×2	φ70	65	27	6	47	84	90	φ120	M80×2	φ90	-	-	15	47	84
φ140	80	φ105	M72×2	φ80	75	31	6	51	92	105	φ130	M95×2	φ100	-	-	15	51	92
φ160	90	φ120	M80×2	φ90	85	33	6	51	97	110	φ140	M100×2	φ110	-	-	15	51	97

Symbol Bore	AE	BB	DD	DE	E	EE	FB	FF	FE		LL	LY	MF	PJ	R	TF
									Rod B	Rod A						
φ63	14	15 or less	M14×1.5	φ30	□94	Rc1/2	φ18	G1/2	98	105	159	183	24	109	65	132
φ80	16	19 or less	M16×1.5	φ36.9	□114	Rc3/4	φ18	G3/4	125	140	184	208	24	125	87	155
φ100	16	19 or less	M18×1.5	φ36.9	□135	Rc3/4	φ22	G3/4	150	165	191	222	31	132	109	190
φ125	18	24 or less	M22×1.5	φ46.1	□165	Rc1	φ26	G1	175	195	224	261	37	150	130	224
φ140	18	25 or less	M27×2	φ46.1	□192	Rc1	φ30	G1	195	215	234	275	41	160	145	250
φ160	18	30 or less	M30×2	φ46.1	□218	Rc1	φ33	G1	225	245	253	299	46	179	170	285

Symbol Bore	UF	YP
φ63	165	32
φ80	190	39
φ100	230	39
φ125	272	49
φ140	300	49
φ160	345	49

### With Boots

Symbol Bore	Rod B		Rod A	
	WW	X	WW	X
φ63	φ71	55	φ80	55
φ80	φ80	55	φ100	55
φ100	φ100	55	φ125	65
φ125	φ125	65	φ140	65
φ140	φ125	65	φ160	65
φ160	φ140	65	φ180	65

CAD/DATA 140L-1/THL1 [Bore] A, B is available.

### FB

140L-1 [2] FB [Bore] [B] [Stroke]

Port G thread type

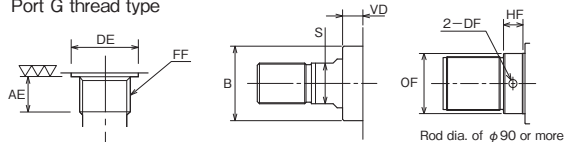

Rod dia.	OF	DF	HF
φ90	φ89.5	φ12	28
φ100	φ99.5	φ12	28
φ110	φ109.5	φ15	30

Note) The diameter of the rod B of 160 mm bore cylinder is 90 mm, but it is the width across flats.

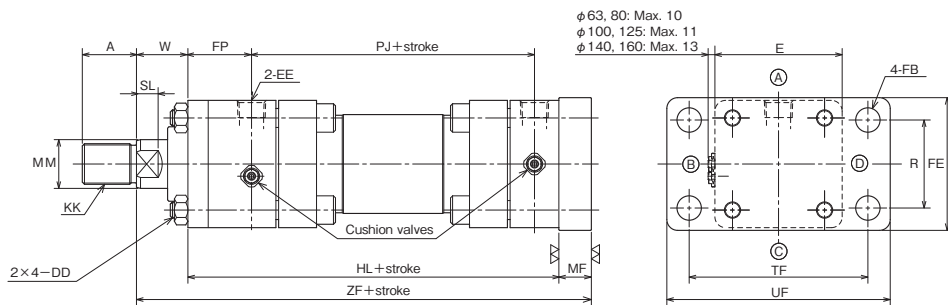

- The positions of cushion valves depend on the cylinder bore.
- For the thread length (dimension A) when the lock nut is used, refer to "Lock nut".

- If you want to change the rod protrusion length, specify dimension W.

### With Boots

140L-1/THL1 [Bore] K

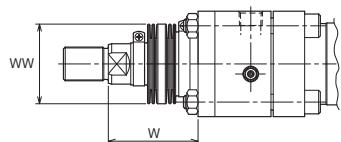

	Standard	Semi-standard	
Material	Nylon tarpaulin	Chloroprene	Conex
Heat proof	80°C	130°C	200°C

Notes) • Remember that the heat proof field in the table above shows the allowable temperatures for the boots, not for the cylinder.

- The boots have been mounted at our factory prior to delivery.
- Conex is the registered trademark of Teijin Limited.

### Dimension W

Rod B	Nylon tarpaulin	Chloroprene	Conex
φ63 to φ100	1/4 stroke+X	1/3 stroke+X	1/3 stroke+X
φ125 to φ160	1/5 stroke+X	1/3.5 stroke+X	1/4 stroke+X

### Rod A

Rod A	Nylon tarpaulin	Chloroprene	Conex
φ63-φ80	1/4 stroke+X	1/3 stroke+X	1/3 stroke+X
φ100 to φ160	1/5 stroke+X	1/3.5 stroke+X	1/4 stroke+X

- If the calculated value has a fractional part, round it up.

### Dimensional Table

Symbol Bore	Rod B							Rod A								
	A	B	KK	MM	S	SL	VD	W	A	B	KK	MM	S	SL	VD	W
φ63	35	φ55	M30×1.5	φ36	30	16	15	43	45	φ65	M39×1.5	φ45	41	20	19	43
φ80	45	φ65	M39×1.5	φ45	41	20	12	48	55	φ80	M48×1.5	φ56	50	23	19	48
φ100	55	φ80	M48×1.5	φ56	50	23	15	53	75	φ95	M64×2	φ70	65	27	19	53
φ125	75	φ95	M64×2	φ70	65	27	19	60	90	φ120	M80×2	φ90	-	-	28	60
φ140	80	φ105	M72×2	φ80	75	31	15	60	105	φ130	M95×2	φ100	-	-	24	60
φ160	90	φ120	M80×2	φ90	85	33	15	60	110	φ140	M100×2	φ110	-	-	24	60

Symbol Bore	AE	DD	DE	E	EE	FB	FE	FF	FP	HL	MF	PJ	R	TF
φ63	14	M14×1.5	φ30	□94	Rc1/2	φ18	98	G1/2	47	174	24	109	65	132
φ80	16	M16×1.5	φ36.9	□114	Rc3/4	φ18	125	G3/4	57	202	24	125	87	155
φ100	16	M18×1.5	φ36.9	□135	Rc3/4	φ22	150	G3/4	61	213	31	132	109	190
φ125	18	M22×1.5	φ46.1	□165	Rc1	φ26	175	G1	73	248	37	150	130	224
φ140	18	M27×2	φ46.1	□192	Rc1	φ30	195	G1	81	266	41	160	145	250
φ160	18	M30×2	φ46.1	□218	Rc1	φ33	225	G1	86	290	46	179	170	285

Symbol Bore	UF	ZF
φ63	165	241
φ80	190	274
φ100	230	297
φ125	272	345
φ140	300	367
φ160	345	396

### With Boots

Symbol Bore	Rod B		Rod A	
	WW	X	WW	X
φ63	φ71	55	φ80	55
φ80	φ80	55	φ100	55
φ100	φ100	55	φ125	65
φ125	φ125	65	φ140	65
φ140	φ125	65	φ160	65
φ160	φ140	65	φ180	65

CAD/DATA 140L-1/THL1 Bore A, B is available.

### CA

140L-1 2 CA Bore B B Stroke

Rod dia.	OF	DF	HF
φ90	φ89.5	φ12	28
φ100	φ99.5	φ12	28
φ110	φ109.5	φ15	30

Note) The diameter of the rod B of 160 mm bore cylinder is 90 mm, but it is the width across flats.

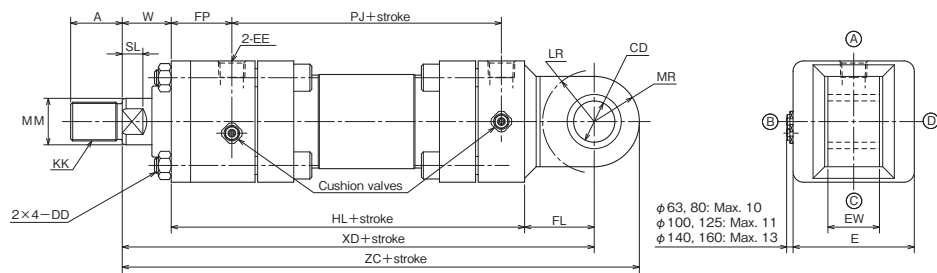
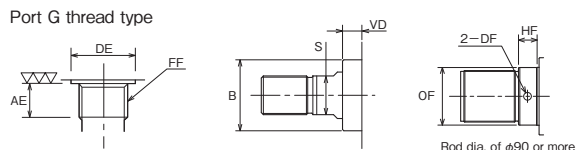

- The positions of cushion valves depend on the cylinder bore.
- For the thread length (dimension A) when the lock nut is used, refer to "Lock nut".
- If you want to change the rod protrusion length, specify dimension W.

### With Boots

140L-1/THL1 Bore K

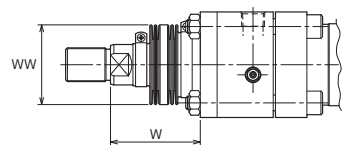

	Standard	Semi-standard	
Material	Nylon tarpaulin	Chloroprene	Conex
Heat proof	80°C	130°C	200°C

- Notes) • Remember that the heat proof field in the table above shows the allowable temperatures for the boots, not for the cylinder.
- The boots have been mounted at our factory prior to delivery.
  - Conex is the registered trademark of Teijin Limited.

### Dimension W

Rod B

Nylon tarpaulin	(φ63 to φ100 1/4 stroke+X)
Chloroprene	(φ125 to φ160 1/5 stroke+X)
Conex	(φ63 to φ100 1/3 stroke+X)
	(φ125·φ140 1/3.5 stroke+X)
	(φ160 1/4 stroke+X)

- If the calculated value has a fractional part, round it up.

### Rod A

Nylon tarpaulin	(φ63·φ80 1/4 stroke+X)
Chloroprene	(φ100 to φ160 1/5 stroke+X)
Conex	(φ63·φ80 1/3 stroke+X)
	(φ100 1/3.5 stroke+X)
	(φ125 to φ160 1/4 stroke+X)

### Dimensional Table

Symbol Bore	Rod B							Rod A								
	A	B	KK	MM	S	SL	VD	W	A	B	KK	MM	S	SL	VD	W
φ63	35	φ55	M30×1.5	φ36	30	16	15	43	45	φ65	M39×1.5	φ45	41	20	19	43
φ80	45	φ65	M39×1.5	φ45	41	20	12	48	55	φ80	M48×1.5	φ56	50	23	19	48
φ100	55	φ80	M48×1.5	φ56	50	23	15	53	75	φ95	M64×2	φ70	65	27	19	53
φ125	75	φ95	M64×2	φ70	65	27	19	60	90	φ120	M80×2	φ90	-	-	28	60
φ140	80	φ105	M72×2	φ80	75	31	15	60	105	φ130	M95×2	φ100	-	-	24	60
φ160	90	φ120	M80×2	φ90	85	33	15	60	110	φ140	M100×2	φ110	-	-	24	60

Symbol Bore	AE	CD	DD	DE	E	EE	EW	FF	FL	FP	HL	LR	MR	PJ
φ63	14	φ32H10	M14×1.5	φ30	□94	Rc1/2	40 <sup>-0.1</sup> <sub>-0.4</sub>	G1/2	54	47	174	R40	R35	109
φ80	16	φ40H10	M16×1.5	φ36.9	□114	Rc3/4	50 <sup>-0.1</sup> <sub>-0.4</sub>	G3/4	66	57	202	R50	R40	125
φ100	16	φ50H10	M18×1.5	φ36.9	□135	Rc3/4	63 <sup>-0.1</sup> <sub>-0.4</sub>	G3/4	79	61	213	R63	R50	132
φ125	18	φ63H10	M22×1.5	φ46.1	□165	Rc1	80 <sup>-0.1</sup> <sub>-0.6</sub>	G1	90	73	248	R71	R63	150
φ140	18	φ70H10	M27×2	φ46.1	□192	Rc1	90 <sup>-0.1</sup> <sub>-0.6</sub>	G1	99	81	266	R80	R70	160
φ160	18	φ80H10	M30×2	φ46.1	□218	Rc1	100 <sup>-0.1</sup> <sub>-0.6</sub>	G1	110	86	290	R90	R80	179

Symbol Bore	XD	ZC
φ63	271	306
φ80	316	356
φ100	345	395
φ125	398	461
φ140	425	495
φ160	460	540

### With Boots

Symbol Bore	Rod B		Rod A	
	WW	X	WW	X
φ63	φ71	55	φ80	55
φ80	φ80	55	φ100	55
φ100	φ100	55	φ125	65
φ125	φ125	65	φ140	65
φ140	φ125	65	φ160	65
φ160	φ140	65	φ180	65



CAD/DATA 140L-1/THL1 [Bore] A, B is available.

### CB

140L-1 [2] CB [Bore] B B Stroke

Port G thread type

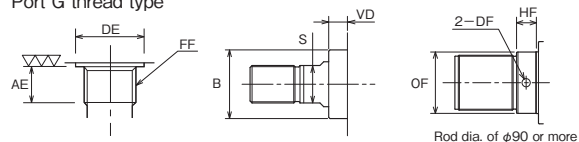

Rod dia.	OF	DF	HF
φ90	φ89.5	φ12	28
φ100	φ99.5	φ12	28
φ110	φ109.5	φ15	30

Note) The diameter of the rod B of 160 mm bore cylinder is 90 mm, but it is the width across flats.

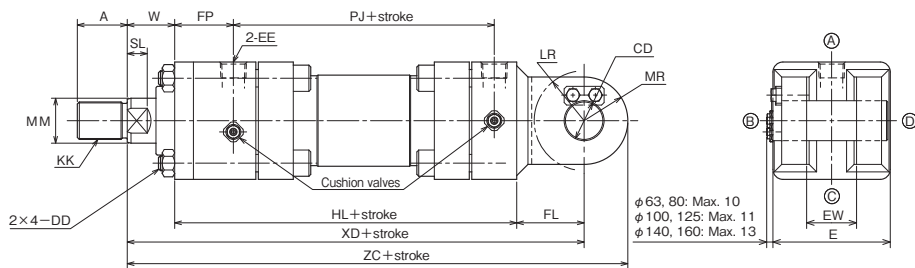

φ63, 80: Max. 10  
φ100, 125: Max. 11  
φ140, 160: Max. 13

- The positions of cushion valves depend on the cylinder bore.
- For the thread length (dimension A) when the lock nut is used, refer to "Lock nut".
- If you want to change the rod protrusion length, specify dimension W.

### With Boots

140L-1/THL1 [Bore] K

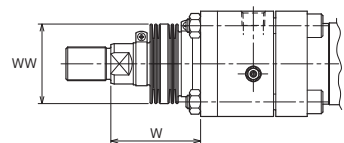

	Standard	Semi-standard	
Material	Nylon tarpaulin	Chloroprene	Conex
Heat proof	80°C	130°C	200°C

- Notes) • Remember that the heat proof field in the table above shows the allowable temperatures for the boots, not for the cylinder.
- The boots have been mounted at our factory prior to delivery.
  - Conex is the registered trademark of Teijin Limited.

### Dimension W

Rod B	Nylon tarpaulin	Chloroprene	Conex
φ63 to φ100	1/4 stroke+X	1/3 stroke+X	1/3 stroke+X
φ125 to φ160	1/5 stroke+X	1/3.5 stroke+X	1/4 stroke+X

Rod A	Nylon tarpaulin	Chloroprene	Conex
φ63·φ80	1/4 stroke+X	1/3 stroke+X	1/3 stroke+X
φ100 to φ160	1/5 stroke+X	1/3.5 stroke+X	1/4 stroke+X

- If the calculated value has a fractional part, round it up.

### Dimensional Table

Symbol	Rod B							Rod A								
	A	B	KK	MM	S	SL	VD	W	A	B	KK	MM	S	SL	VD	W
φ63	35	φ55	M30×1.5	φ36	30	16	15	43	45	φ65	M39×1.5	φ45	41	20	19	43
φ80	45	φ65	M39×1.5	φ45	41	20	12	48	55	φ80	M48×1.5	φ56	50	23	19	48
φ100	55	φ80	M48×1.5	φ56	50	23	15	53	75	φ95	M64×2	φ70	65	27	19	53
φ125	75	φ95	M64×2	φ70	65	27	19	60	90	φ120	M80×2	φ90	-	-	28	60
φ140	80	φ105	M72×2	φ80	75	31	15	60	105	φ130	M95×2	φ100	-	-	24	60
φ160	90	φ120	M80×2	φ90	85	33	15	60	110	φ140	M100×2	φ110	-	-	24	60

Symbol	AE	CD	DD	DE	E	EE	EW	FF	FL	FP	HL	LR	MR	PJ
φ63	14	φ32 <sup>H10</sup> / <sub>F8</sub>	M14×1.5	φ30	□94	Rc1/2	40 <sup>+0.4</sup> / <sub>+0.1</sub>	G1/2	54	47	174	R40	R35	109
φ80	16	φ40 <sup>H10</sup> / <sub>F8</sub>	M16×1.5	φ36.9	□114	Rc3/4	50 <sup>+0.4</sup> / <sub>+0.1</sub>	G3/4	66	57	202	R50	R40	125
φ100	16	φ50 <sup>H10</sup> / <sub>F8</sub>	M18×1.5	φ36.9	□135	Rc3/4	63 <sup>+0.4</sup> / <sub>+0.1</sub>	G3/4	79	61	213	R63	R50	132
φ125	18	φ63 <sup>H10</sup> / <sub>F8</sub>	M22×1.5	φ46.1	□165	Rc1	80 <sup>+0.6</sup> / <sub>+0.1</sub>	G1	90	73	248	R71	R63	150
φ140	18	φ70 <sup>H10</sup> / <sub>F8</sub>	M27×2	φ46.1	□192	Rc1	90 <sup>+0.6</sup> / <sub>+0.1</sub>	G1	99	81	266	R80	R70	160
φ160	18	φ80 <sup>H10</sup> / <sub>F8</sub>	M30×2	φ46.1	□218	Rc1	100 <sup>+0.6</sup> / <sub>+0.1</sub>	G1	110	86	290	R90	R80	179

Symbol	XD	ZC
φ63	271	306
φ80	316	356
φ100	345	395
φ125	398	461
φ140	425	495
φ160	460	540

### With Boots

Symbol	Rod B		Rod A	
	WW	X	WW	X
φ63	φ71	55	φ80	55
φ80	φ80	55	φ100	55
φ100	φ100	55	φ125	65
φ125	φ125	65	φ140	65
φ140	φ125	65	φ160	65
φ160	φ140	65	φ180	65

CAD/DATA 140L-1/THL1 [Bore] A, B is available.

### TA

140L-1 [2] TA [Bore] [B] [Stroke]

Port G thread type

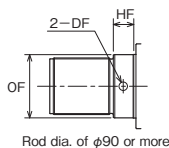
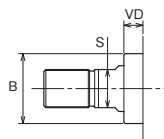
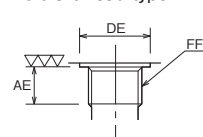

Rod dia.	OF	DF	HF
φ90	φ89.5	φ12	28
φ100	φ99.5	φ12	28
φ110	φ109.5	φ15	30

Note) The diameter of the rod B of 160 mm bore cylinder is 90 mm, but it is the width across flats.

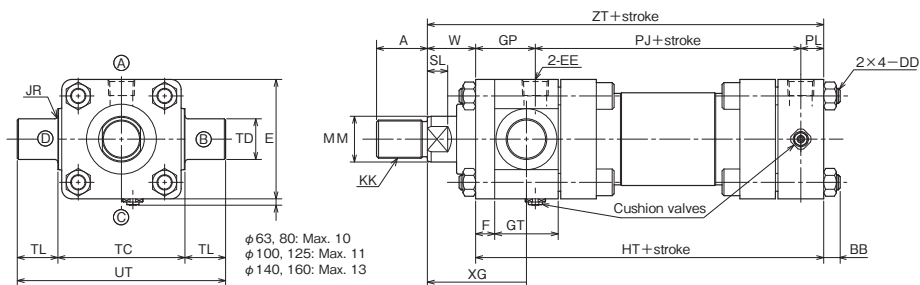

φ 63, 80: Max. 10  
φ 100, 125: Max. 11  
φ 140, 160: Max. 13

- The positions of cushion valves depend on the cylinder bore.
- For the thread length (dimension A) when the lock nut is used, refer to "Lock nut".
- If you want to change the rod protrusion length, specify dimension W.

### With Boots

140L-1/THL1 [Bore] K

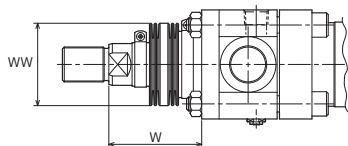

	Standard	Semi-standard	
Material	Nylon tarpaulin	Chloroprene	Conex
Heat proof	80°C	130°C	200°C

- Notes) • Remember that the heat proof field in the table above shows the allowable temperatures for the boots, not for the cylinder.
- The boots have been mounted at our factory prior to delivery.
  - Conex is the registered trademark of Teijin Limited.

### Dimension W

Rod B	Nylon tarpaulin	Chloroprene	Conex
φ63 to φ100	1/4 stroke+X	1/5 stroke+X	1/3 stroke+X
φ125 to φ160	1/5 stroke+X	1/3.5 stroke+X	1/4 stroke+X

### Rod A

Rod A	Nylon tarpaulin	Chloroprene	Conex
φ63·φ80	1/4 stroke+X	1/3 stroke+X	1/3.5 stroke+X
φ100 to φ160	1/5 stroke+X	1/4 stroke+X	1/4 stroke+X

- If the calculated value has a fractional part, round it up.

### Dimensional Table

Symbol Bore	Rod B							Rod A								
	A	B	KK	MM	S	SL	VD	W	A	B	KK	MM	S	SL	VD	W
φ63	35	φ55	M30×1.5	φ36	30	16	15	43	45	φ65	M39×1.5	φ45	41	20	19	43
φ80	45	φ65	M39×1.5	φ45	41	20	12	48	55	φ80	M48×1.5	φ56	50	23	19	48
φ100	55	φ80	M48×1.5	φ56	50	23	15	53	75	φ95	M64×2	φ70	65	27	19	53
φ125	75	φ95	M64×2	φ70	65	27	19	60	90	φ120	M80×2	φ90	-	-	28	60
φ140	80	φ105	M72×2	φ80	75	31	15	60	105	φ130	M95×2	φ100	-	-	24	60
φ160	90	φ120	M80×2	φ90	85	33	15	60	110	φ140	M100×2	φ110	-	-	24	60

Symbol Bore	AE	BB	DD	DE	E	EE	F	FF	GP	GT	HT	JR	PJ	PL	TC
φ63	14	15 or less	M14×1.5	φ30	□94	Rc1/2	15	G1/2	47	50	174	R2.5	109	18	100 <sup>0</sup> <sub>-0.35</sub>
φ80	16	19 or less	M16×1.5	φ36.9	□114	Rc3/4	18	G3/4	57	60	202	R3	125	20	125 <sup>0</sup> <sub>-0.4</sub>
φ100	16	19 or less	M18×1.5	φ36.9	□135	Rc3/4	22	G3/4	66	65	218	R3	132	20	155 <sup>0</sup> <sub>-0.4</sub>
φ125	18	24 or less	M22×1.5	φ46.1	□165	Rc1	24	G1	73	75	248	R4	150	25	195 <sup>0</sup> <sub>-0.46</sub>
φ140	18	25 or less	M27×2	φ46.1	□192	Rc1	32	G1	86	80	271	R4	160	25	220 <sup>0</sup> <sub>-0.46</sub>
φ160	18	30 or less	M30×2	φ46.1	□218	Rc1	37	G1	111	100	315	R4	179	25	240 <sup>0</sup> <sub>-0.46</sub>

Symbol Bore	TD	TL	UT	XG	ZT
φ63	φ32e9	32	164	83	217
φ80	φ40e9	40	205	96	250
φ100	φ50e9	50	255	107	271
φ125	φ63e9	63	321	122	308
φ140	φ70e9	70	360	132	331
φ160	φ80e9	80	400	147	375

### With Boots

Symbol Bore	Rod B		Rod A	
	WW	X	WW	X
φ63	φ71	55	φ80	55
φ80	φ80	55	φ100	55
φ100	φ100	55	φ125	65
φ125	φ125	65	φ140	65
φ140	φ125	65	φ160	65
φ160	φ140	65	φ180	65



140L-1/THL1 Bore A, B is available.

### TC

140L-1 2 TC Bore B B Stroke

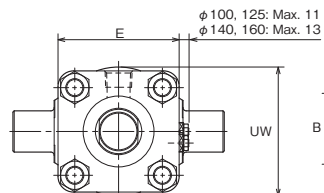

• Bore φ100 to φ160

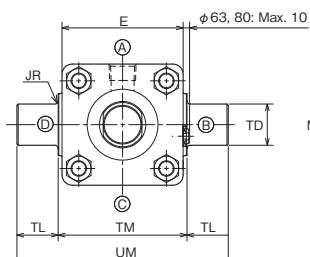

• Bore φ63, φ80

- The positions of cushion valves depend on the cylinder bore.
- If the stroke is short or dimension PH is small, pay attention to the cushion valve position.
- For the thread length (dimension A) when the lock nut is used, refer to "Lock nut".

Port G thread type

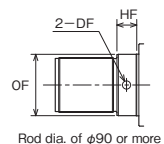
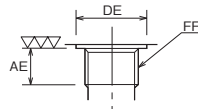

Rod dia.	OF	DF	HF
φ90	φ89.5	φ12	28
φ100	φ99.5	φ12	28
φ110	φ109.5	φ15	30

Note) The diameter of the rod B of 160 mm bore cylinder is 90 mm, but it is the width across flats.

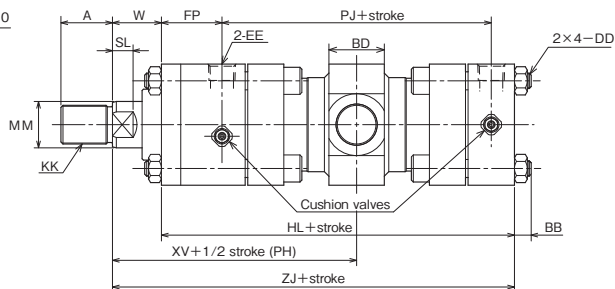

- If you want to change the rod protrusion length, specify dimension W.

### With Boots

140L-1/THL1 Bore K

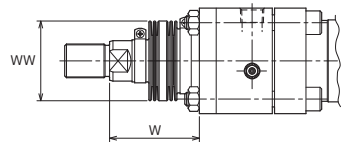

	Standard	Semi-standard	
Material	Nylon tarpaulin	Chloroprene	Conex
Heat proof	80°C	130°C	200°C

- Notes) • Remember that the heat proof field in the table above shows the allowable temperatures for the boots, not for the cylinder.
- The boots have been mounted at our factory prior to delivery.
  - Conex is the registered trademark of Teijin Limited.

### Dimension W

Rod B

Nylon tarpaulin	(φ63 to φ100	1/4	stroke+X)
Chloroprene	(φ125 to φ160	1/5	stroke+X)
Conex	(φ63 to φ100	1/3	stroke+X)
	(φ125·φ140	1/3.5	stroke+X)
	(φ160	1/4	stroke+X)

- If the calculated value has a fractional part, round it up.

### Rod A

Nylon tarpaulin	(φ63·φ80	1/4	stroke+X)
Chloroprene	(φ100 to φ160	1/5	stroke+X)
Conex	(φ63·φ80	1/3	stroke+X)
	(φ100	1/3.5	stroke+X)
	(φ125 to φ160	1/4	stroke+X)

### Dimensional Table

Symbol Bore	Rod B							Rod A								
	A	B	KK	MM	S	SL	VD	W	A	B	KK	MM	S	SL	VD	W
φ63	35	φ55	M30×1.5	φ36	30	16	15	43	45	φ65	M39×1.5	φ45	41	20	19	43
φ80	45	φ65	M39×1.5	φ45	41	20	12	48	55	φ80	M48×1.5	φ56	50	23	19	48
φ100	55	φ80	M48×1.5	φ56	50	23	15	53	75	φ95	M64×2	φ70	65	27	19	53
φ125	75	φ95	M64×2	φ70	65	27	19	60	90	φ120	M80×2	φ90	-	-	28	60
φ140	80	φ105	M72×2	φ80	75	31	15	60	105	φ130	M95×2	φ100	-	-	24	60
φ160	90	φ120	M80×2	φ90	85	33	15	60	110	φ140	M100×2	φ110	-	-	24	60

Symbol Bore	AE	BB	BD	DD	DE	E	EE	FF	FP	HL	JR	Min. PH	PJ	TM
φ63	14	15 or less	43	M14×1.5	φ30	□94	Rc1/2	G1/2	47	174	R2.5	185	109	100 <sup>0</sup> <sub>-0.35</sub>
φ80	16	19 or less	53	M16×1.5	φ36.9	□114	Rc3/4	G3/4	57	202	R3	215	125	125 <sup>0</sup> <sub>-0.4</sub>
φ100	16	19 or less	63	M18×1.5	φ36.9	□135	Rc3/4	G3/4	61	213	R3	240	132	155 <sup>0</sup> <sub>-0.4</sub>
φ125	18	24 or less	78	M22×1.5	φ46.1	□165	Rc1	G1	73	248	R4	285	150	195 <sup>0</sup> <sub>-0.46</sub>
φ140	18	25 or less	88	M27×2	φ46.1	□192	Rc1	G1	81	266	R4	309	160	220 <sup>0</sup> <sub>-0.46</sub>
φ160	18	30 or less	98	M30×2	φ46.1	□218	Rc1	G1	86	290	R4	327	179	240 <sup>0</sup> <sub>-0.46</sub>

Symbol Bore	TD	TL	UM	UW	XV	ZJ
φ63	φ32e9	32	164	-	144.5	217
φ80	φ40e9	40	205	-	167.5	250
φ100	φ50e9	50	255	146	180	266
φ125	φ63e9	63	321	185	208	308
φ140	φ70e9	70	360	210	221	326
φ160	φ80e9	80	400	230	235.5	350

### With Boots

Symbol Bore	Rod B		Rod A	
	WW	X	WW	X
φ63	φ71	55	φ80	55
φ80	φ80	55	φ100	55
φ100	φ100	55	φ125	65
φ125	φ125	65	φ140	65
φ140	φ125	65	φ160	65
φ160	φ140	65	φ180	65

CAD/DATA 140L-1/THL1 [Bore] A, B is available.

### Rod End Attachment

#### ● Rod eye (T-end)

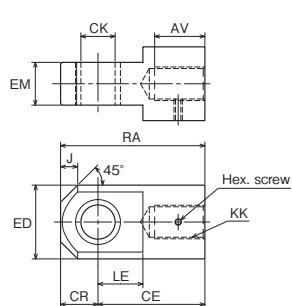

#### ● Rod clevis (Y-end) with pin

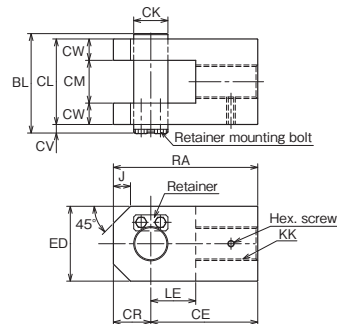

● If the rod A is used, change the rod end thread diameter to that of the rod B.

#### ● Delivery of rod end attachment (T-end or Y-end)

① When the lock nut and rod end attachment are additionally ordered  
The rod end attachment and lock nut are temporarily assembled to the piston rod for delivery. Since the lock nut is not tightened, tighten it after adjusting the position of the rod end attachment. No hex. screw is supplied.

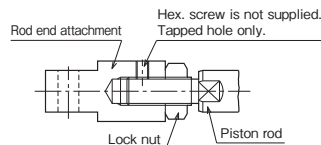

② When only the rod end attachment is additionally ordered (without lock nut)  
The rod end attachment is tightened to the piston rod, and a drill hole is made on the piston rod for delivery.

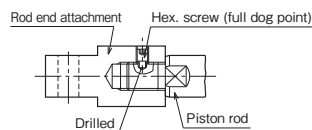

If the drill hole is unnecessary, give us such instructions.

#### ● Lock nut

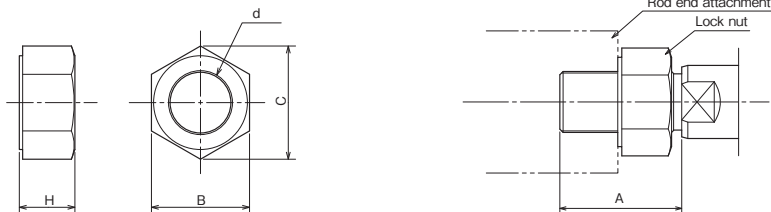

The standard fitting length of the rod end attachment and piston rod is about 80% of the thread diameter. Therefore, if you order a cylinder with a lock nut, dimension A is longer.

### Dimensional Table: Rod eye (T-end)

Symbol	Rod B										
	Part number	AV	CE	CK	CR	ED	EM	J	KK	LE	RA
φ63	RTH-30-2-H	40	95	φ32H10	35	φ70	40 <sup>-0.1</sup> <sub>-0.4</sub>	16	M30×1.5	42	130
φ80	RTH-39-2-H	53	110	φ40H10	40	φ80	50 <sup>-0.1</sup> <sub>-0.4</sub>	15	M39×1.5	52	150
φ100	RTH-48-2-H	62	135	φ50H10	50	φ98	63 <sup>-0.1</sup> <sub>-0.4</sub>	20	M48×1.5	65	185
φ125	RTH-64-3-H	80	160	φ63H10	63	φ118	80 <sup>-0.1</sup> <sub>-0.6</sub>	30	M64×2	75	223
φ140	RTH-72-3-H	87	180	φ70H10	70	φ138	90 <sup>-0.1</sup> <sub>-0.6</sub>	35	M72×2	82	250
φ160	RTH-80-3-H	96	195	φ80H10	80	φ158	100 <sup>-0.1</sup> <sub>-0.6</sub>	40	M80×2	94	275

### Dimensional Table: Rod clevis (Y-end) with pin

Symbol	Rod B													
	Part number	BL	CE	CK	CL	CM	CR	CV	CW	ED	J	KK	LE	RA
φ63	RYH-30-1-H	93	95	φ32 <sup>H10</sup> <sub>FB</sub>	80	40 <sup>+0.4</sup> <sub>+0.1</sub>	35	8	20	70	16	M30×1.5	42	130
φ80	RYH-39-2-H	117	110	φ40 <sup>H10</sup> <sub>FB</sub>	100	50 <sup>+0.4</sup> <sub>+0.1</sub>	40	12	25	80	15	M39×1.5	52	150
φ100	RYH-48-2-H	143	135	φ50 <sup>H10</sup> <sub>FB</sub>	126	63 <sup>+0.4</sup> <sub>+0.1</sub>	50	12	31.5	100	20	M48×1.5	65	185
φ125	RYH-64-3-H	183	160	φ63 <sup>H10</sup> <sub>FB</sub>	160	80 <sup>+0.6</sup> <sub>+0.1</sub>	63	18	40	120	30	M64×2	75	223
φ140	RYH-72-3-H	203	180	φ70 <sup>H10</sup> <sub>FB</sub>	180	90 <sup>+0.6</sup> <sub>+0.1</sub>	70	18	45	140	35	M72×2	82	250
φ160	RYH-80-3-H	223	195	φ80 <sup>H10</sup> <sub>FB</sub>	200	100 <sup>+0.6</sup> <sub>+0.1</sub>	80	18	50	160	40	M80×2	94	275

Notes) ● The rod end attachments are dedicated to the rod B. When the rod A is used, change the rod end thread diameter to that of the rod B.

● To use the rod end attachment and lock nut on the rod A, give instructions to change the piston rod end thread length to the long size for the rod B.

### Dimensional Table: Dimension A when lock nut is used (long thread)

Symbol	Rod B		Rod A	
	A	KK	A	KK
φ63	60	M30×1.5	80	M39×1.5
φ80	80	M39×1.5	95	M48×1.5
φ100	95	M48×1.5	125	M64×2
φ125	125	M64×2	155	M80×2
φ140	140	M72×2	185	M95×2
φ160	155	M80×2	190	M100×2

### Dimensional Table: Lock nut

Symbol	Rod B					Rod A				
	Part number	B	C	d	H	Part number	B	C	d	H
φ63	LNH-30F-1-H	46	53.1	M30×1.5	25	LNH-39F-1-H	60	69.3	M39×1.5	32
φ80	LNH-39F-1-H	60	69.3	M39×1.5	32	LNH-48F-1-H	75	86.6	M48×1.5	38
φ100	LNH-48F-1-H	75	86.6	M48×1.5	38	LNH-64F-1-H	95	109.7	M64×2	51
φ125	LNH-64F-1-H	95	109.7	M64×2	51	LNH-80F-1-H	115	132.8	M80×2	64
φ140	LNH-72F-1-H	105	121.2	M72×2	58	LNH-95F-1-H	135	155.9	M95×2	76
φ160	LNH-80F-1-H	115	132.8	M80×2	64	LNH-100F-1-H	145	167.4	M100×2	80

## Notes on installation

## ● Stationary body mounting

The direction of the movement of the article to be moved by the cylinder must be aligned with the center of the axis of motion of the piston rod. If the direction deviates from the center of the axis, the bush will wear earlier, and the cylinder tube will weld and scoring. To check for misalignment, when installing the cylinder, measure the misalignment of the article setting position from the rod at the positions where the piston rod is fully retracted and advanced, and completely center the setting position. After this, connect the cylinder and the article. In the trial operation, run the cylinder at as low speed as possible to make sure that the cylinder moves smoothly. Sufficiently check the connecting part between cylinder and article.

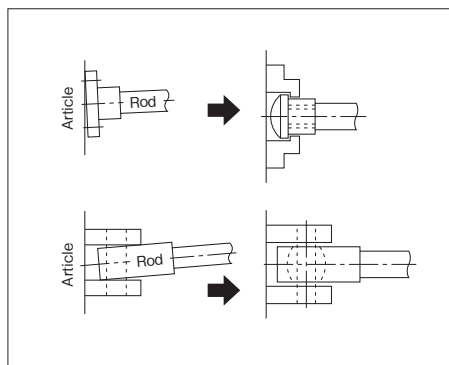

Note) The rigidity of the mounting elements of the stationary cylinder body greatly affects the cylinder performance. Accordingly, if the mounting elements have insufficient rigidity, they will be distorted by the cylinder thrust force, the piston rod and bush will be deformed and worn earlier, and the piston rod threads may be damaged. Use rigid mounting elements.

## 1. LA style

The LA style cylinder is secured with L-shaped clamp bolts. However, this is not perfect for movement in the axial direction under load. Therefore, install a stopper on the mounting base side.

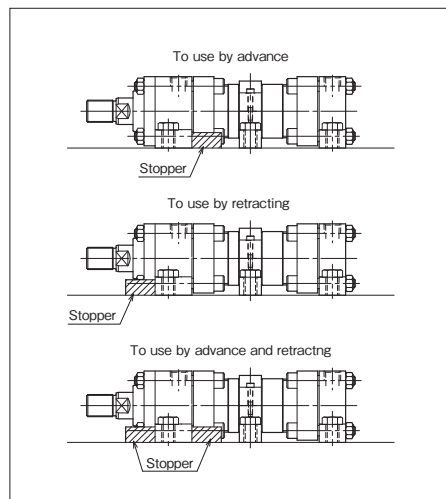

## 2. FA/FB style

- When the cylinder is used by advance upward the perpendicularly installed rod to move a long article, check the calculated buckling value.
- When the cylinder installed horizontally is used by advance to move a long article, check the calculated buckling value, and take into consideration the bending due to its own weight.

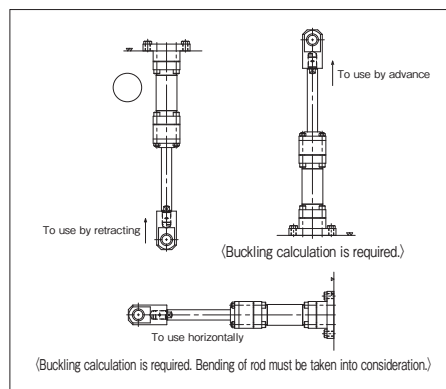

## ● Swing mounting

For a cylinder which is movable in a plane, connect the rod end connecting accessory with a pin so that the cylinder can move in the plane. In the direction perpendicular to the plane, carefully check for alignment in the same manner as for the stationary body mounting. Use a pin with a size shown in the catalog.

- When the cylinder is used by advance upward the perpendicularly installed rod to move a long article, check the calculated buckling value.
- When the cylinder installed horizontally is used by advance to move a long stroke, check the calculated buckling value, and take into consideration the bending due to its own weight. Be sure to apply a lubricant to the bearing of the connecting accessory.

## 1. CA/CB style

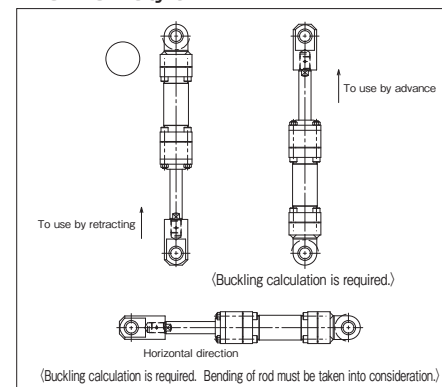

## 2. TA/TC style

## ● Mounting of trunnion bearing

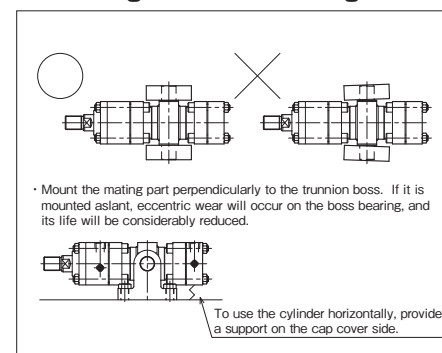

## Notes on using rod A

Since a cylinder with the rod A has a smaller pressure receiving area on the rod side, and the pressure in the cylinder can easily increase, take sufficient care to prevent the pressure from exceeding the maximum allowable pressure.

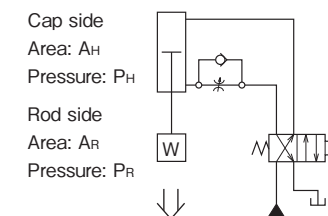

## &lt;Example&gt;

Find the pressure on the rod side when the cylinder is advanced (downward) under the following conditions.

Cylinder: 140L-1,  $\phi 80$ , rod A  
Load:  $W=1000 \text{ kg}$  ( $\approx 10000 \text{ N}$ )  
Set pressure:  $P_H=8 \text{ MPa}$   
Installation direction: Rod facing downward  
Speed control: Meter-out  
The operating speed is low, and the load rate is 100%.

## &lt;Answer&gt;

The pressure  $P_R$  generated on the rod side is the sum of the pressure  $P_1$  generated to balance with the load  $W$  and the pressure  $P_2$  boosted up by the supply from the cap side.

- Pressure  $P_1$  generated to balance with the load

$$P_1 = \frac{W}{A_R} = \frac{10000(\text{N})}{2564(\text{mm}^2)} = 3.9(\text{MPa})$$

- Pressure  $P_2$  boosted up by the supply from the cap side

$$\text{Where, } P_2 A_R = P_H A_H$$

$$P_2 = \frac{P_H A_H}{A_R} = \frac{8(\text{MPa}) \times 5027(\text{mm}^2)}{2564(\text{mm}^2)} = 15.7(\text{MPa})$$

- Pressure  $P_R$  generated on the rod side

$$P_R = P_1 + P_2 = 3.9 + 15.7 = 19.6(\text{MPa})$$

∴ The pressure exceeds the maximum allowable pressure on the rod side for the 140L-1 rod A type cylinder, 18 MPa, shown in the standard specifications. Therefore, the cylinder is unusable. Recalculate after changing the conditions.