



# 70/140H-8



## Standard built-in high-performance cushion in hydraulic cylinders

- Double acting hydraulic cylinders for 7/14 MPa with a bore from  $\phi 32$  to  $\phi 250$ .
- The adoption of high-performance cushion has reduced a shock at stopping.
- The adoption of newly designed cushion valve allows easy cushion adjustment.
- The anti-coming-off structure and looseness-preventive lock nut have been adopted as safety measures for the cushion valve.
- Standardized new-type small switch in varieties with the improved maintenance.



### Standard specifications

Types	Specifications of general purpose and cutting fluid proof types	
	7MPa	14MPa
Nominal pressure	7MPa	14MPa
Maximum allowable pressure	Head side: 9MPa Rod side : (A)15MPa (B)13.5MPa (C)11MPa	Head side: 18MPa Rod side : (A)18MPa (B)18MPa (C)14MPa
Proof test pressure	10.5MPa	21MPa
Minimum working pressure	Head side: 0.3MPa or less Rod side : (A)0.6MPa or less (B)0.45MPa or less (C)0.4MPa or less	
Operating speed range	$\phi 32\text{-}\phi 63$ : 8-400mm/s $\phi 80\text{-}\phi 125$ : 8-300mm/s $\phi 140\text{-}\phi 250$ : 8-200mm/s	
Temperature range (Ambient temperature and oil temperature)	Standard type ..... -10 - +80°C (Notes) Switch set AX type ..... -10 - +70°C WR•WS type ..... -10 - +60°C (at non-freezing condition)	
Structure of cushioning	Metal fitting type	
Adaptable working oil	Petroleum-based fluid (For other working oil, refer to the table of working oil adaptability)	
Tolerance of thread	JIS 6g/6H (JIS grade 2 or equivalence)	
Tolerance of stroke	100mm or lower ${}^{+0.8}_0$ 101- 250mm ${}^{+1.0}_0$ 251- 630mm ${}^{+1.25}_0$ 631-1000mm ${}^{+1.4}_0$ 1001-1600mm ${}^{+1.6}_0$ 1601-2000mm ${}^{+1.8}_0$	
Tube material	Standard type ..... • carbon steel for machine structural use Switch set ..... • stainless	
Mounting type	SD•LA•LB•LC•FA•FB•FC•FD•FK• FE•FY•FZ•CA•CB•CS•TA•TC	SD•LA•LC•FC•FD•FE•FK• FY•FZ•CA•CB•CS•TA•TC
Accessories	<ul style="list-style-type: none"> <li>• Rod end eye (T-end), Eye joint with spherical bearing (S-end) , rod end clevis (Y-end) with pin, lock nut</li> <li>• Floating joint (F-end) : only 7 MPa type</li> <li>• Boots : only general purpose type Standard: nylon tarpaulin Semi-standard: chloroprene, Conex</li> </ul>	

### Terminologies

#### Nominal pressure

The maximum set pressure of a relief valve in a hydraulic circuit in which a cylinder is used.

#### Maximum allowable pressure

The maximum allowable pressure generated in a cylinder (surge pressure, etc.)

#### Proof test pressure

Test pressure against which a cylinder can withstand without unreliability performance at the return to nominal pressure.

#### Minimum working pressure

The minimum pressure that the cylinder placed horizontally without a load can work.

#### Notes

- The hydraulic pressure generated in a cylinder due to the inertia of load must be lower than the maximum allowable pressure.
- The working temperature range depends on the material of packings. For details, refer to the selection materials in the beginning of this catalogue.
- In case that the lock nut is attached to the piston rod end thread part, lengthen the thread length (dimension A).
- The cylinder with a bore of  $\phi 150$  mm does not conform to JIS standards.
- The types in ( ) marks in the mounting style column are applicable to the nominal pressure of 7MPa. It is basically impossible to use them with the pressure exceeding 7 MPa. For using method, contact us. The FE type is applicable only to the rod A.
- For the internal structure, refer to the sectional drawings in the end of this catalogue.
- Conex, material of the boots, is the trademark of Teijin, Ltd.
- LB mounting and A rod is limited at the bore 125mm.

Lines

Unit: mm

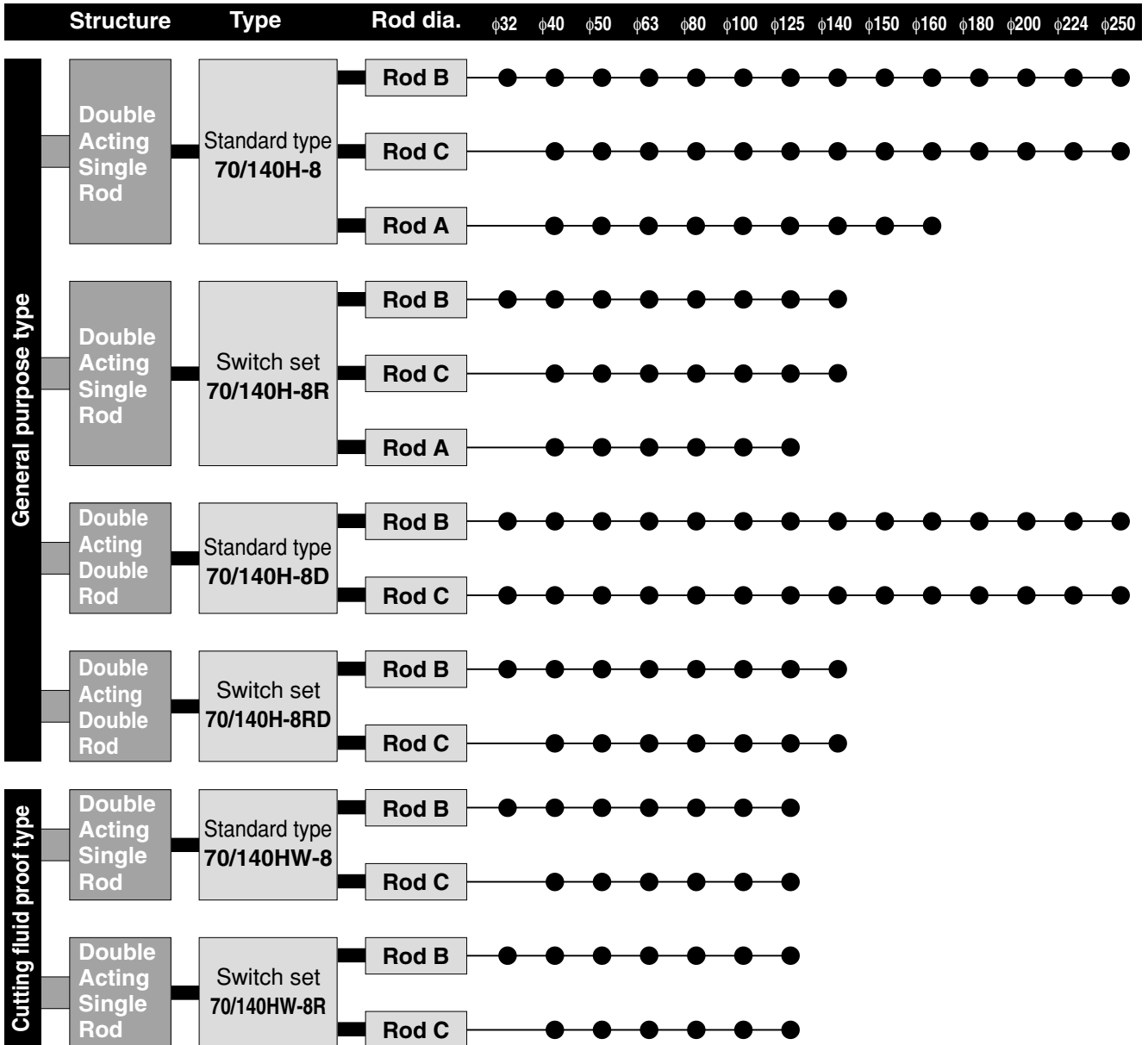

General purpose hydraulic cylinder

- Notes) ● You are requested to select "Switch set" cylinder when you would like to use switches.  
 ● Switches can't be mounted on Standard type.

Stroke fabrication range

Unit: mm

Bore	Standard type	Switch set
φ32 - φ50	- 1200	- 1200
φ63•φ80	- 1600	- 1600
φ100 - φ140	- 2000	- 2000
φ150 - φ250	- 2000	-

- The above strokes indicate the maximum available strokes for the standard type.
- For the rod buckling, check with the buckling chart of the selection materials. If you request the strokes other than in the table above, contact us.

Cushion stroke length

Unit: mm

Bore	Cushion ring length L	Cushion ring parallel part length ℓ
φ32	R side	25
	H side	23
φ40 - φ63	25	7
φ80 - φ125	25	8
φ140 - φ160	30	12
φ180 - φ224	40	20
φ250	45	25

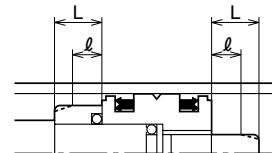

- The cushion stroke lengths in case of cylinders used up to the stroke end.
- In case that cylinders are not used up to the stroke end, and they are stopped 5 mm or more before the stroke end, the cushioning effect will be weakened. In such a case, contact us.

### General purpose type

The items in broken lines in the codes below need not to be entered, if unnecessary.    Semi-standard specification

• **Standard type**

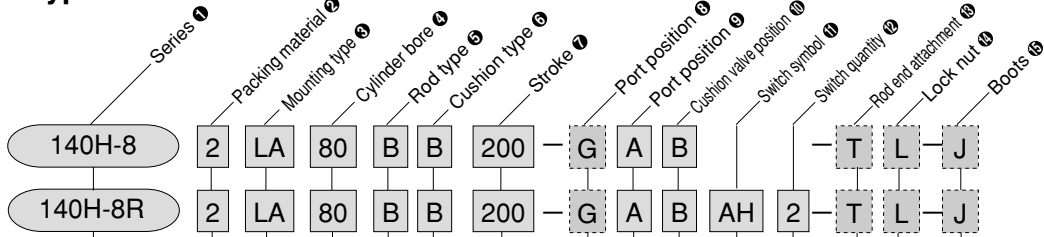

• **Switch set**

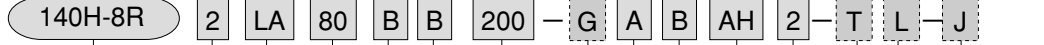

Double Acting Single-Rod

- For 7MPa
  - 70H-8 : Standard type
  - 70H-8R : Switch set
- For 14MPa
  - 140H-8 : Standard type
  - 140H-8R : Switch set

Double Acting Double-Rod

- For 7MPa
  - 70H-8D : Standard type
  - 70H-8RD : Switch set
- For 14MPa
  - 140H-8D : Standard type
  - 140H-8RD : Switch set

- 1 Nitrile rubber (φ32 - φ250)
- 2 Urethane rubber (φ32 - φ160)
- 3 Fluoric rubber (φ32 - φ250)
- 6 Hydrogenated nitrile rubber (φ32 - φ160)
- 8 Slipper seal (φ32 - φ100)

Note) The packing material of the slipper seal, other than the piston packing, is nitrile rubber.

Rod A

- Standard type: (φ40 - φ160)
- Switch set: (φ40 - φ125)

Rod B, C

- Standard type: (φ32 - φ250)
- Switch set: (φ32 - φ140)

Note) The available minimum dia. of the rod C is φ40.

Mounting type

- B with cushions on both ends
- R with cushion on the rod side
- H with cushion on the head side
- N without cushion

- A Rod A
- B Rod B
- C Rod C

Cylinder stroke (mm)

- None Rc thread
- G G thread (Made-to-order)
- N NPT thread (Made-to-order)

**Switch symbol**

Note) Select applicable switches out of the Switch List

**Notes on order for switch sets**

- If a switch is unnecessary, enter the switch symbol ① and the switch quantity ② of 0.
- Switches are not mounted to cylinders at delivery.

- J Nylon tarpaulin
- JN Chloroprene
- JK Conex

L with lock nut

- T T-end (rod end eye)
  - S S-end (Eye joint with spherical bearing)
  - Y Y-end (rod end clevis)
  - F F-end (F-joint) (for 7 MPa)
- Note) For the rod A, contact us.

Switch quantity (1, 2, to n)

Cushion valve position (A, B, C, D, 0)

Port position (A, B, C, D)

### Cutting fluid proof type

• **Standard type**

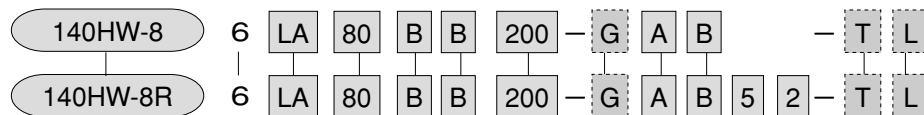

• **Switch set**

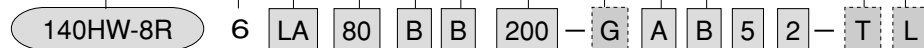

Double Acting Single-Rod

- For 7MPa
  - 70HW-8 : Standard type
  - 70HW-8R : Switch set
- For 14MPa
  - 140HW-8 : Standard type
  - 140HW-8R : Switch set

Cylinder bore (mm)  
φ32 - φ125

Hydrogenated nitrile rubber

- Contact
  - 5 WR 505 (with 5 m cord)
  - 7 WR 505F (with 5 m cord/flex tube attached)
  - 6 WR515 (with 5 m cord/cable type)
- No contact
  - RA AX205W (with 5m cord)
  - RB AZ205W (with 5m cord)
  - 2 WS215 (with 5 m cord)
  - 4 WS215F (with 5 m cord/flex tube attached)
  - 3 WS225 (with 5 m cord/cord type)

Note) For the details of types other than the above, refer to the specifications of the general purpose type.

Switch List

Kind	Switch symbol	Load voltage range	Load current range	Maximum open/close capacity	Protective circuit	Indicating lamp	Wiring method	Cord length	Applicable load device
Contact	AF AX101	DC:5 - 30V AC:5 - 120V	DC:5 - 40mA AC:5 - 20mA	DC:1.5W AC:2VA	None	LED (red light lights up during ON)	0.3 mm <sup>2</sup> 2-core, outside diameter, φ4 mm Rear wiring	1.5m	Small relay, programmable controller
	AG AX105							5m	
	AH AX111				1.5m				
	AJ AX115				5m				
	AE AX125	DC:30V or less AC:120V or less	DC:40mA or less AC:20mA or less	2VA	None	None	5m		
	AK AX11A	AC:5 - 120V	5 - 20mA		Present	LED (red light lights up during ON)	4-pin connector, type Rear wiring	0.5m	
	AL AX11B	DC:5 - 30V	5 - 40mA	1.5W				0.5m	
	AP AZ101	DC:5 - 30V AC:5 - 120V	DC:5 - 40mA AC:5 - 20mA	DC:1.5W AC:2VA	None	LED (red light lights up during ON)	0.3 mm <sup>2</sup> 2-core, outside diameter, φ4 mm Upper wiring	1.5m	
	AR AZ105							5m	
	AS AZ111				1.5m				
	AT AZ115				5m				
	AN AZ125	DC:30V or less AC:120V or less	DC:40mA or less AC:20mA or less	2VA	None	None	5m		
	AU AZ11A	AC:5 - 120V	5 - 20mA		Present	LED (red light lights up during ON)	4-pin connector type Upper wiring	0.5m	
	AW AZ11B	DC:5 - 30V	5 - 40mA	1.5W				0.5m	
	5 WR505	DC:5 - 50V AC:5 - 120V	DC:3 - 40mA AC:3 - 20mA	DC:1.5W AC:2VA	None	LED (red light lights up during ON)	0.3 mm <sup>2</sup> 2-core, outside diameter, φ4 mm Rear wiring	5m	
7 WR505F	5m								
6 WR515	5m								
S SR405	AC:80 - 220V	2 - 300mA	30VA	Present	Neon lamp (lamp lights up during OFF)	0.5mm <sup>2</sup> 2-core, outside diameter, φ6 mm Rear wiring	5m		
No contact	BE AX201	DC:5 - 30V	5 - 40mA	-	Present	LED (red light lights up during ON)	0.3 mm <sup>2</sup> 2-core, outside diameter, φ4 mm Rear wiring	1.5m	
	BF AX205							5m	
	CE AX211					LED (2-lamp type in red/green)	4-pin connector type Rear wiring	1.5m	
	CF AX215							5m	
	CH AX21C					LED (red light lights up during ON)	0.3 mm <sup>2</sup> 2-core, outside diameter, φ4 mm Upper wiring	0.5m	
	CJ AX21D							1m	
	BM AZ201					LED (red light lights up during ON)	0.3 mm <sup>2</sup> 2-core, outside diameter, φ4 mm Upper wiring	1.5m	
	BN AZ205							5m	
	CM AZ211					LED (2-lamp type in red/green)	0.3 mm <sup>2</sup> 2-core, outside diameter, φ4 mm Upper wiring	1.5m	
	CN AZ215							5m	
Cutting fluid proof type	RA AX205W	LED (red light lights up during ON)	0.3mm <sup>2</sup> 2-core, outside diameter, φ4 mm Rear wiring	0.3mm <sup>2</sup> 2-core, outside diameter, φ4 mm Upper wiring	5m				
	RB AZ205W					5m			
No contact	2 WS215	DC:10 - 30V	6 - 70mA	-	Present	LED (2-lamp type in red/green)	0.3 mm <sup>2</sup> 2-core, outside diameter, φ4 mm Rear wiring	5m	
	4 WS215F							5m	
	3 WS225							5m	
No contact (CE)	CT AX211CE	DC:5 - 30V	5 - 40mA	-	Present	LED (2-lamp type in red/green)	0.3 mm <sup>2</sup> 2-core, outside diameter, φ4 mm Rear wiring	1.5m	
	CU AX215CE							5m	
	CV AX21BCE						4-pin connector type Rear wiring	0.5m	
	CW AZ211CE							0.3 mm <sup>2</sup> 2-core, outside diameter, φ4 mm Upper wiring	1.5m
	CX AZ215CE						4-pin connector type Upper wiring		5m
	CY AZ21BCE							0.5m	

- Notes) ● For the switches without a protective circuit, be sure to provide the protective circuit (SK-100) with load devices when using induction load devices (relay, etc.).  
 ● For the handling of switches, be sure to refer to the switch specifications in the end of this catalogue.  
 ● All the AX type switches can be mounted. For the types other than the above, refer to the switch specifications in the end of this catalogue.  
 ● The WR and WS type switches are cutting fluid proof type.  
 ● SR405 switch can be used for only bore size φ32~φ125.  
 ● We have developed CE conformed switches. Please refer to the end of a book for detailed information.  
 ● We recommend AND UNIT (AU series) for multiple switches connected in series.

● General purpose type

AX type switch (Cord extended to rear)

● Cutting fluid proof type  
WR • WS type switch

● For the switch symbol , pay attention to the points below when ordering the cutting fluid proof type switches, WR and WS types.

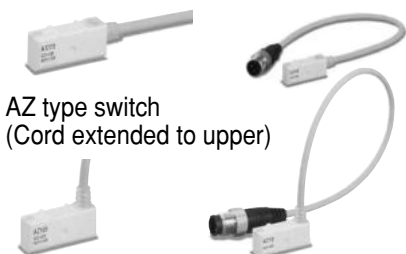

- |   |        |  |
|---|--------|--|
| 5 | WR505  | The switch and straight box connector (F-SB) are combined [the flex tube (F-05: 4.8 m) is required]. |
| 2 | WS215  |  |
| 7 | WR505F | The flex tube (F-05: 4.8 m) is attached to the switch and straight box connector (F-SB).             |
| 4 | WS215F |  |

### Mounting type

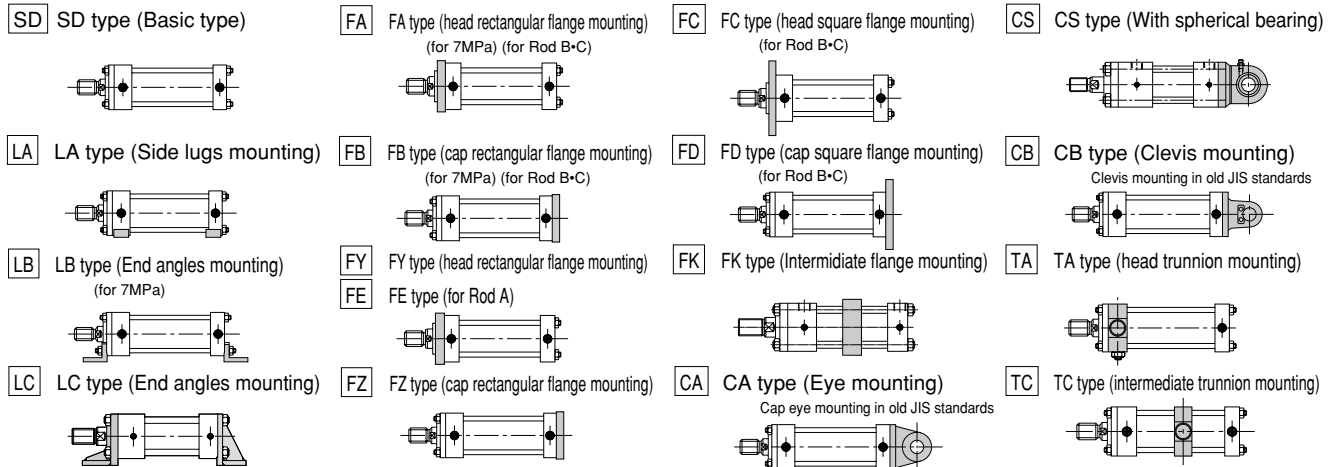

Note) The mounting type of the 7 MPa type cannot be used basically with the pressure exceeding 7 MPa. For the using method, contact us.

### Cushion valve position and air vent position depending on cylinder bore (for rod A only)

Bore  $\phi 40 \cdot \phi 50 \cdot \phi 100 \cdot \phi 140 \cdot \phi 150$

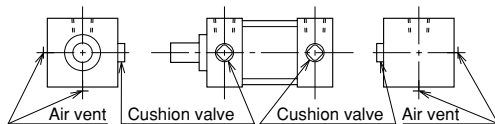

Bore  $\phi 63 \cdot \phi 80 \cdot \phi 125 \cdot \phi 160$

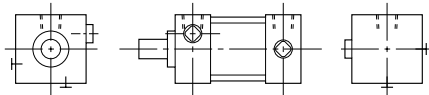

### The locations of port, cushion and check in case of LA mounting

Port position A surface

Port position B surface

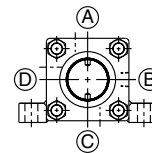
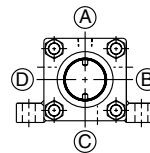

Port position C surface

Port position D surface

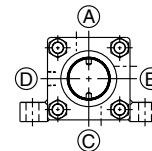
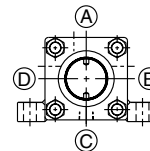

### Stroke fabrication range

Bore	Standard type	Switch set
$\phi 32 - \phi 50$	- 1200	- 1200
$\phi 63 \cdot \phi 80$	- 1600	- 1600
$\phi 100 - \phi 140$	- 2000	- 2000
$\phi 150 - \phi 250$	- 2000	-

- The above strokes indicate the maximum available strokes for the standard type. For the rod buckling, check with the buckling chart of the selection materials. If you request the strokes other than in the table above, contact us.
- Please refer to the 140L-1 series beyond above mentioned strokes. (140L-1, bore:63mm to 160mm, Maximum:3000mm stroke)  
\*140L-1 series is specially designed for long stroke, so not interchangeable with H-8 series.

### Adaptability of working oil to packing material

Packing material	Adaptable working oil				
	Petroleum-based fluid	Water-glycol fluid	Phosphate ester fluid	W/O Water in oil fluid	O/W Oil in water fluid
1 Nitrile rubber	○	○	×	○	○
2 Urethane rubber	◎	×	×	△	△
3 Fluoric rubber	○	×	○	○	○
6 Hydrogenated nitrile rubber	○	◎	×	◎	◎

- Notes) 1. The ◎ and ○-marked items are applicable, while the ×-marked items are inapplicable. For the use of the △-marked items, contact us.  
2. The ◎-marked items are the recommended packing materials in case of giving the first priority to abrasion resistance.

### Cutting fluid proof type/adaptability of cutting fluid to packing material

Packing material	Nonaqueous cutting fluid		Aqueous cutting fluid
	Type 1	Type 2	
6 Hydrogenated nitrile rubber	○	×	○

○ : applicable    × : inapplicable

For the working temperature range of packing materials, refer to the selection materials in the beginning of this catalogue.

**★ Port G (ISO1179-1) or NPT (Order-made)**

Please specify the model as following  
(ex.) 70H-8 2LA50BB100-G A B

Port G or NPT
Port position
Cushion valve position

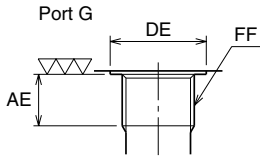

**Thread dimension table**

Unit : mm

Bore	G thread			NPT thread
	AE	DE	FF	
φ32	12	φ25.5	G3/8	NPT3/8
φ40	12	φ25.5	G3/8	NPT3/8
φ50	14	φ30	G1/2	NPT1/2
φ63	14	φ30	G1/2	NPT1/2
φ80	16	φ36.9	G3/4	NPT3/4
φ100	16	φ36.9	G3/4	NPT3/4
φ125	18	φ46.1	G1	NPT1
φ140	18	φ46.1	G1	NPT1
φ150	18	φ46.1	G1	NPT1
φ160	18	φ46.1	G1	NPT1

**Switch mounting minimum possible stroke**

Unit: mm

Bore mm	Mounting style	Types other than TC type						TC type					
		with a switch			with two switches			with a switch			with two switches		
		Switch quantity	AX type AX205W	WR type	WS type	AX type AX205W	WR type	WS type	AX type AX205W	WR type	WS type	AX type AX205W	WR type
φ32	20	20	45(35)	25	45(35)	50	70(60)	75(65)	110	155(135)	165(145)		
φ40	20	20	45(35)	25	45(35)	50	70(60)	75(65)	115	155(135)	165(145)		
φ50	20	20	45(30)	45(35)	25	40(30)	45(35)	50	70(60)	75(65)	115	155(135)	165(145)
φ63	20	20	40(30)	25	40(30)	60	85(75)	125	170(150)	175(155)			
φ80	20	20	40(30)	25	40(30)	60	85(75)	130	170(150)	175(155)			
φ100	20	20	35(25)	40(30)	25	35(25)	40(30)	65	85(75)	95(85)	135	175(150)	190(170)
φ125	20	20	35(25)	40(25)	25	35(25)	40(25)	70	90(80)	95(85)	150	185(160)	195(170)
φ140	20	20	-	-	25	-	-	95	-	-	175	-	-

**Notes)**

- For the TC type (with a switch), the cylinder strokes in case that the TC type attachment shown in the right figures are positioned in the place other than the center are shown in the table above.
- For the minimum PH dimension at the switch mounting, refer to the dimensional drawings of the TC type.
- The dimensions in the ( ) marks of the WR and WS types are the minimum strokes at the mounting of the WR505 and WS225.

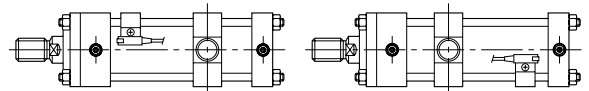

**★ Standard specifications**

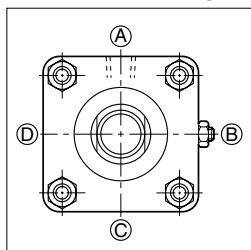

- With both ends cushions
- Port position ①, cushion valve position ②

**★ Semi-standard Fabrication range**

- With boots
- Magnetic proximity switch WR and WS types  
Note) The WR and WS types are the standard cutting fluid proof types.
- Modification of TC attachment (dimensional symbol: PH)
- Modification of FK dimension
- Plated cylinder tube (hard chrome plated 2/100 mm)
- Modification of piston rod end (dimensional symbol: W, A, KK)  
Refer to page 95.

**★ Modification of port position and cushion valve position**

The standard port position is ①, and the standard cushion valve position is ②. When modifying the positions, enter the symbols shown in the dimensional drawings.

Ex.) 70H-8R 2SD80BB100 - **B** **C** AH2  
 Port position (A, B, C, D)  
 Cushion valve position (A, B, C, D, 0)

- For the TA type, the standard port position and cushion valve position on the rod side are ① and ③, and those on the head side are ① and ②.
- In case that the cushion is not equipped, the cushion valve position is ④.

## Weight table/general purpose type, cutting fluid proof type

Unit: kg

Bore mm	Rod type	Basic weight (SD type)		Additional weight per 1 mm stroke		Mounting accessories weight															
		Standard type switch set	Double rod type	Standard type switch set	Double rod type	LA	LB	LC	FA	FB	FC	FD	FK	FE	FY	FZ	CA	CS	CB	TA	TC
φ32	B	3.3	4.1	0.006	0.008	0.3	0.3	0.48	0.1	0.6	0.6	0.9	1.1	—	0.2	0.7	0.4	—	0.5	0.1	0.5
	A	3.8	—	0.013	—			—	—	—			—	0.9							
φ40	B	3.5	4.4	0.011	0.014	0.5	0.5	0.63	0.2	0.7	0.7	1.1	1.2	—	0.3	0.8	0.5	0.6	0.6	0.1	0.6
	C	3.4	4.3	0.010	0.012																
	A	5.5	—	0.017	—																
φ50	B	5.0	6.4	0.014	0.019	0.9	0.7	0.88	0.7	1.2	1.5	2.0	2.2	—	1.1	1.6	1.0	1.1	1.2	0.4	1.0
	C	4.9	6.2	0.012	0.014																
	A	9.1	—	0.024	—																
φ63	B	7.9	10.2	0.019	0.027	1.0	1.2	1.5	1.0	1.8	2.2	3.0	3.6	—	1.6	2.4	2.0	1.9	2.6	0.6	1.2
	C	7.6	9.8	0.017	0.022																
	A	18.0	—	0.039	—																
φ80	B	16.2	20.3	0.032	0.045	1.8	2.0	2.5	1.1	3.0	2.8	4.7	4.7	—	2.1	4.0	3.0	3.6	3.6	0.6	2.1
	C	15.5	19.4	0.027	0.035																
	A	29.6	—	0.060	—																
φ100	B	26.0	32.7	0.048	0.067	2.1	2.9	3.63	1.8	4.8	4.6	7.4	8.9	—	3.9	6.9	5.5	6.7	6.7	1.0	3.8
	C	24.9	31.1	0.042	0.055																
	A	49.2	—	0.096	—																
φ125	B	42.9	53.6	0.077	0.107	3.2	5.5	6.88	2.9	8.4	8.0	13.0	12.6	—	6.2	12.1	9.9	12.8	12.1	2.1	6.2
	C	42.5	52.7	0.065	0.084																
	A	67.5	—	0.122	—																
φ140	B	59.6	73.9	0.100	0.140	3.8	7.7	9.63	3.2	11.1	9.2	17.1	20.4	—	8.2	16.1	16.7	—	21.0	4.1	11.1
	C	56.0	69.6	0.085	0.111																
	A	77.9	—	0.148	—																
φ150	B	69.6	86.5	0.118	0.162	4.8	9.6	12.0	4.9	13.7	16.6	22.4	22.9	—	10.7	19.5	18.2	—	26.8	4.6	10.9
	C	67.9	83.6	0.101	0.127																
	A	93.0	—	0.148	—																
φ160	B	84.3	114.6	0.121	0.171	5.4	10.0	13.0	5.3	16.5	19.0	25.2	31.2	—	11.3	22.5	22.9	—	28.4	5.2	14.8
	C	79.9	99.1	0.102	0.132																
	B	115.1	149.9	0.179	0.212																
φ180	C	108.5	140.1	0.157	0.168	7.9	13.8	24.4	7.7	22.7	25.0	33.6	—	—	17.5	32.5	33.8	—	42.9	18.6	19.4
	B	155.2	201.4	0.220	0.264																
φ200	C	147.3	189.0	0.192	0.209	11.4	21.0	36.3	10.6	31.6	28.8	48.7	—	—	22.6	43.6	51.4	—	65.4	24.3	27.2
	B	203.8	268.7	0.268	0.331																
φ224	C	190.9	247.7	0.234	0.262	12.7	32.0	57.0	11.6	41.5	33.2	63.1	—	—	30.6	60.5	65.6	—	82.7	36.5	36.5
	B	283.7	374.5	0.333	0.411																
φ250	C	264.1	344.1	0.290	0.324	18.3	46.7	77.6	17.5	55.1	48.2	88.3	—	—	42.5	80.1	74.5	—	91.6	27.0	43.3
	B	283.7	374.5	0.333	0.411																

## Switch additional weight

Unit: kg

Switch Bore (mm)	AX type			SR type	WR, WS types
	Cord length 1.5 m	Cord length 5 m	Connector type	Cord length 5m	
φ32 - φ50	0.05	0.13	0.04	0.22	0.5
φ63	0.07	0.14	0.06	0.22	
φ80 • φ100	0.07	0.15	0.06	0.22	
φ125	0.09	0.16	0.07	0.22	
φ140	0.09	0.16	0.08	—	

Calculation formula cylinder weight (kg) = basic weight + (cylinder stroke mm × additional weight per 1 mm stroke) + (switch additional weight × switch quantity) + mounting accessories weight + rod end attachment weight

Calculation example 140H-8R, bore φ80, rod B, cylinder stroke 200 mm, 2 pcs. of AX215, LA type  
 $16.2 + (0.032 \times 200) + (0.15 \times 2) + 1.8 = 24.7$  kg



Unit: kg

Bore mm	Rod type	Rod end attachment weight					
		Rod end eye (T-end)	Rod end eye (S-end)	Rod end clevis (Y-end w/ pin)	Floating joint (F-end)	Lock nut	Separate flange joint (M type joint)
φ32	B	0.5	—	0.7	0.39	0.02	0.3
	A	—	—	—	—	0.05	0.6
φ40	B	0.5	0.7	0.7	0.75	0.03	0.4
	C		0.7		0.39	0.02	—
φ50	A	—	—	—	—	0.11	0.8
	B	1.0	1.1	1.2	1.41	0.05	0.6
	C		1.2		0.75	0.03	—
φ63	A	—	—	—	—	0.24	1.4
	B	2.7	2.1	3.9	2.68	0.11	0.8
	C		2.3		1.41	0.05	—
φ80	A	—	—	—	—	0.52	3.0
	B	2.2	3.2	3.7	—	0.24	1.4
	C		3.6		2.68	0.11	—
φ100	A	—	—	—	—	1.10	5.3
	B	4.2	6.7	7.7	—	0.52	3.0
	C		7.3		—	0.24	—
φ125	A	—	—	—	—	1.93	10.6
	B	8.0	12.4	14.6	—	1.10	5.3
	C		13.7		—	0.52	—
φ140	A	—	—	—	—	2.90	—
	B	19.0	—	28.8	—	1.44	7.0
	C		—		—	0.77	—
φ150	A	—	—	—	—	3.24	—
	B	18.9	—	28.3	—	1.65	9.3
	C		—		—	0.94	—
φ160	A	—	—	—	—	3.24	—
	B	22.7	—	34.2	—	1.93	10.6
	C		—		—	1.10	—
φ180	B	37.6	—	53.7	—	2.90	—
	C		—		—	1.44	—
φ200	B	53.9	—	87.4	—	3.24	—
	C		—		—	1.93	—
φ224	B	77.2	—	128.3	—	5.97	—
	C		—		—	2.90	—
φ250	B	74.4	—	123.9	—	7.77	—
	C		—		—	3.24	—

70-140H-8/TH8 Bore A.C CAD/DATA is available.



### SD

70H-8	1	SD	Bore	B	B	Stroke	-	A	B
140H-8	1	SD	Bore	B	B	Stroke	-	A	B

Rod dia.	OF	DF
φ100	φ99.5	φ12
φ112	φ111.5	φ15
φ125	φ124.5	φ15
φ140	φ139.5	φ15

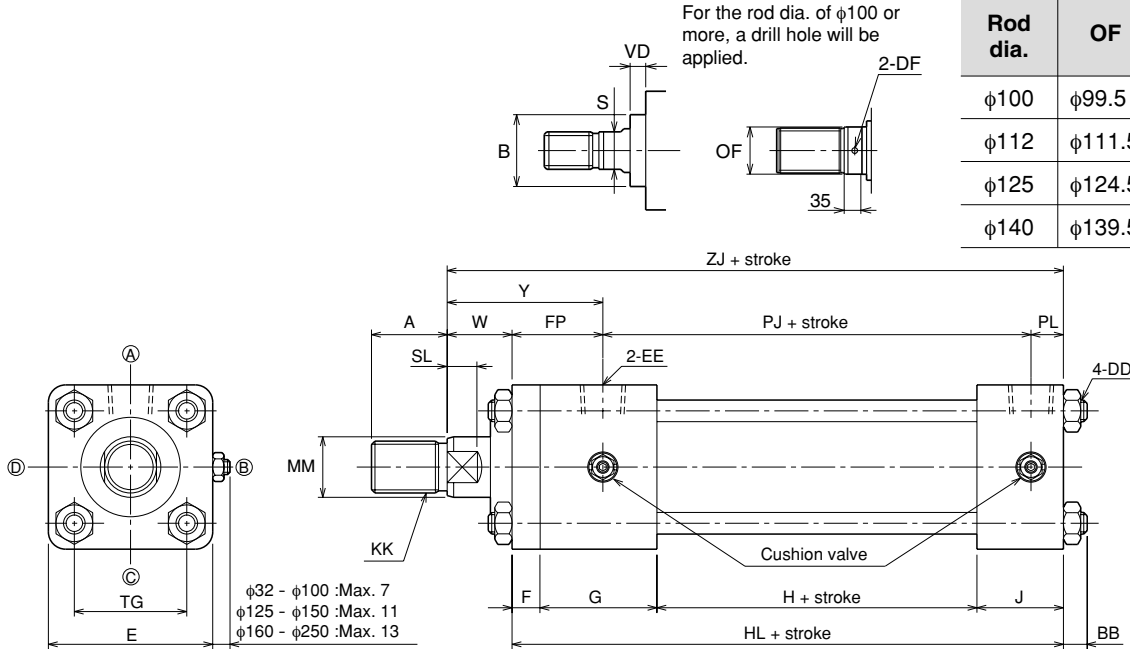

General purpose hydraulic cylinder

- For the use of the SD type, be sure to refer to the "Precautions for use, 4. Mounting" in the beginning of this catalogue.
- For the screw length (dimension A) in the case of using the lock nut, refer to "Accessories".
- For the mounting of switches, refer to the dimensional drawings of "Switch set". All the contents other than "switch mounting dimensions" are identical.
- If the port's sizes are greater than 1 inch, we recommend you to order G thread or pipe flange. Please feel free to contact us. (Order made)

### Double rod type (φ32 - φ250/rod B, C) For both ends loaded type

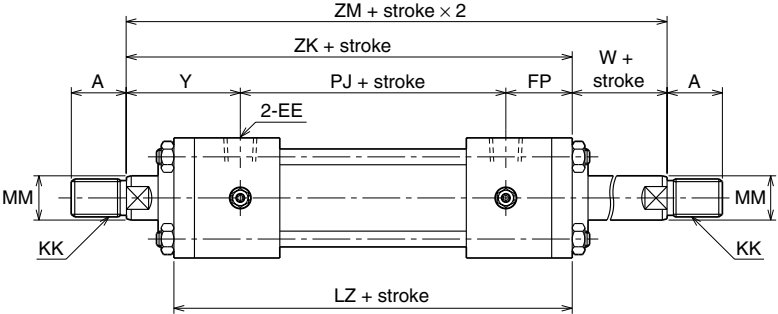

- The switch set (φ32 - φ140) is also within the fabrication range.

### With boots

70-140H-8/TH8 BoreK

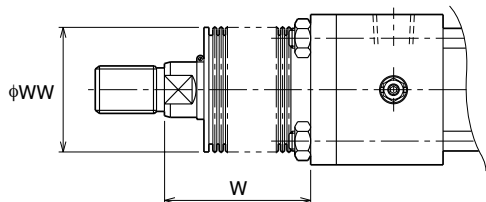

Rod B • C Nylon tarpaulin Chloroprene	φ32	1/3	Stroke + X
	φ40 • φ50	1/3.5	Stroke + X
	φ63 - φ100	1/4	Stroke + X
	φ125 - φ200	1/5	Stroke + X
	φ224 • φ250	1/6	Stroke + X
Conex	φ32	1/2	Stroke + X
	φ40 • φ50	1/2.5	Stroke + X
	φ63 - φ100	1/3	Stroke + X
	φ125 • φ140	1/3.5	Stroke + X
	φ150 - φ200	1/4	Stroke + X
	φ224 • φ250	1/4.5	Stroke + X

	Standard	Semi-standard	
<b>Material</b>	Nylon tarpaulin	Chloroprene	Conex
<b>Resistible temperature</b>	80°C	130°C	200°C

Notes) • Remember that the resistible temperatures shown in the table above are for the boots, not for the cylinder.  
• Conex is the registered trademark of Teijin Ltd.  
• If decimals are included into the calculation results, raise them to the next whole number.  
• The boots have been mounted at our factory prior to delivery.

Rod A Nylon tarpaulin Chloroprene	φ40	1/3.5	Stroke + X
	φ50 - φ80	1/4	Stroke + X
	φ100 - φ160	1/5	Stroke + X
Conex	φ40	1/2.5	Stroke + X
	φ50 - φ80	1/3	Stroke + X
	φ100	1/3.5	Stroke + X
	φ125 - φ160	1/4	Stroke + X

# 7/14 MPa double acting hydraulic cylinder

## Double acting single rod/double rod

Unit: mm

# 70/140H-8

50

### Dimensional table

Symbol Bore	Rod B							Rod C							Rod A								
	A	B	KK	MM	S	SL	VD	A	B	KK	MM	S	SL	VD	A	B	KK	MM	S	SL	VD		
φ32	25	φ34	M16×1.5	φ18	14	10	10	-	-	-	-	-	-	-	-	-	-	-	-	-	-	-	
φ40	30	φ40	M20×1.5	φ22.4	19	11	10	25	φ36	M16×1.5	φ18	14	10	10	35	φ43	M24×1.5	φ28	24	14	17		
φ50	35	φ46	M24×1.5	φ28	24	14	10	30	φ40	M20×1.5	φ22.4	19	11	10	45	φ50	M30×1.5	φ35.5	30	16	17		
φ63	45	φ55	M30×1.5	φ35.5	30	16	10	35	φ46	M24×1.5	φ28	24	14	10	60	φ65	M39×1.5	φ45	41	20	19		
φ80	60	φ65	M39×1.5	φ45	41	20	10	45	φ55	M30×1.5	φ35.5	30	16	9	75	φ80	M48×1.5	φ56	50	23	20		
φ100	75	φ80	M48×1.5	φ56	50	23	10	60	φ65	M39×1.5	φ45	41	20	10	95	φ95	M64×2	φ71	65	27	23		
φ125	95	φ95	M64×2	φ71	65	27	10	75	φ80	M48×1.5	φ56	50	23	10	120	φ115	M80×2	φ90	85	33	17		
φ140	110	φ105	M72×2	φ80	75	31	10	80	φ85	M56×2	φ63	55	24	10	140	φ125	M95×2	φ100	-	Drill hole	17		
φ150	115	φ110	M76×2	φ85	80	33	10	85	φ90	M60×2	φ67	60	30	10	140	φ125	M95×2	φ100	-	Drill hole	15		
φ160	120	φ115	M80×2	φ90	85	33	10	95	φ95	M64×2	φ71	65	27	10	150	φ140	M100×2	φ112	-	Drill hole	16		
φ180	140	φ125	M95×2	φ100	-	Drill hole	10	110	φ105	M72×2	φ80	75	31	10	-	-	-	-	-	-	-	-	
φ200	150	φ140	M100×2	φ112	-	Drill hole	10	120	φ115	M80×2	φ90	85	33	10	-	-	-	-	-	-	-	-	
φ224	180	φ150	M120×2	φ125	-	Drill hole	10	140	φ125	M95×2	φ100	-	Drill hole	10	-	-	-	-	-	-	-	-	
φ250	195	φ170	M130×2	φ140	-	Drill hole	10	150	φ140	M100×2	φ112	-	Drill hole	10	-	-	-	-	-	-	-	-	

Symbol Bore	BB	DD	E	EE	F	FP	G	H	HL	J	LZ	PJ	PL	TG	W		Y		ZJ		ZK	ZM
															B·C	A	B·C	A	B·C	A		
φ32	11	M10×1.25	□58	Rc 3/8	11	38	50	44	141	36	166	90	13	□38	30	-	68	-	171	-	196	226
φ40	11	M10×1.25	□65	Rc 3/8	11	38	50	44	141	36	166	90	13	□45	30	35	68	73	171	176	196	226
φ50	11	M10×1.25	□76	Rc 1/2	13	42	54	48	155	40	182	98	15	□52	30	41	72	83	185	196	212	242
φ63	13	M12×1.5	□90	Rc 1/2	15	46	56	52	163	40	194	102	15	□63	35	48	81	94	198	211	229	264
φ80	16	M16×1.5	□110	Rc 3/4	18	56	66	54	184	46	222	110	18	□80	35	51	91	107	219	235	257	292
φ100	18	M18×1.5	□135	Rc 3/4	20	58	66	60	192	46	232	116	18	□102	40	57	98	115	232	249	272	312
φ125	21	M22×1.5	□165	Rc 1	24	67	76	64	220	56	264	130	23	□122	45	57	112	124	265	277	309	354
φ140	22	M24×1.5	□185	Rc 1	26	69	76	72	230	56	276	138	23	□138	50	57	119	126	280	287	326	376
φ150	25	M27×1.5	□196	Rc 1	28	71	76	80	240	56	288	146	23	□148	50	57	121	128	290	297	338	388
φ160	25	M27×1.5	□210	Rc 1	31	74	81	80	253	61	304	156	23	□160	55	57	129	131	308	310	359	414
φ180	27	M30×1.5	□235	Rc 1 1/4	33	75	85	86	275	71	322	172	28	□182	55	-	130	-	330	-	377	432
φ200	29	M33×1.5	□262	Rc 1 1/2	37	85	95	90	301	79	354	184	32	□200	55	-	140	-	356	-	409	464
φ224	34	M39×1.5	□292	Rc 1 1/2	41	89	95	90	305	79	362	184	32	□225	60	-	149	-	365	-	422	482
φ250	37	M42×1.5	□325	Rc 2	46	106	115	90	346	95	412	200	40	□250	65	-	171	-	411	-	477	542

• Allowance of B is h8, allowance of MM is f8.

### With boots

Symbol	Bore	φ32	φ40	φ50	φ63	φ80	φ100	φ125	φ140	φ150	φ160	φ180	φ200	φ224	φ250
		WW	Rod B	40	50	63	71	80	100	125	125	140	140	160	180
Rod C	-		50	50	63	71	80	100	125	125	125	125	140	160	180
Rod A	-		63	71	80	100	125	140	160	160	180	-	-	-	-
X	Rod B	45	45	45	55	55	55	65	65	65	65	65	65	80	80
	Rod C	-	45	45	55	55	55	65	65	65	65	65	65	80	80
	Rod A	-	45	55	55	55	65	65	65	65	65	-	-	-	-

General purpose hydraulic cylinder

70-140H-8/TH8 Bore A.C CAD/DATA is available.



### LA

70H-8	1	LA	Bore	B	B	Stroke	-	A	B
140H-8	1	LA	Bore	B	B	Stroke	-	A	B

For the rod dia. of  $\phi 100$  or more, a drill hole will be applied.

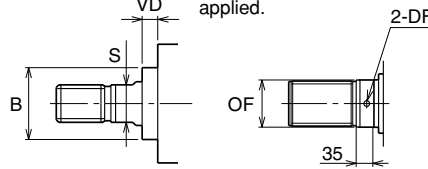

Rod dia.	OF	DF
$\phi 100$	$\phi 99.5$	$\phi 12$
$\phi 112$	$\phi 111.5$	$\phi 15$
$\phi 125$	$\phi 124.5$	$\phi 15$
$\phi 140$	$\phi 139.5$	$\phi 15$

General purpose hydraulic cylinder

#### • Bore $\phi 32 - \phi 160$

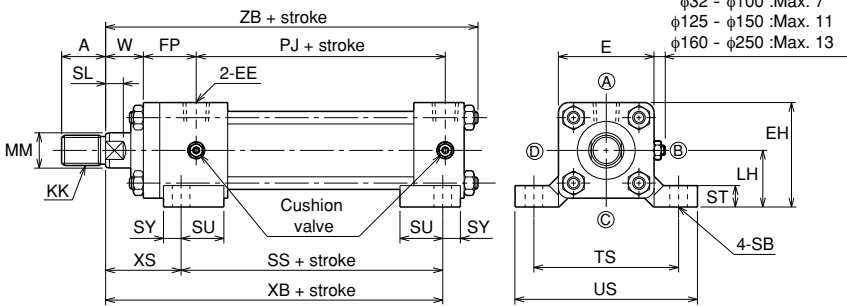

#### • Bore $\phi 180 - \phi 250$

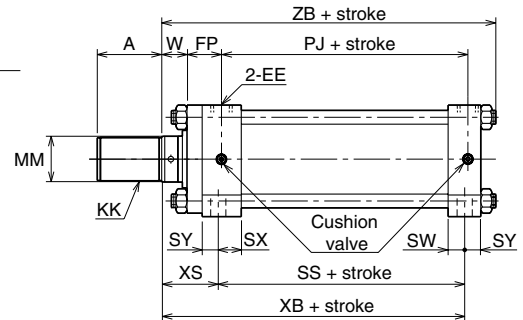

- For the dimensions other than in the diagram above, refer to the specification of the SD type (standard type).
- For the mounting of switches, refer to the dimensional drawings of "Switch set". All the contents other than "Switch mounting dimensions" are identical.
- If the port's sizes are greater than 1 inch, we recommend you to order G thread or pipe flange. Please feel free to contact us. (Order made)

#### Double rod type ( $\phi 32 - \phi 250$ /rod B, C) For both ends loaded type

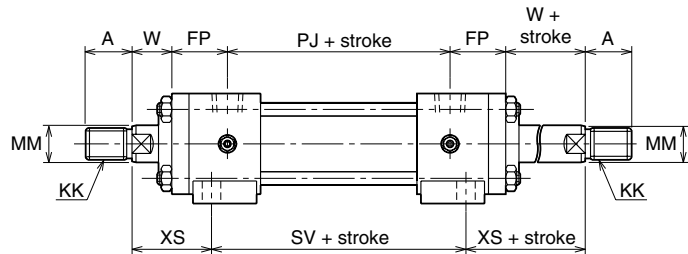

- The switch set ( $\phi 32 - \phi 140$ ) is also within the fabrication range.

#### With boots

70-140H-8/TH8 BoreK

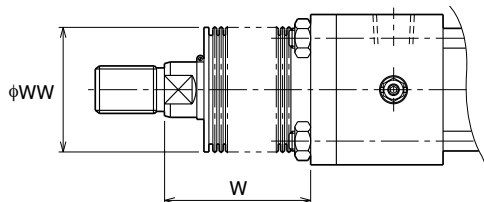

Rod B • C Nylon tarpaulin Chloroprene	$\phi 32$	1/3	Stroke + X
	$\phi 40 \cdot \phi 50$	1/3.5	Stroke + X
	$\phi 63 - \phi 100$	1/4	Stroke + X
	$\phi 125 - \phi 200$	1/5	Stroke + X
	$\phi 224 \cdot \phi 250$	1/6	Stroke + X
Conex	$\phi 32$	1/2	Stroke + X
	$\phi 40 \cdot \phi 50$	1/2.5	Stroke + X
	$\phi 63 - \phi 100$	1/3	Stroke + X
	$\phi 125 \cdot \phi 140$	1/3.5	Stroke + X
	$\phi 150 - \phi 200$	1/4	Stroke + X
	$\phi 224 \cdot \phi 250$	1/4.5	Stroke + X

	Standard	Semi-standard	
<b>Material</b>	Nylon tarpaulin	Chloroprene	Conex
<b>Resistible temperature</b>	80°C	130°C	200°C

- Notes) • Remember that the resistible temperatures shown in the table above are for the boots, not for the cylinder.  
 • Conex is the registered trademark of Teijin Ltd.  
 • If decimals are included into the calculation results, raise them to the next whole number.  
 • The boots have been mounted at our factory prior to delivery.

Rod A Nylon tarpaulin Chloroprene	$\phi 40$	1/3.5	Stroke + X
	$\phi 50 - \phi 80$	1/4	Stroke + X
	$\phi 100 - \phi 160$	1/5	Stroke + X
Conex	$\phi 40$	1/2.5	Stroke + X
	$\phi 50 - \phi 80$	1/3	Stroke + X
	$\phi 100$	1/3.5	Stroke + X
	$\phi 125 - \phi 160$	1/4	Stroke + X

# 7/14 MPa double acting hydraulic cylinder

## Double acting single rod/double rod

Unit: mm

# 70/140H-8

### Dimensional table

Symbol Bore	Rod B							Rod C							Rod A								
	A	B	KK	MM	S	SL	VD	A	B	KK	MM	S	SL	VD	A	B	KK	MM	S	SL	VD		
φ32	25	φ34	M16×1.5	φ18	14	10	10	—	—	—	—	—	—	—	—	—	—	—	—	—	—	—	
φ40	30	φ40	M20×1.5	φ22.4	19	11	10	25	φ36	M16×1.5	φ18	14	10	10	35	φ43	M24×1.5	φ28	24	14	17	17	
φ50	35	φ46	M24×1.5	φ28	24	14	10	30	φ40	M20×1.5	φ22.4	19	11	10	45	φ50	M30×1.5	φ35.5	30	16	17	17	
φ63	45	φ55	M30×1.5	φ35.5	30	16	10	35	φ46	M24×1.5	φ28	24	14	10	60	φ65	M39×1.5	φ45	41	20	19	19	
φ80	60	φ65	M39×1.5	φ45	41	20	10	45	φ55	M30×1.5	φ35.5	30	16	9	75	φ80	M48×1.5	φ56	50	23	20	20	
φ100	75	φ80	M48×1.5	φ56	50	23	10	60	φ65	M39×1.5	φ45	41	20	10	95	φ95	M64×2	φ71	65	27	23	23	
φ125	95	φ95	M64×2	φ71	65	27	10	75	φ80	M48×1.5	φ56	50	23	10	120	φ115	M80×2	φ90	85	30	17	17	
φ140	110	φ105	M72×2	φ80	75	31	10	80	φ85	M56×2	φ63	55	24	10	140	φ125	M95×2	φ100	—	Drill hole	17	17	
φ150	115	φ110	M76×2	φ85	80	33	10	85	φ90	M60×2	φ67	60	30	10	140	φ125	M95×2	φ100	—	Drill hole	15	15	
φ160	120	φ115	M80×2	φ90	85	33	10	95	φ95	M64×2	φ71	65	27	10	150	φ140	M100×2	φ112	—	Drill hole	16	16	
φ180	140	φ125	M95×2	φ100	—	Drill hole	10	110	φ105	M72×2	φ80	75	31	10	—	—	—	—	—	—	—	—	—
φ200	150	φ140	M100×2	φ112	—	Drill hole	10	120	φ115	M80×2	φ90	85	33	10	—	—	—	—	—	—	—	—	—
φ224	180	φ150	M120×2	φ125	—	Drill hole	10	140	φ125	M95×2	φ100	—	Drill hole	10	—	—	—	—	—	—	—	—	—
φ250	195	φ170	M130×2	φ140	—	Drill hole	10	150	φ140	M100×2	φ112	—	Drill hole	10	—	—	—	—	—	—	—	—	—

Symbol Bore	E	EE	EH	FP	LH	PJ	SB	SS	ST	SU	SV	SW	SX	SY	TS	US	W		XB		XS		ZB		
																	B·C	A	B·C	A	B·C	A	B·C	A	
φ32	□58	Rc 3/8	64	38	35±0.15	90	φ11	98	12	31	112	—	—	13	88	109	30	—	155	—	57	—	182	—	—
φ40	□65	Rc 3/8	70	38	37.5±0.15	90	φ11	98	14	31	112	—	—	13	95	118	30	35	155	160	57	62	182	187	—
φ50	□76	Rc 1/2	83	42	45±0.15	98	φ14	108	17	34	122	—	—	14	115	145	30	41	168	179	60	71	196	207	—
φ63	□90	Rc 1/2	95	46	50±0.15	102	φ18	106	19	32	122	—	—	18	132	165	35	48	177	190	71	84	211	224	—
φ80	□110	Rc 3/4	115	56	60±0.25	110	φ18	124	25	42	144	—	—	18	155	190	35	51	198	214	74	90	235	251	—
φ100	□135	Rc 3/4	138.5	58	71±0.25	116	φ22	122	27	38	142	—	—	22	190	230	40	57	207	224	85	102	250	267	—
φ125	□165	Rc 1	167.5	67	85±0.25	130	φ26	136	32	41	156	—	—	25	224	272	45	57	235	247	99	111	286	298	—
φ140	□185	Rc 1	187.5	69	95±0.25	138	φ26	144	35	41	164	—	—	25	250	300	50	57	250	257	106	113	302	309	—
φ150	□196	Rc 1	204	71	106±0.25	146	φ30	146	37	38	166	—	—	28	270	320	50	57	257	264	111	118	315	322	—
φ160	□210	Rc 1	217	74	112±0.25	156	φ33	150	42	40	170	—	—	31	285	345	55	57	272	274	122	124	333	335	—
φ180	□235	Rc 1 1/4	242.5	75	125±0.25	172	φ33	172	47	—	186	36	50	35	315	375	55	—	295	—	123	—	357	—	—
φ200	□262	Rc 1 1/2	271	85	140±0.25	184	φ36	186	52	—	202	40	56	39	355	425	55	—	317	—	131	—	385	—	—
φ224	□292	Rc 1 1/2	296	89	150±0.25	184	φ42	186	52	—	202	40	56	39	395	475	60	—	326	—	140	—	399	—	—
φ250	□325	Rc 2	332.5	106	170±0.25	200	φ45	206	57	—	226	48	68	47	425	515	65	—	364	—	158	—	448	—	—

• Allowance of B is h8, allowance of MM is f8.

### With boots

Bore		φ32	φ40	φ50	φ63	φ80	φ100	φ125	φ140	φ150	φ160	φ180	φ200	φ224	φ250
Symbol	Rod B	40	50	63	71	80	100	125	125	140	140	160	180	180	200
	Rod C	—	50	50	63	71	80	100	125	125	125	125	140	160	180
	Rod A	—	63	71	80	100	125	140	160	160	180	—	—	—	—
X	Rod B	45	45	45	55	55	55	65	65	65	65	65	65	80	80
	Rod C	—	45	45	55	55	55	65	65	65	65	65	65	80	80
	Rod A	—	45	55	55	55	65	65	65	65	65	—	—	—	—

70-140H-8/TH8 Bore A.C CAD/DATA is available.



### LB For 7 MPa

70H-8 1 LB Bore B B Stroke - A B

LB accessory working face  
(φ32 - φ80)

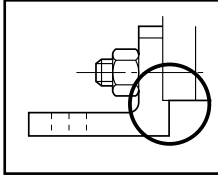

φ32 - φ100 :Max. 7  
φ125 - φ150 :Max. 11  
φ160 - φ250 :Max. 13

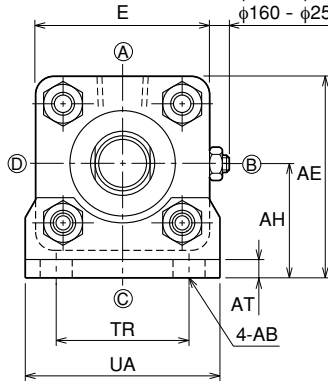

For the rod dia. of φ100 or more, a drill hole will be applied.

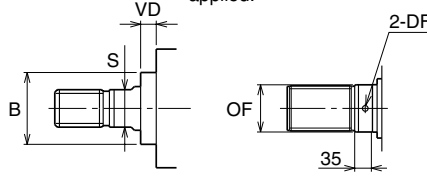

Rod dia.	OF	DF
φ100	φ99.5	φ12
φ112	φ111.5	φ15
φ125	φ124.5	φ15
φ140	φ139.5	φ15

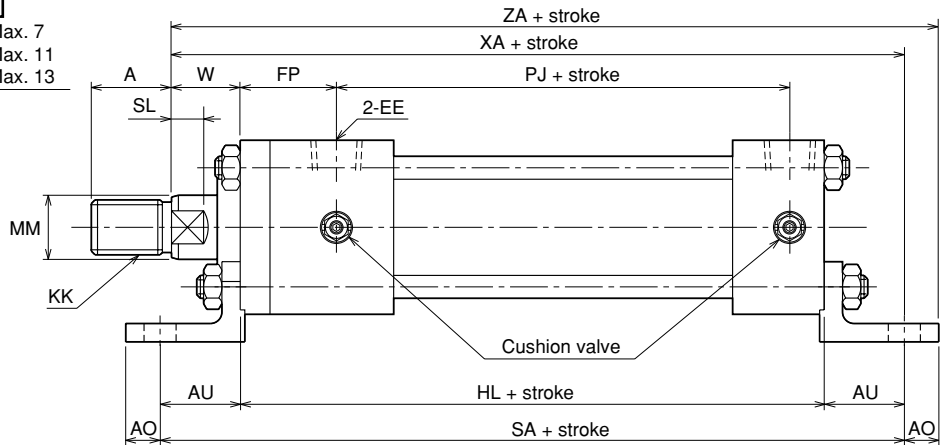

- For the dimensions other than in the diagram above, refer to the specification of the SD type (standard type).
- For the mounting of switches, refer to the dimensional drawings of "Switch set". All the contents other than "Switch mounting dimensions" are identical.
- If the port's sizes are greater than 1 inch, we recommend you to order G thread or pipe flange. Please feel free to contact us. (Order made)

### Double rod type (φ32 - φ250/rod B, C) For both ends loaded type

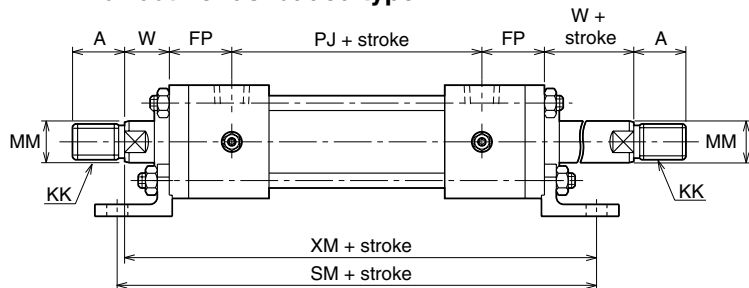

- The switch set (φ32 - φ140) is also within the fabrication range.

### With boots

70-140H-8/TH8 BoreK

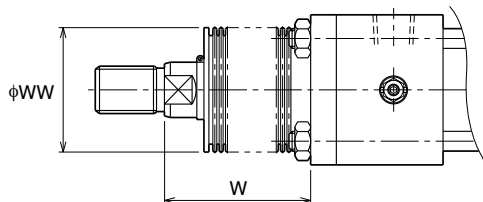

Material	Rod Dia.	Stroke	Dimension
Nylon tarpaulin Chloroprene	φ32	1/3	Stroke + X
	φ40 • φ50	1/3.5	Stroke + X
	φ63 - φ100	1/4	Stroke + X
	φ125 - φ200	1/5	Stroke + X
	φ224 - φ250	1/6	Stroke + X
Conex	φ32	1/2	Stroke + X
	φ40 • φ50	1/2.5	Stroke + X
	φ63 - φ100	1/3	Stroke + X
	φ125 • φ140	1/3.5	Stroke + X
	φ150 - φ200	1/4	Stroke + X
	φ224 • φ250	1/4.5	Stroke + X

	Standard	Semi-standard	
<b>Material</b>	Nylon tarpaulin	Chloroprene	Conex
<b>Resistible temperature</b>	80°C	130°C	200°C

- Notes)
- Remember that the resistible temperatures shown in the table above are for the boots, not for the cylinder.
  - Conex is the registered trademark of Teijin Ltd.
  - If decimals are included into the calculation results, raise them to the next whole number.
  - The boots have been mounted at our factory prior to delivery.
  - The boots is not available for 'A' type rod in LB mounting.



### LC

70H-8	1	LC	Bore	B	B	Stroke	-	A	B
140H-8	1	LC	Bore	B	B	Stroke	-	A	B

Detail of LC mounting working face ( $\phi 32 - \phi 80$ )

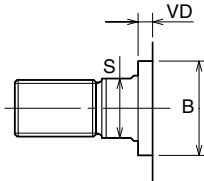
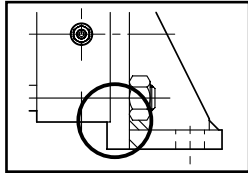

Rod dia.	OF	DF
$\phi 100$	$\phi 99.5$	$\phi 12$
$\phi 112$	$\phi 111.5$	$\phi 15$
$\phi 125$	$\phi 124.5$	$\phi 15$
$\phi 140$	$\phi 139.5$	$\phi 15$

General purpose hydraulic cylinder

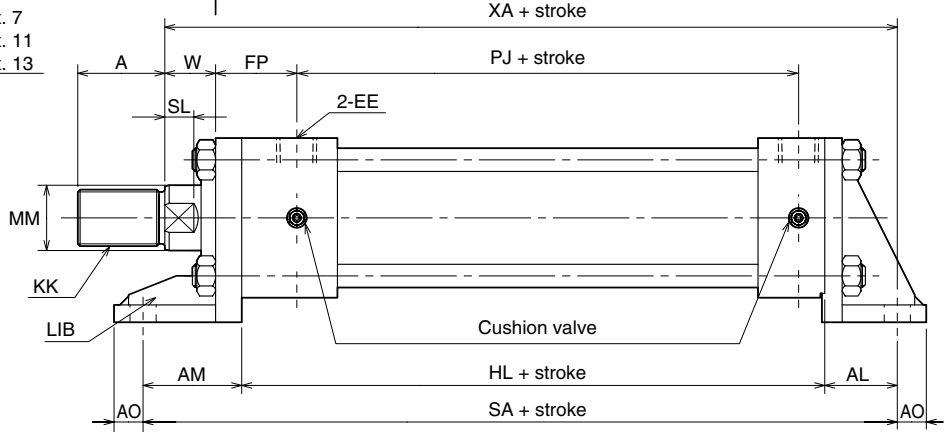
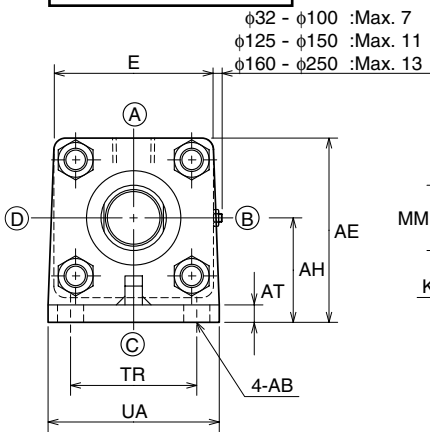

- For the dimensions other than in the diagram above, refer to the specification of the SD type (standard type).
- For the mounting of switches, refer to the dimensional drawings of "Switch set". All the contents other than "Switch mounting dimensions" are identical.
- The reinforcing plate is not being attached to the LC mounting bracket in case of under 63mm bore.
- If the port's sizes are greater than 1 inch, we recommend you to order G thread or pipe flange. Please feel free to contact us. (Order made)

Note) If you fixing the Rod end clevis (Y-end) as following drawing, it will cause interference with the rib of the LC mounting. Please feel free to contact us for the solution.

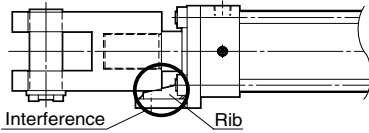

#### Double rod type ( $\phi 32 - \phi 250$ /rod B, C) For both ends loaded type

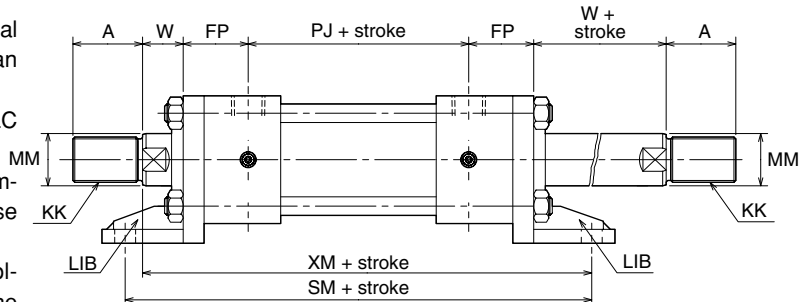

- The switch set ( $\phi 32 - \phi 140$ ) is also within the fabrication range.

#### With boots

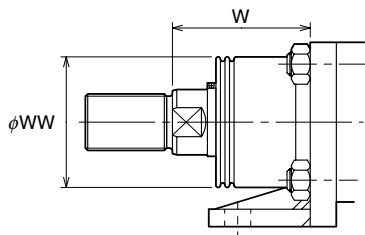

Material	Boots	Stroke	Stroke + X
Rod B · C Nylon tarpaulin Chloroprene	$\phi 32$	1/3	Stroke + X
	$\phi 40 \cdot \phi 50$	1/3.5	Stroke + X
	$\phi 63 - \phi 100$	1/4	Stroke + X
	$\phi 125 - \phi 200$	1/5	Stroke + X
	$\phi 224 - \phi 250$	1/6	Stroke + X
Conex	$\phi 32$	1/2	Stroke + X
	$\phi 40 \cdot \phi 50$	1/2.5	Stroke + X
	$\phi 63 - \phi 100$	1/3	Stroke + X
	$\phi 125 \cdot \phi 140$	1/3.5	Stroke + X
	$\phi 150 - \phi 200$	1/4	Stroke + X
	$\phi 224 \cdot \phi 250$	1/4.5	Stroke + X

	Standard	Semi-standard	
Material	Nylon tarpaulin	Chloroprene	Conex
Resistible temperature	80°C	130°C	200°C

- Notes)
- Remember that the resistible temperatures shown in the table above are for the boots, not for the cylinder.
  - Conex is the registered trademark of Teijin Ltd.
  - If decimals are included into the calculation results, raise them to the next whole number.
  - The boots have been mounted at our factory prior to delivery.



Dimensional table

Symbol Bore	Rod B							Rod C						
	A	B	KK	MM	S	SL	VD	A	B	KK	MM	S	SL	VD
φ32	25	φ34	M16×1.5	φ18	14	10	10	—	—	—	—	—	—	—
φ40	30	φ40	M20×1.5	φ22.4	19	11	10	25	φ36	M16×1.5	φ18	14	10	10
φ50	35	φ46	M24×1.5	φ28	24	14	10	30	φ40	M20×1.5	φ22.4	19	11	10
φ63	45	φ55	M30×1.5	φ35.5	30	16	10	35	φ46	M24×1.5	φ28	24	14	10
φ80	60	φ65	M39×1.5	φ45	41	20	10	45	φ55	M30×1.5	φ35.5	30	16	9
φ100	75	φ80	M48×1.5	φ56	50	23	10	60	φ65	M39×1.5	φ45	41	20	10
φ125	95	φ95	M64×2	φ71	65	27	10	75	φ80	M48×1.5	φ56	50	23	10
φ140	110	φ105	M72×2	φ80	75	31	10	80	φ85	M56×2	φ63	55	24	10
φ150	115	φ110	M76×2	φ85	80	33	10	85	φ90	M60×2	φ67	60	30	10
φ160	120	φ115	M80×2	φ90	85	33	10	95	φ95	M64×2	φ71	65	27	10
φ180	140	φ125	M95×2	φ100	—	Drill hole	10	110	φ105	M72×2	φ80	75	31	10
φ200	150	φ140	M100×2	φ112	—	Drill hole	10	120	φ115	M80×2	φ90	85	33	10
φ224	180	φ150	M120×2	φ125	—	Drill hole	10	140	φ125	M95×2	φ100	—	Drill hole	10
φ250	195	φ170	M130×2	φ140	—	Drill hole	10	150	φ140	M100×2	φ112	—	Drill hole	10

Symbol Bore	AB	AE	AH	AL	AM	AO	AT	E	EE	FP	HL	PJ	SA	TR	UA	W	XA	XM	SM
φ32	φ11	69	40±0.15	32	43	13	8	58	Rc3/8	38	130	90	205	40	62	30	203	228	230
φ40	φ11	75.5	43±0.15	32	43	13	8	65	Rc3/8	38	130	90	205	46	69	30	203	228	230
φ50	φ14	88	50±0.15	35	48	15	8	76	Rc1/2	42	142	98	225	58	85	30	220	247	252
φ63	φ18	105	60±0.15	42	57	18	10	90	Rc1/2	46	148	102	247	65	98	35	240	271	278
φ80	φ18	127	72±0.25	50	68	20	12	110	Rc3/4	56	166	110	284	87	118	35	269	307	322
φ100	φ22	152.5	85±0.25	55	75	23	12	135	Rc3/4	58	172	116	302	109	150	40	287	327	342
φ125	φ26	187.5	105±0.25	66	90	29	15	165	Rc1	67	196	130	352	130	175	45	331	375	396
φ140	φ26	207.5	115±0.25	70	96	30	18	185	Rc1	69	204	138	370	145	195	50	350	396	416
φ150	φ30	221	123±0.25	75	103	30	18	196	Rc1	71	212	146	390	155	210	50	365	413	438
φ160	φ33	237	132±0.25	75	106	35	18	210	Rc1	74	222	156	403	170	225	55	383	434	454
φ180	φ33	265.5	148±0.25	85	118	40	20	235	Rc1 1/4	75	242	172	445	185	243	55	415	462	492
φ200	φ36	296	165±0.25	98	135	40	25	262	Rc1 1/2	85	264	184	497	206	272	55	454	507	550
φ224	φ42	331	185±0.25	115	156	45	30	292	Rc1 1/2	89	264	184	535	230	310	60	480	537	592
φ250	φ45	370.5	208±0.25	130	176	50	35	325	Rc2	106	300	200	606	250	335	65	541	607	672

● Allowance of B is h8, allowance of MM is f8.

With boots

Bore		φ32	φ40	φ50	φ63	φ80	φ100	φ125	φ140	φ150	φ160	φ180	φ200	φ224	φ250
Symbol	Rod B	40	50	63	71	80	100	125	125	140	140	160	180	180	200
	Rod C	—	50	50	63	71	80	100	125	125	125	125	140	160	180
X	Rod B	45	45	45	55	55	55	65	65	65	65	65	65	80	80
	Rod C	—	45	45	55	55	55	65	65	65	65	65	65	80	80

70-140H-8/TH8 Bore B CAD/DATA is available.



### FA For 7 MPa

70H-8 1 FA Bore B B Stroke - A B

For the rod dia. of  $\phi 100$  or more, a drill hole will be applied.

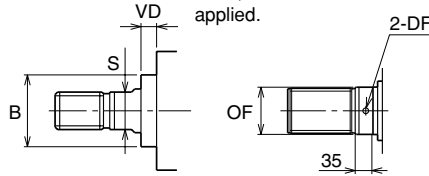

Rod dia.	OF	DF
$\phi 100$	$\phi 99.5$	$\phi 12$
$\phi 112$	$\phi 111.5$	$\phi 15$
$\phi 125$	$\phi 124.5$	$\phi 15$
$\phi 140$	$\phi 139.5$	$\phi 15$

General purpose hydraulic cylinder

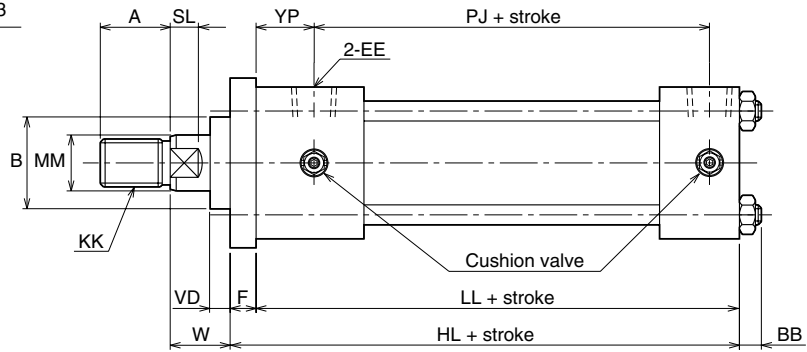
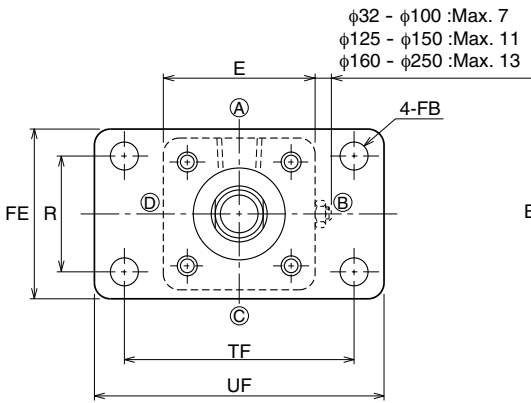

- For the dimensions other than in the diagram above, refer to the specification of the SD type (standard type).
- For the mounting of switches, refer to the dimensional drawings of "Switch set". All the contents other than "Switch mounting dimensions" are identical.
- If the port's sizes are greater than 1 inch, we recommend you to order G thread or pipe flange. Please feel free to contact us. (Order made)

### Double rod type ( $\phi 32 - \phi 250$ /rod B, C) For both ends loaded type

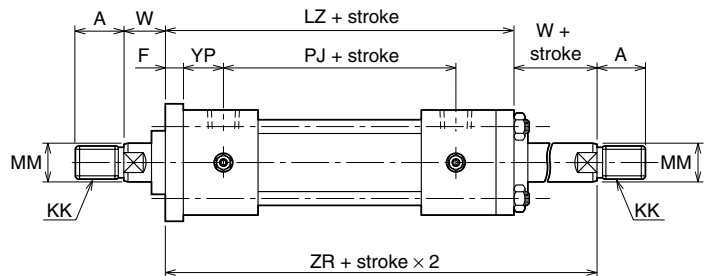

- The switch set ( $\phi 32 - \phi 140$ ) is also within the fabrication range.

### With boots

70-140H-8/TH8 Bore K

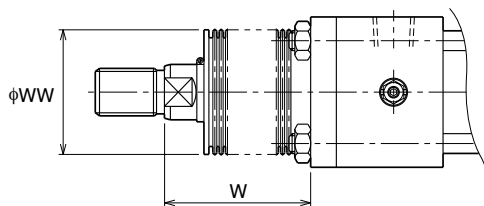

Rod B • C Nylon tarpaulin Chloroprene	$\phi 32$	1/3	Stroke + X
	$\phi 40 \cdot \phi 50$	1/3.5	Stroke + X
	$\phi 63 - \phi 100$	1/4	Stroke + X
	$\phi 125 - \phi 200$	1/5	Stroke + X
	$\phi 224 - \phi 250$	1/6	Stroke + X
Conex	$\phi 32$	1/2	Stroke + X
	$\phi 40 \cdot \phi 50$	1/2.5	Stroke + X
	$\phi 63 - \phi 100$	1/3	Stroke + X
	$\phi 125 \cdot \phi 140$	1/3.5	Stroke + X
	$\phi 150 - \phi 200$	1/4	Stroke + X
	$\phi 224 \cdot \phi 250$	1/4.5	Stroke + X

	Standard	Semi-standard	
<b>Material</b>	Nylon tarpaulin	Chloroprene	Conex
<b>Resistible temperature</b>	80°C	130°C	200°C

- (Notes)
- Remember that the resistible temperatures shown in the table above are for the boots, not for the cylinder.
  - Conex is the registered trademark of Teijin Ltd.
  - If decimals are included into the calculation results, raise them to the next whole number.
  - The boots have been mounted at our factory prior to delivery.

# 7/14 MPa double acting hydraulic cylinder

## Double acting single rod/double rod

Unit: mm

# 70/140H-8

58

### Dimensional table

Symbol Bore	Rod B							Rod C						
	A	B	KK	MM	S	SL	VD	A	B	KK	MM	S	SL	VD
φ32	25	φ34	M16×1.5	φ18	14	10	10	–	–	–	–	–	–	–
φ40	30	φ40	M20×1.5	φ22.4	19	11	10	25	φ36	M16×1.5	φ18	14	10	10
φ50	35	φ46	M24×1.5	φ28	24	14	10	30	φ40	M20×1.5	φ22.4	19	11	10
φ63	45	φ55	M30×1.5	φ35.5	30	16	10	35	φ46	M24×1.5	φ28	24	14	10
φ80	60	φ65	M39×1.5	φ45	41	20	10	45	φ55	M30×1.5	φ35.5	30	16	9
φ100	75	φ80	M48×1.5	φ56	50	23	10	60	φ65	M39×1.5	φ45	41	20	10
φ125	95	φ95	M64×2	φ71	65	27	10	75	φ80	M48×1.5	φ56	50	23	10
φ140	110	φ105	M72×2	φ80	75	31	10	80	φ85	M56×2	φ63	55	24	10
φ150	115	φ110	M76×2	φ85	80	33	10	85	φ90	M60×2	φ67	60	30	10
φ160	120	φ115	M80×2	φ90	85	33	10	95	φ95	M64×2	φ71	65	27	10
φ180	140	φ125	M95×2	φ100	–	Drill hole	10	110	φ105	M72×2	φ80	75	31	10
φ200	150	φ140	M100×2	φ112	–	Drill hole	10	120	φ115	M80×2	φ90	85	33	10
φ224	180	φ150	M120×2	φ125	–	Drill hole	10	140	φ125	M95×2	φ100	–	Drill hole	10
φ250	195	φ170	M130×2	φ140	–	Drill hole	10	150	φ140	M100×2	φ112	–	Drill hole	10

Symbol Bore	BB	E	EE	F	FB	FE	HL	LL	LZ	PJ	R	TF	UF	W	YP	ZR
φ32	11	□58	Rc 3/8	11	φ11	62	141	130	166	90	40	88	109	30	27	196
φ40	11	□65	Rc 3/8	11	φ11	69	141	130	166	90	46	95	118	30	27	196
φ50	11	□76	Rc 1/2	13	φ14	85	155	142	182	98	58	115	145	30	29	212
φ63	13	□90	Rc 1/2	15	φ18	98	163	148	194	102	65	132	165	35	31	229
φ80	16	□110	Rc 3/4	18	φ18	118	184	166	222	110	87	155	190	35	38	257
φ100	18	□135	Rc 3/4	20	φ22	150	192	172	232	116	109	190	230	40	38	272
φ125	21	□165	Rc 1	24	φ26	175	220	196	264	130	130	224	272	45	43	309
φ140	22	□185	Rc 1	26	φ26	195	230	204	276	138	145	250	300	50	43	326
φ150	25	□196	Rc 1	28	φ30	210	240	212	288	146	155	270	320	50	43	338
φ160	25	□210	Rc 1	31	φ33	225	253	222	304	156	170	285	345	55	43	359
φ180	27	□235	Rc 1 1/4	33	φ33	243	275	242	322	172	185	315	375	55	42	377
φ200	29	□262	Rc 1 1/2	37	φ36	272	301	264	354	184	206	355	425	55	48	409
φ224	34	□292	Rc 1 1/2	41	φ42	310	305	264	362	184	230	395	475	60	48	422
φ250	37	□325	Rc 2	46	φ45	335	346	300	412	200	250	425	515	65	60	477

• Allowance of B is h8, allowance of MM is f8.

### With boots

Symbol	Bore	φ32	φ40	φ50	φ63	φ80	φ100	φ125	φ140	φ150	φ160	φ180	φ200	φ224	φ250
	WW	Rod B	40	50	63	71	80	100	125	125	140	140	160	180	180
Rod C		–	50	50	63	71	80	100	125	125	125	125	140	160	180
X	Rod B	45	45	45	55	55	55	65	65	65	65	65	65	80	80
	Rod C	–	45	45	55	55	55	65	65	65	65	65	65	80	80

### FK

70H-8	1	FK	Bore	B	B	Stroke	-	A	B
140H-8	1	FK	Bore	B	B	Stroke	-	A	B

General purpose hydraulic cylinder

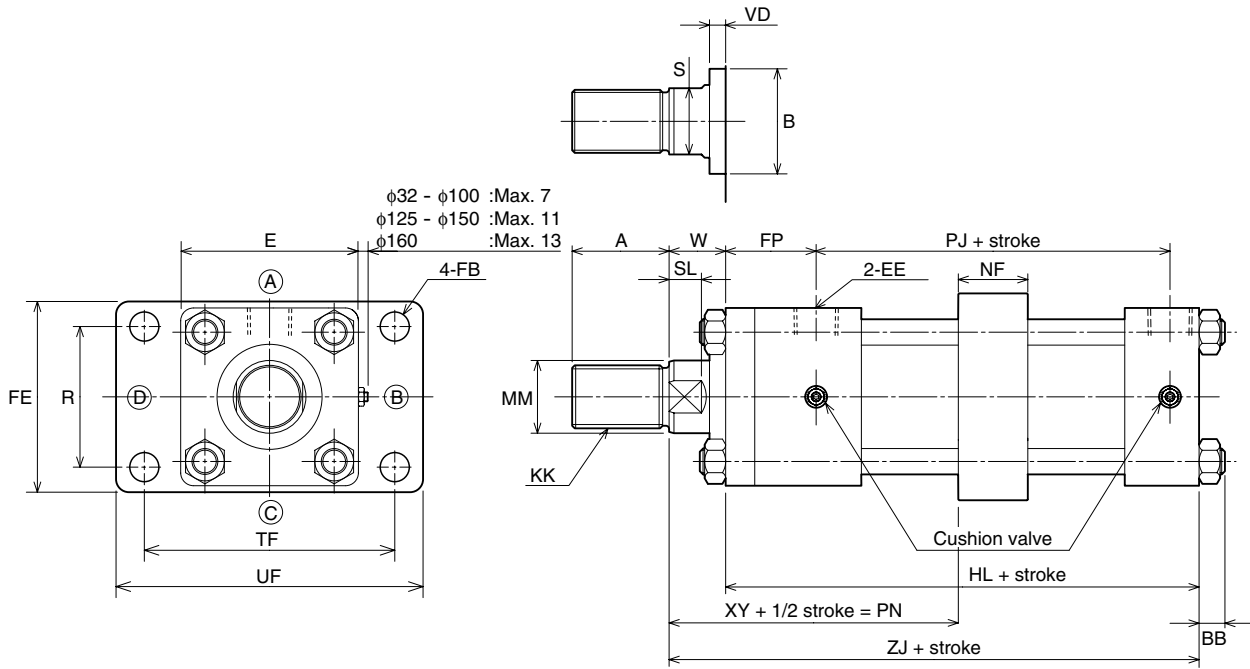

- For the dimensions other than in the diagram above, refer to the specification of the SD type (standard type).
- For the mounting of switches, refer to the dimensional drawings of "Switch set". All the contents other than "Switch mounting dimensions" are identical.

### With boots

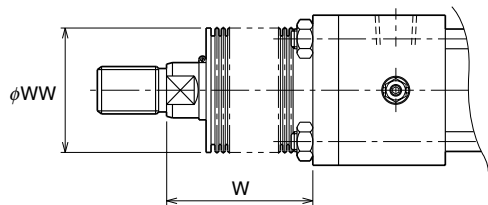

Rod B • C Nylon tarpaulin Chloroprene	$\phi 32$	1/3	Stroke + X
	$\phi 40$ • $\phi 50$	1/3.5	Stroke + X
	$\phi 63$ - $\phi 100$	1/4	Stroke + X
	$\phi 125$ - $\phi 160$	1/5	Stroke + X
Conex	$\phi 32$	1/2	Stroke + X
	$\phi 40$ • $\phi 50$	1/2.5	Stroke + X
	$\phi 63$ - $\phi 100$	1/3	Stroke + X
	$\phi 125$ • $\phi 140$	1/3.5	Stroke + X
	$\phi 150$ - $\phi 160$	1/4	Stroke + X

	Standard	Semi-standard	
<b>Material</b>	Nylon tarpaulin	Chloroprene	Conex
<b>Resistible temperature</b>	80°C	130°C	200°C

- Notes)
- Remember that the resistible temperatures shown in the table above are for the boots, not for the cylinder.
  - Conex is the registered trademark of Teijin Ltd.
  - If decimals are included into the calculation results, raise them to the next whole number.
  - The boots have been mounted at our factory prior to delivery.

Rod A Nylon tarpaulin Chloroprene	$\phi 40$	1/3.5	Stroke + X
	$\phi 50$ - $\phi 80$	1/4	Stroke + X
	$\phi 100$ - $\phi 160$	1/5	Stroke + X
Conex	$\phi 40$	1/2.5	Stroke + X
	$\phi 50$ - $\phi 80$	1/3	Stroke + X
	$\phi 100$	1/3.5	Stroke + X
	$\phi 125$ - $\phi 160$	1/4	Stroke + X

# 7/14 MPa double acting hydraulic cylinder

## Double acting single rod/double rod

Unit: mm

# 70/140H-8

60

### Dimensional table

Symbol Bore	Rod B							Rod C							Rod A							
	A	B	KK	MM	S	SL	VD	A	B	KK	MM	S	SL	VD	A	B	KK	MM	S	SL	VD	
φ32	25	φ34	M16×1.5	φ18	14	10	10	—	—	—	—	—	—	—	—	—	—	—	—	—	—	—
φ40	30	φ40	M20×1.5	φ22.4	19	11	10	25	φ36	M16×1.5	φ18	14	10	10	35	φ43	M24×1.5	φ28	24	14	17	17
φ50	35	φ46	M24×1.5	φ28	24	14	10	30	φ40	M20×1.5	φ22.4	19	11	10	45	φ50	M30×1.5	φ35.5	30	16	17	17
φ63	45	φ55	M30×1.5	φ35.5	30	16	10	35	φ46	M24×1.5	φ28	24	14	10	60	φ65	M39×1.5	φ45	41	20	19	19
φ80	60	φ65	M39×1.5	φ45	41	20	10	45	φ55	M30×1.5	φ35.5	30	16	9	75	φ80	M48×1.5	φ56	50	23	20	20
φ100	75	φ80	M48×1.5	φ56	50	23	10	60	φ65	M39×1.5	φ45	41	20	10	95	φ95	M64×2	φ71	65	27	23	23
φ125	95	φ95	M64×2	φ71	65	27	10	75	φ80	M48×1.5	φ56	50	23	10	120	φ115	M80×2	φ90	85	33	17	17
φ140	110	φ105	M72×2	φ80	75	31	10	80	φ85	M56×2	φ63	55	24	10	140	φ125	M95×2	φ100	—	Drill hole	17	17
φ150	115	φ110	M76×2	φ85	80	33	10	85	φ90	M60×2	φ67	60	30	10	140	φ125	M95×2	φ100	—	Drill hole	15	15
φ160	120	φ115	M80×2	φ90	85	33	10	95	φ95	M64×2	φ71	65	27	10	150	φ140	M100×2	φ112	—	Drill hole	16	16

Symbol Bore	BB	E	EE	FB	FE	FP	HL	NF	PJ	Minimum PN	R	TF	UF	W		XY		ZJ	
														B·C	A	B·C	A	B·C	A
φ32	11	□58	Rc3/8	φ11	62	38	141	28	90	91	40	88	109	30	—	99	—	171	—
φ40	11	□65	Rc3/8	φ11	69	38	141	28	90	91	46	95	118	30	35	99	104	171	176
φ50	11	□76	Rc1/2	φ14	85	42	155	33	98	97	58	115	145	30	41	104.5	115.5	185	196
φ63	13	□90	Rc1/2	φ18	98	46	163	43	102	106	65	132	165	35	48	110.5	123.5	198	211
φ80	16	□110	Rc3/4	φ18	118	56	184	43	110	119	87	155	190	35	51	124.5	140.5	219	235
φ100	18	□135	Rc3/4	φ22	150	58	192	53	116	126	109	190	230	40	57	129.5	146.5	232	249
φ125	21	□165	Rc1	φ26	175	67	220	58	130	145	130	224	272	45	57	148	160	265	277
φ140	22	□185	Rc1	φ26	195	69	230	78	138	152	145	250	300	50	57	149	156	280	287
φ150	25	□196	Rc1	φ30	210	71	240	78	146	154	155	270	320	50	57	155	162	290	297
φ160	25	□210	Rc1	φ33	225	74	253	88	156	167	170	285	345	55	57	163	165	308	310

• Allowance of B is h8, allowance of MM is f8.

### With boots

Bore		φ32	φ40	φ50	φ63	φ80	φ100	φ125	φ140	φ150	φ160
Symbol	Rod B	40	50	63	71	80	100	125	125	140	140
	Rod C	—	50	50	63	71	80	100	125	125	125
	Rod A	—	63	71	80	100	125	140	160	160	180
X	Rod B	45	45	45	55	55	55	65	65	65	65
	Rod C	—	45	45	55	55	55	65	65	65	65
	Rod A	—	45	55	55	55	65	65	65	65	65

General purpose hydraulic cylinder

70-140H-8/TH8 Bore B CAD/DATA is available.



### FB For 7 MPa

70H-8 1 FB Bore B B Stroke - A B

For the rod dia. of  $\phi 100$  or more, a drill hole will be applied.

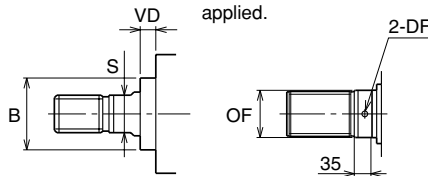

Rod dia.	OF	DF
$\phi 100$	$\phi 99.5$	$\phi 12$
$\phi 112$	$\phi 111.5$	$\phi 15$
$\phi 125$	$\phi 124.5$	$\phi 15$
$\phi 140$	$\phi 139.5$	$\phi 15$

General purpose hydraulic cylinder

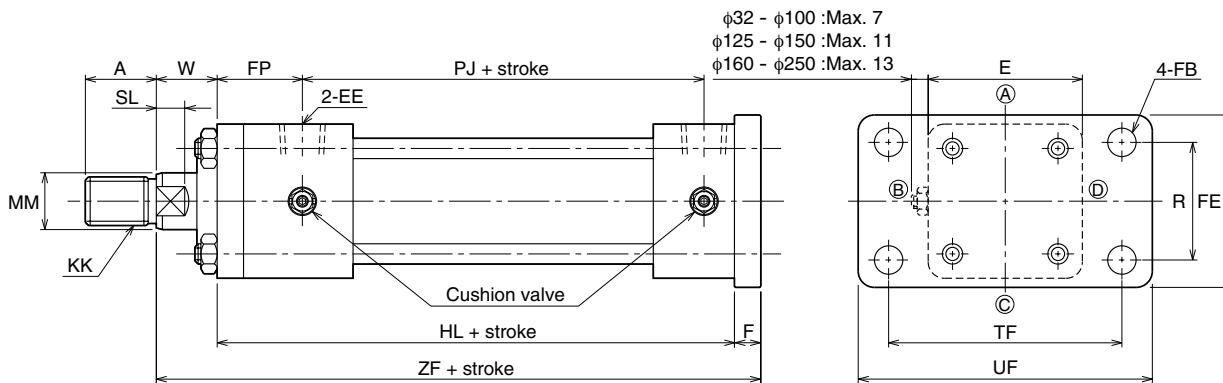

- For the dimensions other than in the diagram above, refer to the specification of the SD type (standard type).
- For the mounting of switches, refer to the dimensional drawings of "Switch set". All the contents other than "Switch mounting dimensions" are identical.
- If the port's sizes are greater than 1 inch, we recommend you to order G thread or pipe flange. Please feel free to contact us. (Order made)

### Double rod type ( $\phi 32 - \phi 250$ /rod B, C)

#### For both ends loaded type

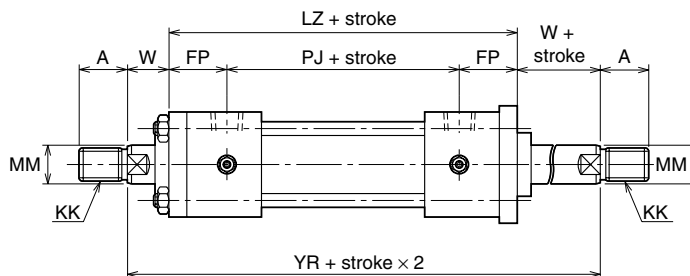

- The switch set ( $\phi 32 - \phi 140$ ) is also within the fabrication range.

### With boots

70-140H-8/TH8 Bore K

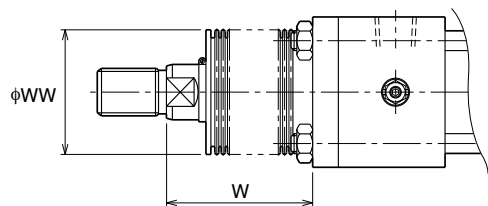

Material	Rod dia.	Stroke	Stroke + X
Nylon tarpaulin Chloroprene	$\phi 32$	1/3	Stroke + X
	$\phi 40 - \phi 50$	1/3.5	Stroke + X
	$\phi 63 - \phi 100$	1/4	Stroke + X
	$\phi 125 - \phi 200$	1/5	Stroke + X
	$\phi 224 - \phi 250$	1/6	Stroke + X
Conex	$\phi 32$	1/2	Stroke + X
	$\phi 40 - \phi 50$	1/2.5	Stroke + X
	$\phi 63 - \phi 100$	1/3	Stroke + X
	$\phi 125 - \phi 140$	1/3.5	Stroke + X
	$\phi 150 - \phi 200$	1/4	Stroke + X
	$\phi 224 - \phi 250$	1/4.5	Stroke + X

	Standard	Semi-standard	
<b>Material</b>	Nylon tarpaulin	Chloroprene	Conex
<b>Resistible temperature</b>	80°C	130°C	200°C

- (Notes)
- Remember that the resistible temperatures shown in the table above are for the boots, not for the cylinder.
  - Conex is the registered trademark of Teijin Ltd.
  - If decimals are included into the calculation results, raise them to the next whole number.
  - The boots have been mounted at our factory prior to delivery.

# 7/14 MPa double acting hydraulic cylinder

## Double acting single rod/double rod

Unit: mm

# 70/140H-8

62

### Dimensional table

Symbol Bore	Rod B							Rod C						
	A	B	KK	MM	S	SL	VD	A	B	KK	MM	S	SL	VD
φ32	25	φ34	M16×1.5	φ18	14	10	10	—	—	—	—	—	—	—
φ40	30	φ40	M20×1.5	φ22.4	19	11	10	25	φ36	M16×1.5	φ18	14	10	10
φ50	35	φ46	M24×1.5	φ28	24	14	10	30	φ40	M20×1.5	φ22.4	19	11	10
φ63	45	φ55	M30×1.5	φ35.5	30	16	10	35	φ46	M24×1.5	φ28	24	14	10
φ80	60	φ65	M39×1.5	φ45	41	20	10	45	φ55	M30×1.5	φ35.5	30	16	9
φ100	75	φ80	M48×1.5	φ56	50	23	10	60	φ65	M39×1.5	φ45	41	20	10
φ125	95	φ95	M64×2	φ71	65	27	10	75	φ80	M48×1.5	φ56	50	23	10
φ140	110	φ105	M72×2	φ80	75	31	10	80	φ85	M56×2	φ63	55	24	10
φ150	115	φ110	M76×2	φ85	80	33	10	85	φ90	M60×2	φ67	60	30	10
φ160	120	φ115	M80×2	φ90	85	33	10	95	φ95	M64×2	φ71	65	27	10
φ180	140	φ125	M95×2	φ100	—	Drill hole	10	110	φ105	M72×2	φ80	75	31	10
φ200	150	φ140	M100×2	φ112	—	Drill hole	10	120	φ115	M80×2	φ90	85	33	10
φ224	180	φ150	M120×2	φ125	—	Drill hole	10	140	φ125	M95×2	φ100	—	Drill hole	10
φ250	195	φ170	M130×2	φ140	—	Drill hole	10	150	φ140	M100×2	φ112	—	Drill hole	10

Symbol Bore	E	EE	F	FB	FE	FP	HL	LZ	PJ	R	TF	UF	W	YR	ZF
φ32	□58	Rc 3/8	11	φ11	62	38	141	166	90	40	88	109	30	226	182
φ40	□65	Rc 3/8	11	φ11	69	38	141	166	90	46	95	118	30	226	182
φ50	□76	Rc 1/2	13	φ14	85	42	155	182	98	58	115	145	30	242	198
φ63	□90	Rc 1/2	15	φ18	98	46	163	194	102	65	132	165	35	264	213
φ80	□110	Rc 3/4	18	φ18	118	56	184	222	110	87	155	190	35	292	237
φ100	□135	Rc 3/4	20	φ22	150	58	192	232	116	109	190	230	40	312	252
φ125	□165	Rc 1	24	φ26	175	67	220	264	130	130	224	272	45	354	289
φ140	□185	Rc 1	26	φ26	195	69	230	276	138	145	250	300	50	376	306
φ150	□196	Rc 1	28	φ30	210	71	240	288	146	155	270	320	50	388	318
φ160	□210	Rc 1	31	φ33	225	74	253	304	156	170	285	345	55	414	339
φ180	□235	Rc 1 1/4	33	φ33	243	75	275	322	172	185	315	375	55	432	363
φ200	□262	Rc 1 1/2	37	φ36	272	85	301	354	184	206	355	425	55	464	393
φ224	□292	Rc 1 1/2	41	φ42	310	89	305	362	184	230	395	475	60	482	406
φ250	□325	Rc 2	46	φ45	335	106	346	412	200	250	425	515	65	542	457

• Allowance of B is h8, allowance of MM is f8.

### With boots

Bore		φ32	φ40	φ50	φ63	φ80	φ100	φ125	φ140	φ150	φ160	φ180	φ200	φ224	φ250
WW	Rod B	40	50	63	71	80	100	125	125	140	140	160	180	180	200
	Rod C	—	50	50	63	71	80	100	125	125	125	125	140	160	180
X	Rod B	45	45	45	55	55	55	65	65	65	65	65	65	80	80
	Rod C	—	45	45	55	55	55	65	65	65	65	65	65	80	80

General purpose hydraulic cylinder

70-140H-8/TH8 Bore C CAD/DATA is available.**FE** For rod A

70H-8	1	FE	Bore	A	B	Stroke	-	A	B
140H-8	1	FE	Bore	A	B	Stroke	-	A	B

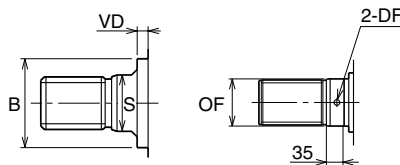
For the rod dia. of  $\phi 100$  or more, a drill hole will be applied.

Rod dia.	OF	DF
$\phi 100$	$\phi 99.5$	$\phi 12$
$\phi 112$	$\phi 111.5$	$\phi 15$

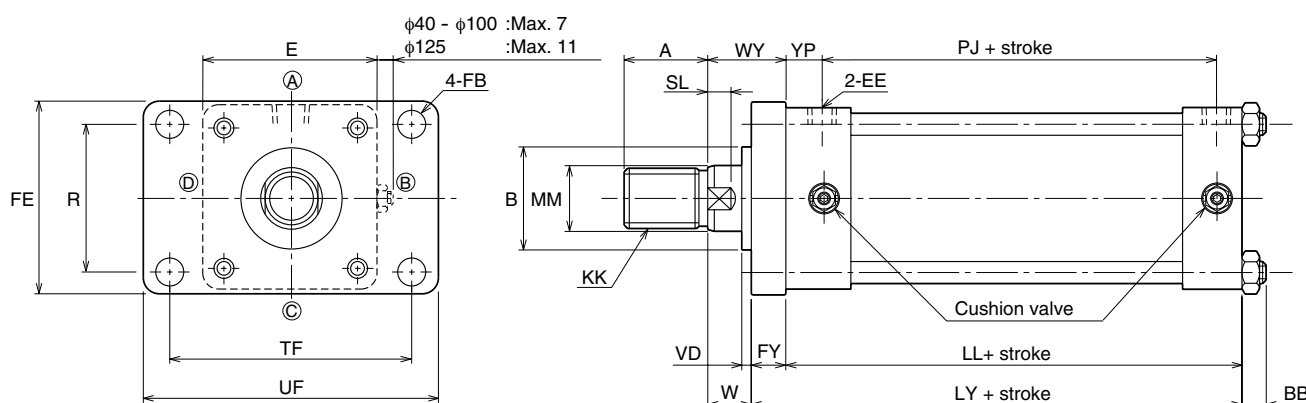

- For the dimensions other than in the diagram above, refer to the specification of the SD type (standard type).

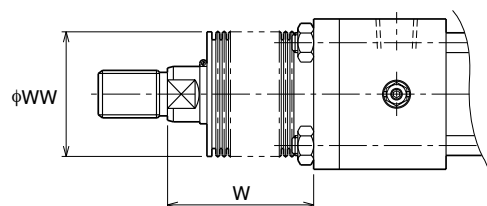
**With boots**70-140H-8/TH8 Bore K 

Nylon tarpaulin Chloroprene	( Rod A		
	$\phi 40$	1/3.5	Stroke + X
	$\phi 50 - \phi 80$	1/4	Stroke + X
	$\phi 100 - \phi 160$	1/5	Stroke + X
Conex	( Rod A		
	$\phi 40$	1/2.5	Stroke + X
	$\phi 50 - \phi 80$	1/3	Stroke + X
	$\phi 100$	1/3.5	Stroke + X
	$\phi 125 - \phi 160$	1/4	Stroke + X

	Standard	Semi-standard	
<b>Material</b>	Nylon tarpaulin	Chloroprene	Conex
<b>Resistible temperature</b>	80°C	130°C	200°C

- Notes) • Remember that the resistible temperatures shown in the table above are for the boots, not for the cylinder.
- Conex is the registered trademark of Teijin Ltd.
  - If decimals are included into the calculation results, raise them to the next whole number.
  - The boots have been mounted at our factory prior to delivery.



Dimensional table

Symbol	Rod A							BB	E	EE	FB	FE	FY	LL	LY	PJ	R	TF	UF	W	WY	YP
	A	B	KK	MM	S	SL	VD															
φ40	35	φ43	M24×1.5	φ28	24	14	10	11	□65	Rc 3/8	φ11	69	18	130	148	90	46	95	118	35	53	27
φ50	45	φ50	M30×1.5	φ35.5	30	16	10	11	□76	Rc 1/2	φ14	85	20	142	162	98	58	115	145	41	61	29
φ63	60	φ65	M39×1.5	φ45	41	20	10	13	□90	Rc 1/2	φ18	98	24	148	172	102	65	132	165	48	72	31
φ80	75	φ80	M48×1.5	φ56	50	23	8	16	□110	Rc 3/4	φ18	118	30	166	196	110	87	155	190	51	81	38
φ100	95	φ95	M64×2	φ71	65	27	11	18	□135	Rc 3/4	φ22	150	32	172	204	116	109	190	230	57	89	38
φ125	120	φ115	M80×2	φ90	85	30	10	21	□165	Rc1	φ26	175	41	196	237	130	130	224	272	57	98	43
φ140	140	φ125	M95×2	φ100	—	Drill hole	13	22	□185	Rc1	φ26	195	43	204	247	138	145	250	300	57	100	43
φ150	140	φ125	M95×2	φ100	—	Drill hole	13	25	□196	Rc1	φ30	210	43	212	255	146	155	270	320	57	100	43
φ160	150	φ140	M100×2	φ112	—	Drill hole	15	25	□210	Rc1	φ33	225	46	222	268	156	170	285	345	57	103	43

• Allowance of B is h8, allowance of MM is f8.

With boots

Bore		φ40	φ50	φ63	φ80	φ100	φ125	φ140	φ150	φ160
WW	Rod A	63	71	80	100	125	140	160	160	180
X	Rod A	45	55	55	55	65	65	65	65	65

70-140H-8/TH8 Bore B CAD/DATA is available.



### FY

70H-8	1	FY	Bore	B	B	Stroke	-	A	B
140H-8	1	FY	Bore	B	B	Stroke	-	A	B

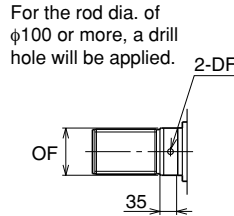

Rod dia.	OF	DF
φ100	φ99.5	φ12
φ112	φ111.5	φ15
φ125	φ124.5	φ15
φ140	φ139.5	φ15

General purpose hydraulic cylinder

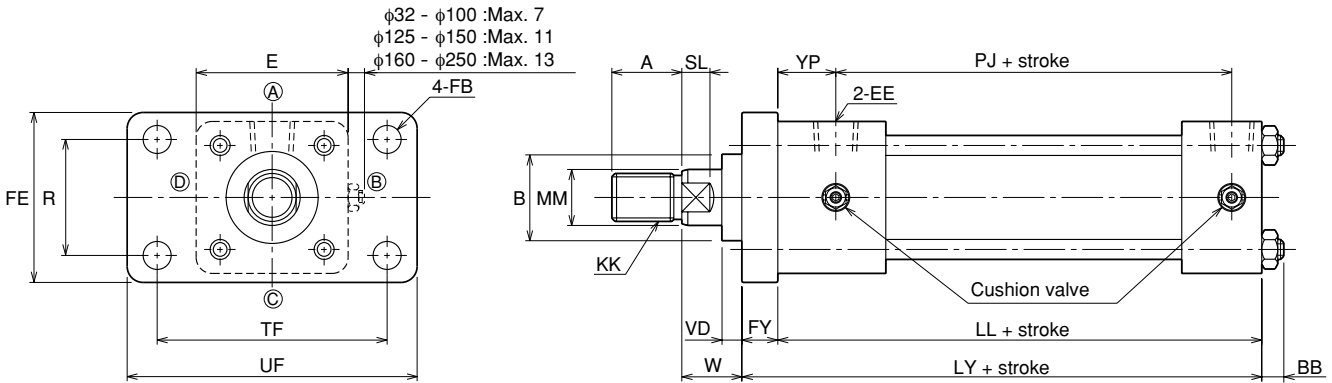

- For the dimensions other than in the diagram above, refer to the specification of the SD type (standard type).
- For the mounting of switches, refer to the dimensional drawings of "Switch set". All the contents other than "Switch mounting dimensions" are identical.
- If the port's sizes are greater than 1 inch, we recommend you to order G thread or pipe flange. Please feel free to contact us. (Order made)

### Double rod type (φ32 - φ250/rod B, C) For both ends loaded type

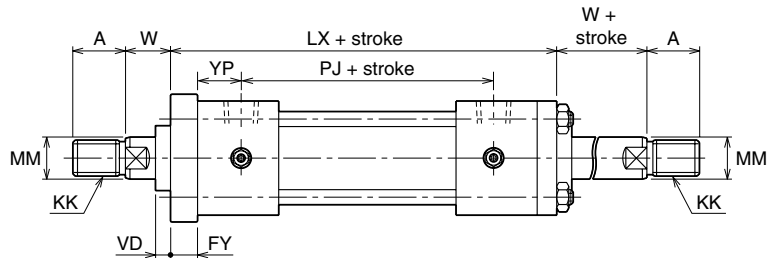

- The switch set (φ32 - φ140) is also within the fabrication range.

### With boots

70-140H-8/TH8 Bore K

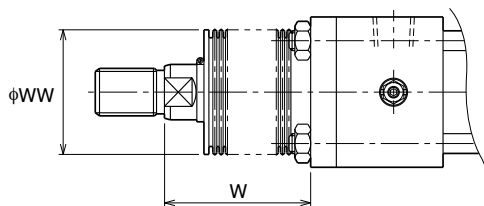

Material	Port Size	Stroke	Stroke + X
Nylon tarpaulin Chloroprene	φ32	1/3	Stroke + X
	φ40 • φ50	1/3.5	Stroke + X
	φ63 - φ100	1/4	Stroke + X
	φ125 - φ200	1/5	Stroke + X
	φ224 • φ250	1/6	Stroke + X
Conex	φ32	1/2	Stroke + X
	φ40 • φ50	1/2.5	Stroke + X
	φ63 - φ100	1/3	Stroke + X
	φ125 • φ140	1/3.5	Stroke + X
	φ150 - φ200	1/4	Stroke + X
	φ224 • φ250	1/4.5	Stroke + X

	Standard	Semi-standard	
<b>Material</b>	Nylon tarpaulin	Chloroprene	Conex
<b>Resistible temperature</b>	80°C	130°C	200°C

- Notes)
- Remember that the resistible temperatures shown in the table above are for the boots, not for the cylinder.
  - Conex is the registered trademark of Teijin Ltd.
  - If decimals are included into the calculation results, raise them to the next whole number.
  - The boots have been mounted at our factory prior to delivery.

# 7/14 MPa double acting hydraulic cylinder

## Double acting single rod/double rod

Unit: mm

# 70/140H-8

66

### Dimensional table

Symbol Bore	Rod B							Rod C						
	A	B	KK	MM	S	SL	VD	A	B	KK	MM	S	SL	VD
φ32	25	φ34	M16×1.5	φ18	14	10	10	–	–	–	–	–	–	–
φ40	30	φ40	M20×1.5	φ22.4	19	11	10	25	φ36	M16×1.5	φ18	14	10	10
φ50	35	φ46	M24×1.5	φ28	24	14	10	30	φ40	M20×1.5	φ22.4	19	11	10
φ63	45	φ55	M30×1.5	φ35.5	30	16	10	35	φ46	M24×1.5	φ28	24	14	10
φ80	60	φ65	M39×1.5	φ45	41	20	10	45	φ55	M30×1.5	φ35.5	30	16	10
φ100	75	φ80	M48×1.5	φ56	50	23	10	60	φ65	M39×1.5	φ45	41	20	10
φ125	95	φ95	M64×2	φ71	65	27	10	75	φ80	M48×1.5	φ56	50	23	10
φ140	110	φ105	M72×2	φ80	75	31	10	80	φ85	M56×2	φ63	55	24	10
φ150	115	φ110	M76×2	φ85	80	33	10	85	φ90	M60×2	φ67	60	30	10
φ160	120	φ115	M80×2	φ90	85	33	10	95	φ95	M64×2	φ71	65	27	10
φ180	140	φ125	M95×2	φ100	–	Drill hole	10	110	φ105	M72×2	φ80	75	31	10
φ200	150	φ140	M100×2	φ112	–	Drill hole	10	120	φ115	M80×2	φ90	85	33	10
φ224	180	φ150	M120×2	φ125	–	Drill hole	10	140	φ125	M95×2	φ100	–	Drill hole	10
φ250	195	φ170	M130×2	φ140	–	Drill hole	10	150	φ140	M100×2	φ112	–	Drill hole	10

Symbol Bore	BB	E	EE	FB	FE	FY	LL	LX	LY	PJ	R	TF	UF	W	YP
φ32	11	□58	Rc 3/8	φ11	62	13	130	168	143	90	40	88	109	30	27
φ40	11	□65	Rc 3/8	φ11	69	13	130	168	143	90	46	95	118	30	27
φ50	11	□76	Rc 1/2	φ14	85	18	142	187	160	98	58	115	145	30	29
φ63	13	□90	Rc 1/2	φ18	98	20	148	199	168	102	65	132	165	35	31
φ80	16	□110	Rc 3/4	φ18	118	24	166	228	190	110	87	155	190	35	38
φ100	18	□135	Rc 3/4	φ22	150	28	172	240	200	116	109	190	230	40	38
φ125	21	□165	Rc 1	φ26	175	33	196	273	229	130	130	224	272	45	43
φ140	22	□185	Rc 1	φ26	195	37	204	287	241	138	145	250	300	50	43
φ150	25	□196	Rc 1	φ30	210	39	212	299	251	146	155	270	320	50	43
φ160	25	□210	Rc 1	φ33	225	41	222	314	263	156	170	285	345	55	43
φ180	27	□235	Rc 1 1/4	φ33	243	46	242	335	288	172	185	315	375	55	42
φ200	29	□262	Rc 1 1/2	φ36	272	51	264	368	315	184	206	355	425	55	48
φ224	34	□292	Rc 1 1/2	φ42	310	58	264	379	322	184	230	395	475	60	48
φ250	37	□325	Rc 2	φ45	335	65	300	431	365	200	250	425	515	65	60

• Allowance of B is h8, allowance of MM is f8.

### With boots

Symbol	Bore	φ32	φ40	φ50	φ63	φ80	φ100	φ125	φ140	φ150	φ160	φ180	φ200	φ224	φ250
	WW	Rod B	40	50	63	71	80	100	125	125	140	140	160	180	180
Rod C		–	50	50	63	71	80	100	125	125	125	125	140	160	180
X	Rod B	45	45	45	55	55	55	65	65	65	65	65	65	80	80
	Rod C	–	45	45	55	55	55	65	65	65	65	65	65	80	80

General purpose hydraulic cylinder

70-140H-8/TH8 Bore B.C CAD/DATA is available.



### FZ

70H-8	1	FZ	<span style="border: 1px solid black; padding: 2px;">Bore</span>	<span style="border: 1px solid black; padding: 2px;">B</span>	<span style="border: 1px solid black; padding: 2px;">B</span>	<span style="border: 1px solid black; padding: 2px;">Stroke</span>	-	<span style="border: 1px solid black; padding: 2px;">A</span>	<span style="border: 1px solid black; padding: 2px;">B</span>
140H-8	1	FZ	<span style="border: 1px solid black; padding: 2px;">Bore</span>	<span style="border: 1px solid black; padding: 2px;">B</span>	<span style="border: 1px solid black; padding: 2px;">B</span>	<span style="border: 1px solid black; padding: 2px;">Stroke</span>	-	<span style="border: 1px solid black; padding: 2px;">A</span>	<span style="border: 1px solid black; padding: 2px;">B</span>

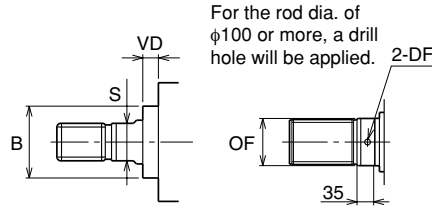

Rod dia.	OF	DF
φ100	φ99.5	φ12
φ112	φ111.5	φ15
φ125	φ124.5	φ15
φ140	φ139.5	φ15

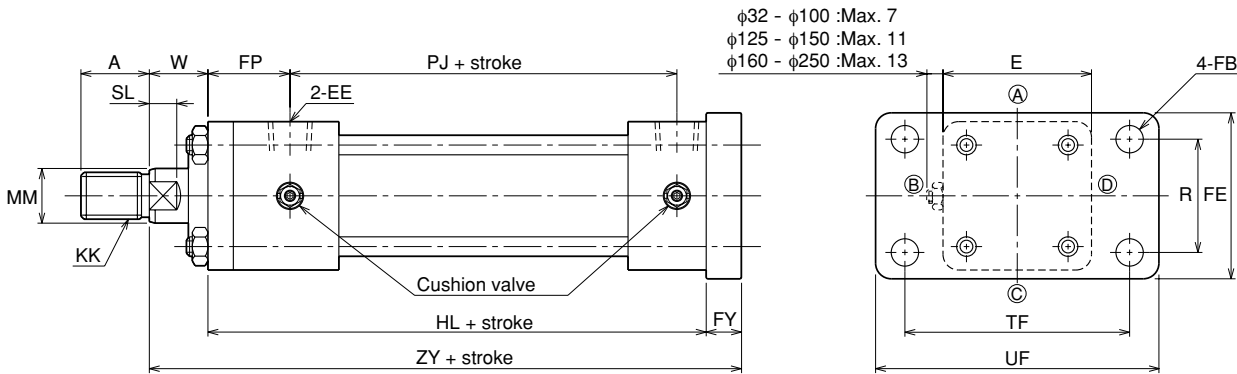

- For the dimensions other than in the diagram above, refer to the specification of the SD type (standard type).
- For the mounting of switches, refer to the dimensional drawings of "Switch set". All the contents other than "Switch mounting dimensions" are identical.
- If the port's sizes are greater than 1 inch, we recommend you to order G thread or pipe flange. Please feel free to contact us. (Order made)

### Double rod type (φ32 - φ250/rod B, C) For both ends loaded type

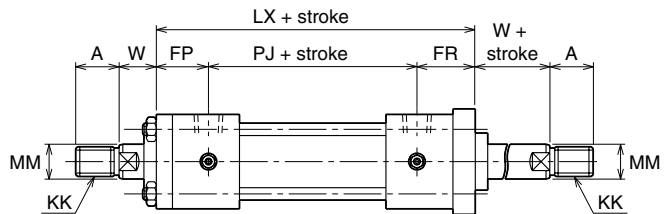

- The switch set (φ32 - φ140) is also within the fabrication range.

### With boots

70-140H-8/TH8 BoreK

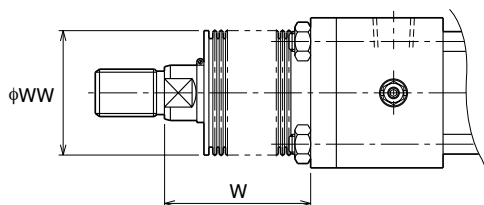

Material	Rod Dia.	Stroke	Stroke + X
Rod B • C Nylon tarpaulin Chloroprene	φ32	1/3	Stroke + X
	φ40 • φ50	1/3.5	Stroke + X
	φ63 - φ100	1/4	Stroke + X
	φ125 - φ200	1/5	Stroke + X
	φ224 • φ250	1/6	Stroke + X
Conex	φ32	1/2	Stroke + X
	φ40 • φ50	1/2.5	Stroke + X
	φ63 - φ100	1/3	Stroke + X
	φ125 • φ140	1/3.5	Stroke + X
	φ150 - φ200	1/4	Stroke + X
	φ224 • φ250	1/4.5	Stroke + X

	Standard	Semi-standard	
<b>Material</b>	Nylon tarpaulin	Chloroprene	Conex
<b>Resistible temperature</b>	80°C	130°C	200°C

Notes) • Remember that the resistible temperatures shown in the table above are for the boots, not for the cylinder.  
• Conex is the registered trademark of Teijin Ltd.  
• If decimals are included into the calculation results, raise them to the next whole number.  
• The boots have been mounted at our factory prior to delivery.

Material	Rod Dia.	Stroke	Stroke + X
Rod A Nylon tarpaulin Chloroprene	φ40	1/3.5	Stroke + X
	φ50 - φ80	1/4	Stroke + X
	φ100 - φ160	1/5	Stroke + X
Conex	φ40	1/2.5	Stroke + X
	φ50 - φ80	1/3	Stroke + X
	φ100	1/3.5	Stroke + X
	φ125 - φ160	1/4	Stroke + X

# 7/14 MPa double acting hydraulic cylinder

## Double acting single rod/double rod

Unit: mm

# 70/140H-8

### Dimensional table

Symbol Bore	Rod B							Rod C							Rod A						
	A	B	KK	MM	S	SL	VD	A	B	KK	MM	S	SL	VD	A	B	KK	MM	S	SL	VD
φ32	25	φ34	M16×1.5	φ18	14	10	10	—	—	—	—	—	—	—	—	—	—	—	—	—	—
φ40	30	φ40	M20×1.5	φ22.4	19	11	10	25	φ36	M16×1.5	φ18	14	10	10	35	φ43	M24×1.5	φ28	24	14	17
φ50	35	φ46	M24×1.5	φ28	24	14	10	30	φ40	M20×1.5	φ22.4	19	11	10	45	φ50	M30×1.5	φ35.5	30	16	17
φ63	45	φ55	M30×1.5	φ35.5	30	16	10	35	φ46	M24×1.5	φ28	24	14	10	60	φ65	M39×1.5	φ45	41	20	19
φ80	60	φ65	M39×1.5	φ45	41	20	10	45	φ55	M30×1.5	φ35.5	30	16	9	75	φ80	M48×1.5	φ56	50	23	20
φ100	75	φ80	M48×1.5	φ56	50	23	10	60	φ65	M39×1.5	φ45	41	20	10	95	φ95	M64×2	φ71	65	27	23
φ125	95	φ95	M64×2	φ71	65	27	10	75	φ80	M48×1.5	φ56	50	23	10	120	φ115	M80×2	φ90	85	30	17
φ140	110	φ105	M72×2	φ80	75	31	10	80	φ85	M56×2	φ63	55	24	10	140	φ125	M95×2	φ100	—	Drill hole	17
φ150	115	φ110	M76×2	φ85	80	33	10	85	φ90	M60×2	φ67	60	30	10	140	φ125	M95×2	φ100	—	Drill hole	15
φ160	120	φ115	M80×2	φ90	85	33	10	95	φ95	M64×2	φ71	65	27	10	150	φ140	M100×2	φ112	—	Drill hole	16
φ180	140	φ125	M95×2	φ100	—	Drill hole	10	110	φ105	M72×2	φ80	75	31	10	—	—	—	—	—	—	—
φ200	150	φ140	M100×2	φ112	—	Drill hole	10	120	φ115	M80×2	φ90	85	33	10	—	—	—	—	—	—	—
φ224	180	φ150	M120×2	φ125	—	Drill hole	10	140	φ125	M95×2	φ100	—	Drill hole	10	—	—	—	—	—	—	—
φ250	195	φ170	M130×2	φ140	—	Drill hole	10	150	φ140	M100×2	φ112	—	Drill hole	10	—	—	—	—	—	—	—

Symbol Bore	E	EE	FB	FE	FP	FR	FY	HL	LX	PJ	R	TF	UF	W		ZY	
														B·C	A	B·C	A
φ32	□58	Rc 3/8	φ11	62	38	40	13	141	168	90	40	88	109	30	—	184	—
φ40	□65	Rc 3/8	φ11	69	38	40	13	141	168	90	46	95	118	30	35	184	189
φ50	□76	Rc 1/2	φ14	85	42	47	18	155	187	98	58	115	145	30	41	203	214
φ63	□90	Rc 1/2	φ18	98	46	51	20	163	199	102	65	132	165	35	48	218	231
φ80	□110	Rc 3/4	φ18	118	56	62	24	184	228	110	87	155	190	35	51	243	259
φ100	□135	Rc 3/4	φ22	150	58	66	28	192	240	116	109	190	230	40	57	260	277
φ125	□165	Rc 1	φ26	175	67	76	33	220	273	130	130	224	272	45	57	298	310
φ140	□185	Rc 1	φ26	195	69	80	37	230	287	138	145	250	300	50	57	317	324
φ150	□196	Rc 1	φ30	210	71	82	39	240	299	146	155	270	320	50	57	329	336
φ160	□210	Rc 1	φ33	225	74	84	41	253	314	156	170	285	345	55	57	349	351
φ180	□235	Rc 1 1/4	φ33	243	75	88	46	275	335	172	185	315	375	55	—	376	—
φ200	□262	Rc 1 1/2	φ36	272	85	99	51	301	368	184	206	355	425	55	—	407	—
φ224	□292	Rc 1 1/2	φ42	310	89	106	58	305	379	184	230	395	475	60	—	423	—
φ250	□325	Rc 2	φ45	335	106	125	65	346	431	200	250	425	515	65	—	476	—

• Allowance of B is h8, allowance of MM is f8.

### With boots

Bore		φ32	φ40	φ50	φ63	φ80	φ100	φ125	φ140	φ150	φ160	φ180	φ200	φ224	φ250	
Symbol	WW	Rod B	40	50	63	71	80	100	125	125	140	140	160	180	180	200
	Rod C	—	50	50	63	71	80	140	125	125	125	125	140	160	180	
	Rod A	—	63	71	80	100	125	140	160	160	180	—	—	—	—	
X	Rod B	45	45	45	55	55	55	65	65	65	65	65	65	80	80	
	Rod C	—	45	45	55	55	55	65	65	65	65	65	65	80	80	
	Rod A	—	45	55	55	55	65	65	65	65	65	—	—	—	—	

General purpose hydraulic cylinder

70-140H-8/TH8 Bore B CAD/DATA is available.

## FC

70H-8 1 FC Bore B B Stroke - A B

140H-8 1 FC Bore B B Stroke - A B

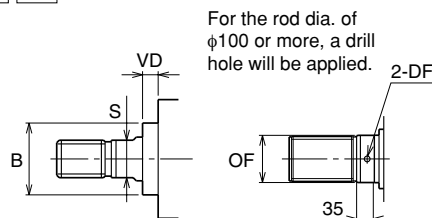

Rod dia.	OF	DF
φ100	φ99.5	φ12
φ112	φ111.5	φ15
φ125	φ124.5	φ15
φ140	φ139.5	φ15

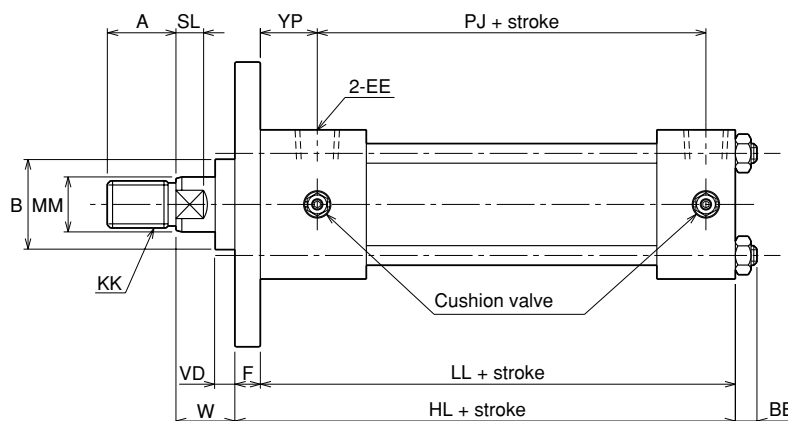
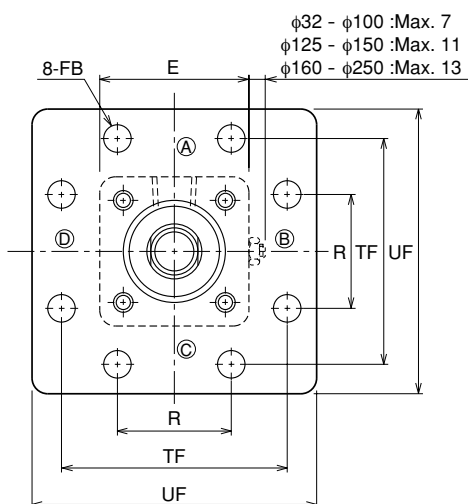

- For the dimensions other than in the diagram above, refer to the specification of the SD type (standard type).
- For the mounting of switches, refer to the dimensional drawings of "Switch set". All the contents other than "Switch mounting dimensions" are identical.
- If the port's sizes are greater than 1 inch, we recommend you to order G thread or pipe flange. Please feel free to contact us. (Order made)

## Double rod type (φ32 - φ250/rod B, C)

## For both ends loaded type

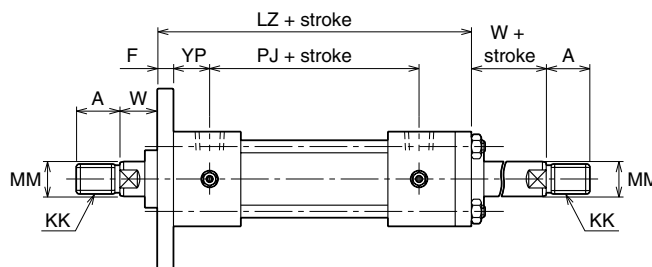

- The switch set (φ32 - φ140) is also within the fabrication range.

## With boots

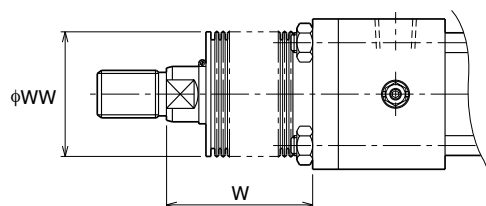
70-140H-8/TH8 Bore K 

Rod B · C Nylon tarpaulin Chloroprene	φ32	1/3	Stroke + X
	φ40 · φ50	1/3.5	Stroke + X
	φ63 - φ100	1/4	Stroke + X
	φ125 - φ200	1/5	Stroke + X
Conex	φ224 · φ250	1/6	Stroke + X
	φ32	1/2	Stroke + X
	φ40 · φ50	1/2.5	Stroke + X
	φ63 - φ100	1/3	Stroke + X
	φ125 · φ140	1/3.5	Stroke + X
	φ150 - φ200	1/4	Stroke + X
	φ224 · φ250	1/4.5	Stroke + X

	Standard	Semi-standard	
Material	Nylon tarpaulin	Chloroprene	Conex
Resistible temperature	80°C	130°C	200°C

(Notes) • Remember that the resistible temperatures shown in the table above are for the boots, not for the cylinder.

- Conex is the registered trademark of Teijin Ltd.
- If decimals are included into the calculation results, raise them to the next whole number.
- The boots have been mounted at our factory prior to delivery.



70-140H-8/TH8 Bore B CAD/DATA is available.

## FD

70H-8 1 FD Bore B B Stroke - A B

140H-8 1 FD Bore B B Stroke - A B

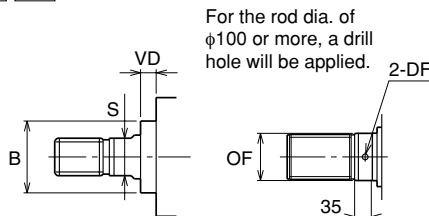
For the rod dia. of  $\phi 100$  or more, a drill hole will be applied.

Rod dia.	OF	DF
$\phi 100$	$\phi 99.5$	$\phi 12$
$\phi 112$	$\phi 111.5$	$\phi 15$
$\phi 125$	$\phi 124.5$	$\phi 15$
$\phi 140$	$\phi 139.5$	$\phi 15$

$\phi 32 - \phi 100$  :Max. 7  
 $\phi 125 - \phi 150$  :Max. 11  
 $\phi 160 - \phi 250$  :Max. 13

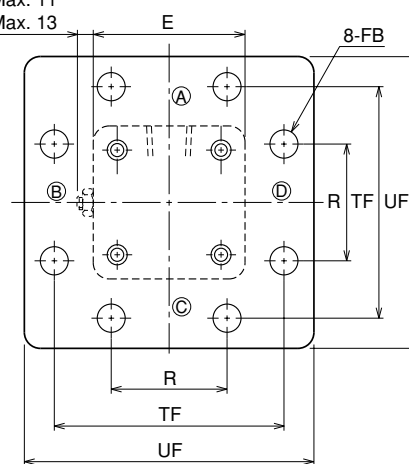
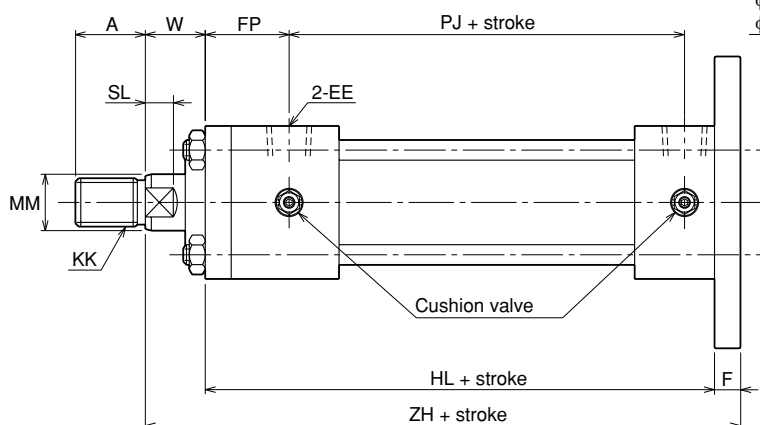

- For the dimensions other than in the diagram above, refer to the specification of the SD type (standard type).
- For the mounting of switches, refer to the dimensional drawings of "Switch set". All the contents other than "Switch mounting dimensions" are identical.
- If the port's sizes are greater than 1 inch, we recommend you to order G thread or pipe flange. Please feel free to contact us. (Order made)

Double rod type ( $\phi 32 - \phi 250$ /rod B, C)

## For both ends loaded type

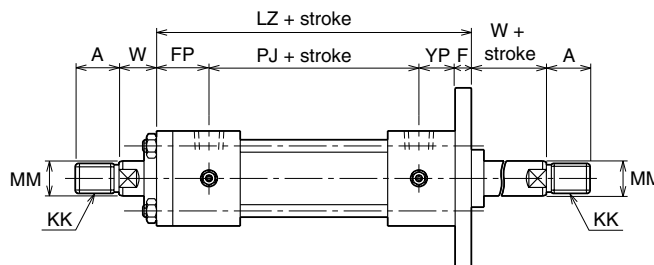

- The switch set ( $\phi 32 - \phi 140$ ) is also within the fabrication range.

## With boots

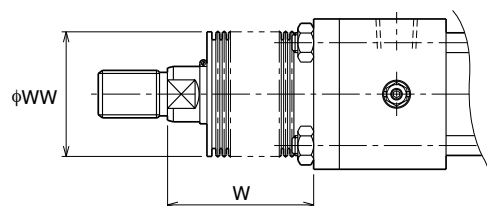
70-140H-8/TH8 Bore K

Rod B • C Nylon tarpaulin Chloroprene	$\phi 32$	1/3	Stroke + X
	$\phi 40 - \phi 50$	1/3.5	Stroke + X
	$\phi 63 - \phi 100$	1/4	Stroke + X
	$\phi 125 - \phi 200$	1/5	Stroke + X
	$\phi 224 - \phi 250$	1/6	Stroke + X
Conex	$\phi 32$	1/2	Stroke + X
	$\phi 40 - \phi 50$	1/2.5	Stroke + X
	$\phi 63 - \phi 100$	1/3	Stroke + X
	$\phi 125 - \phi 140$	1/3.5	Stroke + X
	$\phi 150 - \phi 200$	1/4	Stroke + X
	$\phi 224 - \phi 250$	1/4.5	Stroke + X

	Standard	Semi-standard	
Material	Nylon tarpaulin	Chloroprene	Conex
Resistible temperature	80°C	130°C	200°C

(Notes) • Remember that the resistible temperatures shown in the table above are for the boots, not for the cylinder.

- Conex is the registered trademark of Teijin Ltd.
- If decimals are included into the calculation results, raise them to the next whole number.
- The boots have been mounted at our factory prior to delivery.



# 7/14 MPa double acting hydraulic cylinder

## Double acting single rod/double rod

Unit: mm

# 70/140H-8

72

### Dimensional table

Symbol Bore	Rod B							Rod C						
	A	B	KK	MM	S	SL	VD	A	B	KK	MM	S	SL	VD
φ32	25	φ34	M16×1.5	φ18	14	10	10	–	–	–	–	–	–	–
φ40	30	φ40	M20×1.5	φ22.4	19	11	10	25	φ36	M16×1.5	φ18	14	10	10
φ50	35	φ46	M24×1.5	φ28	24	14	10	30	φ40	M20×1.5	φ22.4	19	11	10
φ63	45	φ55	M30×1.5	φ35.5	30	16	10	35	φ46	M24×1.5	φ28	24	14	10
φ80	60	φ65	M39×1.5	φ45	41	20	10	45	φ55	M30×1.5	φ35.5	30	16	9
φ100	75	φ80	M48×1.5	φ56	50	23	10	60	φ65	M39×1.5	φ45	41	20	10
φ125	95	φ95	M64×2	φ71	65	27	10	75	φ80	M48×1.5	φ56	50	23	10
φ140	110	φ105	M72×2	φ80	75	31	10	80	φ85	M56×2	φ63	55	24	10
φ150	115	φ110	M76×2	φ85	80	33	10	85	φ90	M60×2	φ67	60	30	10
φ160	120	φ115	M80×2	φ90	85	33	10	95	φ95	M64×2	φ71	65	27	10
φ180	140	φ125	M95×2	φ100	–	Drill hole	10	110	φ105	M72×2	φ80	75	31	10
φ200	150	φ140	M100×2	φ112	–	Drill hole	10	120	φ115	M80×2	φ90	85	33	10
φ224	180	φ150	M120×2	φ125	–	Drill hole	10	140	φ125	M95×2	φ100	–	Drill hole	10
φ250	195	φ170	M130×2	φ140	–	Drill hole	10	150	φ140	M100×2	φ112	–	Drill hole	10

Symbol Bore	E	EE	F	FB	FP	HL	LZ	PJ	R	TF	UF	W	YP	ZH
φ32	□58	Rc 3/8	11	φ11	38	141	166	90	40	88	109	30	27	182
φ40	□65	Rc 3/8	11	φ11	38	141	166	90	46	95	118	30	27	182
φ50	□76	Rc 1/2	13	φ14	42	155	182	98	58	115	145	30	29	198
φ63	□90	Rc 1/2	15	φ18	46	163	194	102	65	132	165	35	31	213
φ80	□110	Rc 3/4	18	φ18	56	184	222	110	87	155	190	35	38	237
φ100	□135	Rc 3/4	20	φ22	58	192	232	116	109	190	230	40	38	252
φ125	□165	Rc 1	24	φ26	67	220	264	130	130	224	272	45	43	289
φ140	□185	Rc 1	26	φ26	69	230	276	138	145	250	300	50	43	306
φ150	□196	Rc 1	28	φ30	71	240	288	146	155	270	320	50	43	318
φ160	□210	Rc 1	31	φ33	74	253	304	156	170	285	345	55	43	339
φ180	□235	Rc 1 1/4	33	φ33	75	275	322	172	185	315	375	55	42	363
φ200	□262	Rc 1 1/2	37	φ36	85	301	354	184	206	355	425	55	48	393
φ224	□292	Rc 1 1/2	41	φ42	89	305	362	184	230	395	475	60	48	406
φ250	□325	Rc 2	46	φ45	106	346	412	200	250	425	515	65	60	457

• Allowance of B is h8, allowance of MM is f8.

### With boots

Bore		φ32	φ40	φ50	φ63	φ80	φ100	φ125	φ140	φ150	φ160	φ180	φ200	φ224	φ250
WW	Rod B	40	50	63	71	80	100	125	125	140	140	160	180	180	200
	Rod C	–	50	50	63	71	80	100	125	125	125	125	140	160	180
X	Rod B	45	45	45	55	55	55	65	65	65	65	65	65	80	80
	Rod C	–	45	45	55	55	55	65	65	65	65	65	65	80	80

General purpose hydraulic cylinder

CAD/DATA is available.

70-140H-8/TH8 Bore A.C



### CA

70H-8	1	CA	Bore	B	B	Stroke	-	A	B
140H-8	1	CA	Bore	B	B	Stroke	-	A	B

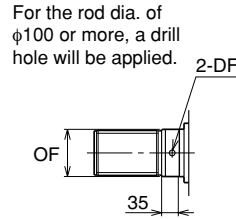

Rod dia.	OF	DF
φ100	φ99.5	φ12
φ112	φ111.5	φ15
φ125	φ124.5	φ15
φ140	φ139.5	φ15

General purpose hydraulic cylinder

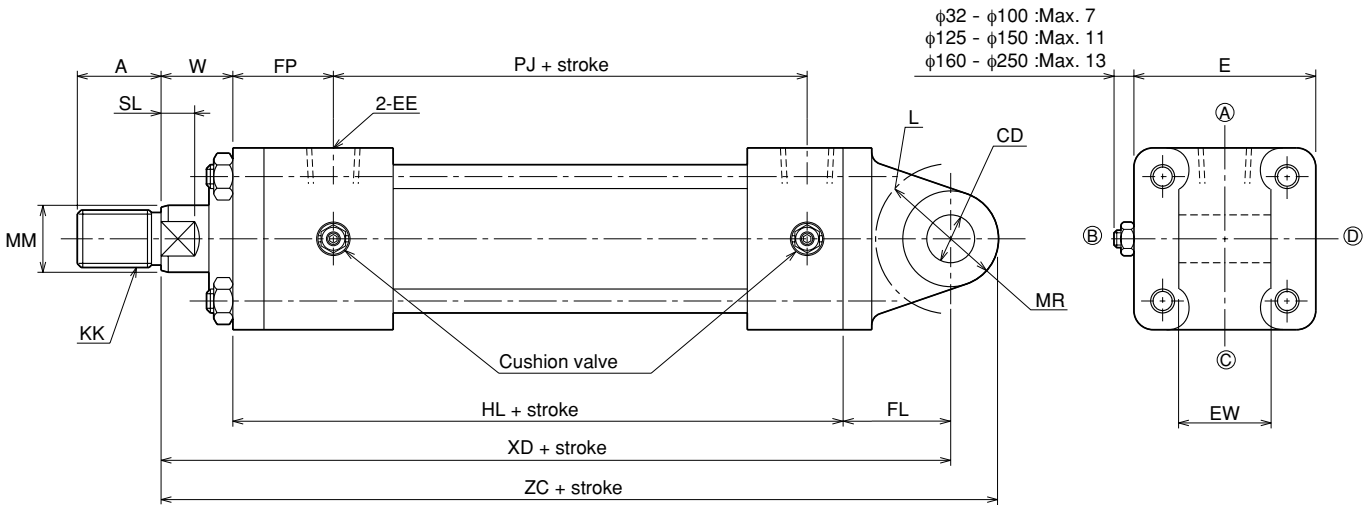

- For the dimensions other than in the diagram above, refer to the specification of the SD type (standard type).
- For the mounting of switches, refer to the dimensional drawings of "Switch set". All the contents other than "Switch mounting dimensions" are identical.
- For the type with a bore of φ180 or more, the CA accessory is equipped with the gray cast iron bush.
- The CA accessory, which is attached to the type with a bore of φ180 or more, is made of structural rolled steel (welding type), and is equipped with the gray cast iron bush.
- If the port's sizes are greater than 1 inch, we recommend you to order G thread or pipe flange. Please feel free to contact us. (Order made)

### With boots

70-140H-8/TH8 Bore K

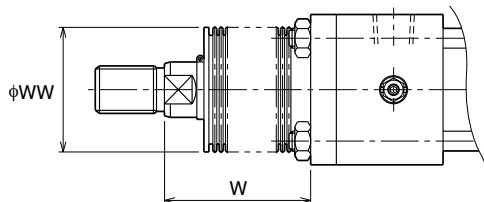

Rod B • C Nylon tarpaulin Chloroprene	$\left( \begin{array}{l} \phi 32 \\ \phi 40 \cdot \phi 50 \\ \phi 63 - \phi 100 \\ \phi 125 - \phi 200 \\ \phi 224 - \phi 250 \end{array} \right)$	$\left( \begin{array}{l} 1/3 \\ 1/3.5 \\ 1/4 \\ 1/5 \\ 1/6 \end{array} \right)$	$\left( \begin{array}{l} \text{Stroke} + X \\ \text{Stroke} + X \\ \text{Stroke} + X \\ \text{Stroke} + X \\ \text{Stroke} + X \end{array} \right)$
Conex	$\left( \begin{array}{l} \phi 32 \\ \phi 40 \cdot \phi 50 \\ \phi 63 - \phi 100 \\ \phi 125 \cdot \phi 140 \\ \phi 150 - \phi 200 \\ \phi 224 \cdot \phi 250 \end{array} \right)$	$\left( \begin{array}{l} 1/2 \\ 1/2.5 \\ 1/3 \\ 1/3.5 \\ 1/4 \\ 1/4.5 \end{array} \right)$	$\left( \begin{array}{l} \text{Stroke} + X \\ \text{Stroke} + X \\ \text{Stroke} + X \\ \text{Stroke} + X \\ \text{Stroke} + X \\ \text{Stroke} + X \end{array} \right)$

	Standard	Semi-standard	
<b>Material</b>	Nylon tarpaulin	Chloroprene	Conex
<b>Resistible temperature</b>	80°C	130°C	200°C

Notes) • Remember that the resistible temperatures shown in the table above are for the boots, not for the cylinder.  
 • Conex is the registered trademark of Teijin Ltd.  
 • If decimals are included into the calculation results, raise them to the next whole number.  
 • The boots have been mounted at our factory prior to delivery.

Rod A Nylon tarpaulin Chloroprene	$\left( \begin{array}{l} \phi 40 \\ \phi 50 - \phi 80 \\ \phi 100 - \phi 125 \end{array} \right)$	$\left( \begin{array}{l} 1/3.5 \\ 1/4 \\ 1/5 \end{array} \right)$	$\left( \begin{array}{l} \text{Stroke} + X \\ \text{Stroke} + X \\ \text{Stroke} + X \end{array} \right)$
Conex	$\left( \begin{array}{l} \phi 40 \\ \phi 50 - \phi 80 \\ \phi 100 \\ \phi 125 - \phi 160 \end{array} \right)$	$\left( \begin{array}{l} 1/2.5 \\ 1/3 \\ 1/3.5 \\ 1/4 \end{array} \right)$	$\left( \begin{array}{l} \text{Stroke} + X \\ \text{Stroke} + X \\ \text{Stroke} + X \\ \text{Stroke} + X \end{array} \right)$

# 7/14 MPa double acting hydraulic cylinder

## Double acting single rod/double rod

Unit: mm

# 70/140H-8

74

### Dimensional table

Symbol Bore	Rod B							Rod C							Rod A						
	A	B	KK	MM	S	SL	VD	A	B	KK	MM	S	SL	VD	A	B	KK	MM	S	SL	VD
φ32	25	φ34	M16×1.5	φ18	14	10	10	—	—	—	—	—	—	—	—	—	—	—	—	—	—
φ40	30	φ40	M20×1.5	φ22.4	19	11	10	25	φ36	M16×1.5	φ18	14	10	10	35	φ43	M24×1.5	φ28	24	14	17
φ50	35	φ46	M24×1.5	φ28	24	14	10	30	φ40	M20×1.5	φ22.4	19	11	10	45	φ50	M30×1.5	φ35.5	30	16	17
φ63	45	φ55	M30×1.5	φ35.5	30	16	10	35	φ46	M24×1.5	φ28	24	14	10	60	φ65	M39×1.5	φ45	41	20	19
φ80	60	φ65	M39×1.5	φ45	41	20	10	45	φ55	M30×1.5	φ35.5	30	16	9	75	φ80	M48×1.5	φ56	50	23	20
φ100	75	φ80	M48×1.5	φ56	50	23	10	60	φ65	M39×1.5	φ45	41	20	10	95	φ95	M64×2	φ71	65	27	23
φ125	95	φ95	M64×2	φ71	65	27	10	75	φ80	M48×1.5	φ56	50	23	10	120	φ115	M80×2	φ90	85	30	17
φ140	110	φ105	M72×2	φ80	75	31	10	80	φ85	M56×2	φ63	55	24	10	140	φ125	M95×2	φ100	—	Drill hole	17
φ150	115	φ110	M76×2	φ85	80	33	10	85	φ90	M60×2	φ67	60	30	10	140	φ125	M95×2	φ100	—	Drill hole	15
φ160	120	φ115	M80×2	φ90	85	33	10	95	φ95	M64×2	φ71	65	27	10	150	φ140	M100×2	φ112	—	Drill hole	16
φ180	140	φ125	M95×2	φ100	—	Drill hole	10	110	φ105	M72×2	φ80	75	31	10	—	—	—	—	—	—	—
φ200	150	φ140	M100×2	φ112	—	Drill hole	10	120	φ115	M80×2	φ90	85	33	10	—	—	—	—	—	—	—
φ224	180	φ150	M120×2	φ125	—	Drill hole	10	140	φ125	M95×2	φ100	—	Drill hole	10	—	—	—	—	—	—	—
φ250	195	φ170	M130×2	φ140	—	Drill hole	10	150	φ140	M100×2	φ112	—	Drill hole	10	—	—	—	—	—	—	—

Symbol Bore	CD	E	EE	EW	FL	FP	HL	L	MR	PJ	W		XD		ZC	
											B·C	A	B·C	A	B·C	A
φ32	φ16H9	□58	Rc 3/8	25 <sup>-0.1</sup> <sub>-0.4</sub>	38	38	141	R20	R16	90	30	—	209	—	225	—
φ40	φ16H9	□65	Rc 3/8	25 <sup>-0.1</sup> <sub>-0.4</sub>	38	38	141	R20	R16	90	30	35	209	214	225	230
φ50	φ20H9	□76	Rc 1/2	31.5 <sup>-0.1</sup> <sub>-0.4</sub>	45	42	155	R25	R20	98	30	41	230	241	250	261
φ63	φ31.5H9	□90	Rc 1/2	40 <sup>-0.1</sup> <sub>-0.4</sub>	63	46	163	R46	R31.5	102	35	48	261	274	292.5	305.5
φ80	φ31.5H9	□110	Rc 3/4	40 <sup>-0.1</sup> <sub>-0.4</sub>	72	56	184	R52	R31.5	110	35	51	291	307	322.5	338.5
φ100	φ40H9	□135	Rc 3/4	50 <sup>-0.1</sup> <sub>-0.4</sub>	84	58	192	R62	R40	116	40	57	316	333	356	373
φ125	φ50H9	□165	Rc 1	63 <sup>-0.1</sup> <sub>-0.4</sub>	100	67	220	R73	R50	130	45	57	365	377	415	427
φ140	φ63H9	□185	Rc 1	80 <sup>-0.1</sup> <sub>-0.6</sub>	120	69	230	R91	R63	138	50	57	400	407	463	470
φ150	φ63H9	□196	Rc 1	80 <sup>-0.1</sup> <sub>-0.6</sub>	122	71	240	R91	R63	146	50	57	412	419	475	482
φ160	φ71H9	□210	Rc 1	80 <sup>-0.1</sup> <sub>-0.6</sub>	137	74	253	R103	R71	156	55	57	445	447	516	518
φ180	φ80H9	□235	Rc 1 1/4	100 <sup>-0.1</sup> <sub>-0.6</sub>	150	75	275	R100	R80	172	55	—	480	—	560	—
φ200	φ90H9	□262	Rc 1 1/2	125 <sup>-0.1</sup> <sub>-0.6</sub>	170	85	301	R115	R90	184	55	—	526	—	616	—
φ224	φ100H9	□292	Rc 1 1/2	125 <sup>-0.1</sup> <sub>-0.6</sub>	185	89	305	R125	R100	184	60	—	550	—	650	—
φ250	φ100H9	□325	Rc 2	125 <sup>-0.1</sup> <sub>-0.6</sub>	185	106	346	R125	R100	200	65	—	596	—	696	—

• Allowance of B is h8, allowance of MM is f8.

### With boots

Symbol	Bore	φ32	φ40	φ50	φ63	φ80	φ100	φ125	φ140	φ150	φ160	φ180	φ200	φ224	φ250
		WW	Rod B	40	50	63	71	80	100	125	125	140	140	160	180
Rod C	—		50	50	63	71	80	100	125	125	125	125	140	160	180
Rod A	—		63	71	80	100	125	140	160	160	180	—	—	—	—
X	Rod B	45	45	45	55	55	55	65	65	65	65	65	65	80	80
	Rod C	—	45	45	55	55	55	65	65	65	65	65	65	80	80
	Rod A	—	45	55	55	55	65	65	65	65	65	—	—	—	—

General purpose hydraulic cylinder

### CS

70H-8	1	CS	Bore	B	B	Stroke	-	A	B
140H-8	1	CS	Bore	B	B	Stroke	-	A	B

General purpose hydraulic cylinder

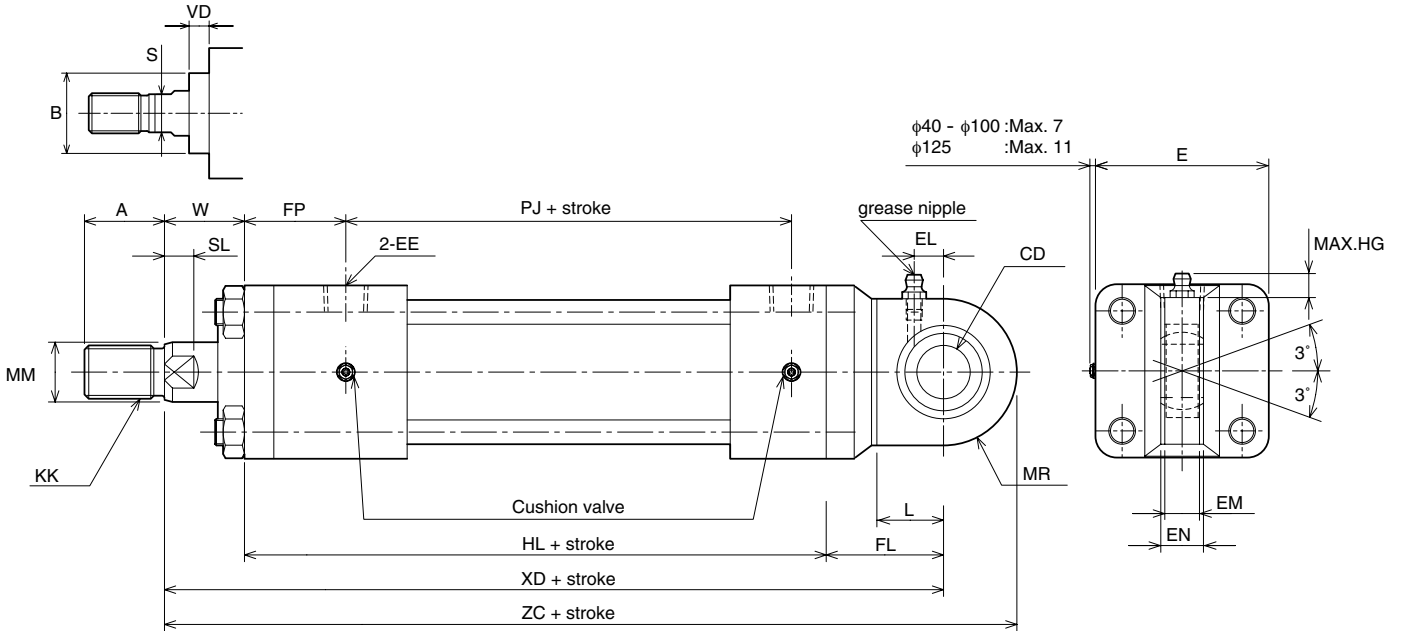

- The grease is not sealed at the shipment.
- Inner diameter and installation width of bearing are conformed to JIS B8367-2 MP5 type regulation. (Same standard with 160H-1 series.)
- For the dimensions other than in the diagram above, refer to the specification of the SD type (standard type).
- For the mounting of switches, refer to the dimensional drawings of "Switch set". All the contents other than "Switch mounting dimensions" are identical.

### With boots

70-140H-8/TH8 [Bore]K

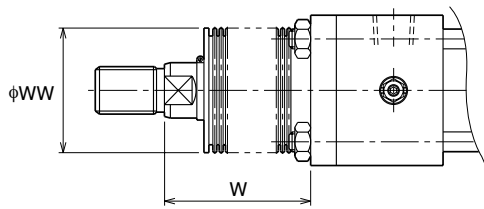

Rod B · C	( φ40 · φ50 φ63 - φ100 φ125	( 1/3.5 1/4 1/5	( Stroke + X Stroke + X Stroke + X
Nylon tarpaulin			
Chloroprene			
Conex	( φ40 · φ50 φ63 - φ100 φ125	( 1/2.5 1/3 1/3.5	( Stroke + X Stroke + X Stroke + X

	Standard	Semi-standard	
<b>Material</b>	Nylon tarpaulin	Chloroprene	Conex
<b>Resistible temperature</b>	80°C	130°C	200°C

- Notes) • Remember that the resistible temperatures shown in the table above are for the boots, not for the cylinder.  
 • Conex is the registered trademark of Teijin Ltd.  
 • If decimals are included into the calculation results, raise them to the next whole number.  
 • The boots have been mounted at our factory prior to delivery.

Rod A	( φ40 φ50 - φ80 φ100 · φ125	( 1/3.5 1/4 1/5	( Stroke + X Stroke + X Stroke + X
Nylon tarpaulin			
Chloroprene			
Conex	( φ40 φ50 - φ80 φ100 φ125	( 1/2.5 1/3 1/3.5 1/4	( Stroke + X Stroke + X Stroke + X Stroke + X

Dimensional table

Symbol Bore	Rod B							Rod C							Rod A						
	A	B	KK	MM	S	SL	VD	A	B	KK	MM	S	SL	VD	A	B	KK	MM	S	SL	VD
φ40	30	φ40	M20×1.5	φ22.4	19	11	10	25	φ36	M16×1.5	φ18	14	10	10	35	φ43	M24×1.5	φ28	24	14	17
φ50	35	φ46	M24×1.5	φ28	24	14	10	30	φ40	M20×1.5	φ22.4	19	11	10	45	φ50	M30×1.5	φ35.5	30	16	17
φ63	45	φ55	M30×1.5	φ35.5	30	16	10	35	φ46	M24×1.5	φ28	24	14	10	60	φ65	M39×1.5	φ45	41	20	19
φ80	60	φ65	M39×1.5	φ45	41	20	10	45	φ55	M30×1.5	φ35.5	30	16	9	75	φ80	M48×1.5	φ56	50	23	20
φ100	75	φ80	M48×1.5	φ56	50	23	10	60	φ65	M39×1.5	φ45	41	20	10	95	φ95	M64×2	φ71	65	27	23
φ125	95	φ95	M64×2	φ71	65	27	10	75	φ80	M48×1.5	φ56	50	23	10	120	φ115	M80×2	φ90	85	33	17

Symbol Bore	CD	E	EE	EN	EM	FL	FP	HL	L	MR	PJ	W		XD		ZC		grease nipple		
												B•C	A	B•C	A	B•C	A	Code	EL	HG
φ40	φ20 <sup>0</sup> <sub>-0.012</sub>	□65	Rc3/8	16 <sup>0</sup> <sub>-0.12</sub>	13	44	38	141	25	R27.5	90	30	35	215	220	242.5	247.5	JIS A type MT6×1	11	11
φ50	φ25 <sup>0</sup> <sub>-0.012</sub>	□76	Rc1/2	20 <sup>0</sup> <sub>-0.12</sub>	17	53	42	155	31	R32.5	98	30	41	238	249	270.5	281.5	JIS A type MT6×1	14	11
φ63	φ30 <sup>0</sup> <sub>-0.012</sub>	□90	Rc1/2	22 <sup>0</sup> <sub>-0.12</sub>	19	64	46	163	38	R40	102	35	48	262	275	302	315	JIS A type Rc1/8	15	15
φ80	φ40 <sup>0</sup> <sub>-0.012</sub>	□110	Rc3/4	28 <sup>0</sup> <sub>-0.12</sub>	23	81	56	184	48	R50	110	35	51	300	316	350	366	JIS A type Rc1/8	20	15
φ100	φ50 <sup>0</sup> <sub>-0.012</sub>	□135	Rc3/4	35 <sup>0</sup> <sub>-0.12</sub>	30	96	58	192	58	R60	116	40	57	328	345	388	405	JIS A type Rc1/8	24	15
φ125	φ60 <sup>0</sup> <sub>-0.015</sub>	□165	Rc1	44 <sup>0</sup> <sub>-0.15</sub>	38	117	67	220	72	R75	130	45	57	382	394	457	469	JIS A type Rc1/8	28	15

● Allowance of B is h8, allowance of MM is f8.

With boots

		Bore					
Symbol		φ40	φ50	φ63	φ80	φ100	φ125
WW	Rod B	50	63	71	80	100	125
	Rod C	50	50	63	71	80	100
	Rod A	63	71	80	100	125	140
X	Rod B	45	45	55	55	55	65
	Rod C	45	45	55	55	55	65
	Rod A	45	55	55	55	65	65

CAD/DATA is available.

70-140H-8/TH8 Bore A.C

## CB

70H-8	1	CB	Bore	B	B	Stroke	-	A	B
140H-8	1	CB	Bore	B	B	Stroke	-	A	B

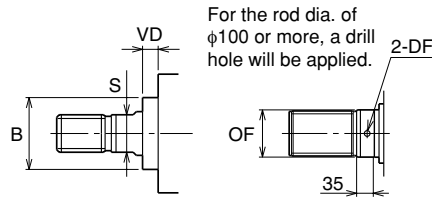

Rod dia.	OF	DF
φ100	φ99.5	φ12
φ112	φ111.5	φ15
φ125	φ124.5	φ15
φ140	φ139.5	φ15

## • Bore φ32 - φ80

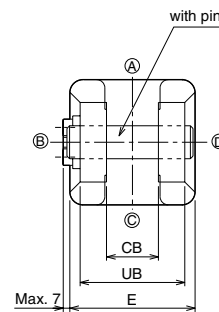
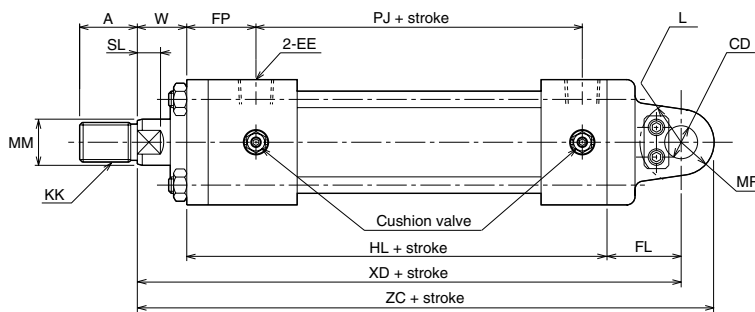

## • Bore φ100 - φ250

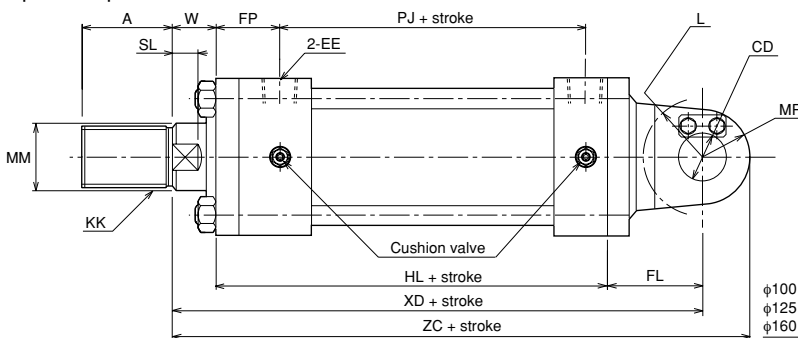

φ100 :Max. 7  
φ125 - φ150 :Max. 11  
φ160 - φ250 :Max. 13

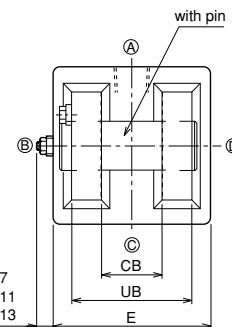

- For the dimensions other than in the diagram above, refer to the specification of the SD type (standard type).
- For the mounting of switches, refer to the dimensional drawings of "Switch set". All the contents other than "Switch mounting dimensions" are identical.
- Material of CB accessory for type with a bore of φ32 to φ160: nodular graphite cast iron.
- Material of CB accessory for type with a bore of φ180 or more: structural rolled steel.
- If the port's sizes are greater than 1 inch, we recommend you to order G thread or pipe flange. Please feel free to contact us. (Order made)

## With boots

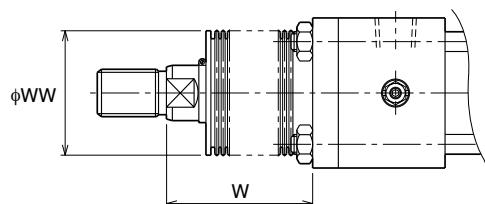
70-140H-8/TH8 Bore K

Material	Boots	Stroke	Stroke + X
Rod B • C Nylon tarpaulin Chloroprene	φ32	1/3	Stroke + X
	φ40 • φ50	1/3.5	Stroke + X
	φ63 - φ100	1/4	Stroke + X
	φ125 - φ200	1/5	Stroke + X
	φ224 • φ250	1/6	Stroke + X
Conex	φ32	1/2	Stroke + X
	φ40 • φ50	1/2.5	Stroke + X
	φ63 - φ100	1/3	Stroke + X
	φ125 • φ140	1/3.5	Stroke + X
	φ150 - φ200	1/4	Stroke + X
	φ224 • φ250	1/4.5	Stroke + X

	Standard	Semi-standard	
Material	Nylon tarpaulin	Chloroprene	Conex
Resistible temperature	80°C	130°C	200°C

Notes) • Remember that the resistible temperatures shown in the table above are for the boots, not for the cylinder.  
• Conex is the registered trademark of Teijin Ltd.  
• If decimals are included into the calculation results, raise them to the next whole number.  
• The boots have been mounted at our factory prior to delivery.

Material	Boots	Stroke	Stroke + X
Rod A Nylon tarpaulin Chloroprene	φ40	1/3.5	Stroke + X
	φ50 - φ80	1/4	Stroke + X
	φ100 - φ160	1/5	Stroke + X
Conex	φ40	1/2.5	Stroke + X
	φ50 - φ80	1/3	Stroke + X
	φ100	1/3.5	Stroke + X
	φ125 - φ160	1/4	Stroke + X

# 7/14 MPa double acting hydraulic cylinder

## Double acting single rod/double rod

Unit: mm

# 70/140H-8

78

### Dimensional table

Symbol Bore	Rod B							Rod C							Rod A						
	A	B	KK	MM	S	SL	VD	A	B	KK	MM	S	SL	VD	A	B	KK	MM	S	SL	VD
φ32	25	φ34	M16×1.5	φ18	14	10	10	—	—	—	—	—	—	—	—	—	—	—	—	—	—
φ40	30	φ40	M20×1.5	φ22.4	19	11	10	25	φ36	M16×1.5	φ18	14	10	10	35	φ43	M24×1.5	φ28	24	14	17
φ50	35	φ46	M24×1.5	φ28	24	14	10	30	φ40	M20×1.5	φ22.4	19	11	10	45	φ50	M30×1.5	φ35.5	30	16	17
φ63	45	φ55	M30×1.5	φ35.5	30	16	10	35	φ46	M24×1.5	φ28	24	14	10	60	φ65	M39×1.5	φ45	41	20	19
φ80	60	φ65	M39×1.5	φ45	41	20	10	45	φ55	M30×1.5	φ35.5	30	16	9	75	φ80	M48×1.5	φ56	50	23	20
φ100	75	φ80	M48×1.5	φ56	50	23	10	60	φ65	M39×1.5	φ45	41	20	10	95	φ95	M64×2	φ71	65	27	23
φ125	95	φ95	M64×2	φ71	65	27	10	75	φ80	M48×1.5	φ56	50	23	10	120	φ115	M80×2	φ90	85	33	17
φ140	110	φ105	M72×2	φ80	75	31	10	80	φ85	M56×2	φ63	55	24	10	140	φ125	M95×2	φ100	—	Drill hole	17
φ150	115	φ110	M76×2	φ85	80	33	10	85	φ90	M60×2	φ67	60	30	10	140	φ125	M95×2	φ100	—	Drill hole	15
φ160	120	φ115	M80×2	φ90	85	33	10	95	φ95	M64×2	φ71	65	27	10	150	φ140	M100×2	φ112	—	Drill hole	16
φ180	140	φ125	M95×2	φ100	—	Drill hole	10	110	φ105	M72×2	φ80	75	31	10	—	—	—	—	—	—	—
φ200	150	φ140	M100×2	φ112	—	Drill hole	10	120	φ115	M80×2	φ90	85	33	10	—	—	—	—	—	—	—
φ224	180	φ150	M120×2	φ125	—	Drill hole	10	140	φ125	M95×2	φ100	—	Drill hole	10	—	—	—	—	—	—	—
φ250	195	φ170	M130×2	φ140	—	Drill hole	10	150	φ140	M100×2	φ112	—	Drill hole	10	—	—	—	—	—	—	—

Symbol Bore	CB	CD	E	EE	FL	FP	HL	L	MR	PJ	UB	W		XD		ZC	
												B•C	A	B•C	A	B•C	A
φ32	25 <sup>+0.4</sup> / <sub>+0.1</sub>	φ16 <sup>H9</sup> / <sub>f8</sub>	□58	Rc 3/8	38	38	141	R20	R16	90	50	30	—	209	—	225	—
φ40	25 <sup>+0.4</sup> / <sub>+0.1</sub>	φ16 <sup>H9</sup> / <sub>f8</sub>	□65	Rc 3/8	38	38	141	R20	R16	90	50	30	35	209	214	225	230
φ50	31.5 <sup>+0.4</sup> / <sub>+0.1</sub>	φ20 <sup>H9</sup> / <sub>f8</sub>	□76	Rc 1/2	45	42	155	R25	R20	98	63.5	30	41	230	241	250	261
φ63	40 <sup>+0.4</sup> / <sub>+0.1</sub>	φ31.5 <sup>H9</sup> / <sub>f8</sub>	□90	Rc 1/2	63	46	163	R40	R31.5	102	80	35	48	261	274	292.5	305.5
φ80	40 <sup>+0.4</sup> / <sub>+0.1</sub>	φ31.5 <sup>H9</sup> / <sub>f8</sub>	□110	Rc 3/4	72	56	184	R40	R31.5	110	80	35	51	291	307	322.5	338.5
φ100	50 <sup>+0.4</sup> / <sub>+0.1</sub>	φ40 <sup>H9</sup> / <sub>f8</sub>	□135	Rc 3/4	84	58	192	R50	R40	116	100	40	57	316	333	356	373
φ125	63 <sup>+0.4</sup> / <sub>+0.1</sub>	φ50 <sup>H9</sup> / <sub>f8</sub>	□165	Rc 1	100	67	220	R62	R50	130	126	45	57	365	377	415	427
φ140	80 <sup>+0.6</sup> / <sub>+0.1</sub>	φ63 <sup>H9</sup> / <sub>f8</sub>	□185	Rc 1	120	69	230	R79	R63	138	160	50	57	400	407	463	470
φ150	80 <sup>+0.6</sup> / <sub>+0.1</sub>	φ63 <sup>H9</sup> / <sub>f8</sub>	□196	Rc 1	122	71	240	R82	R63	146	160	50	57	412	419	475	482
φ160	80 <sup>+0.6</sup> / <sub>+0.1</sub>	φ71 <sup>H9</sup> / <sub>f8</sub>	□210	Rc 1	137	74	253	R89	R71	156	160	55	57	445	447	516	518
φ180	100 <sup>+0.6</sup> / <sub>+0.1</sub>	φ80 <sup>H9</sup> / <sub>f8</sub>	□235	Rc 1 1/4	150	75	275	R100	R80	172	200	55	—	480	—	560	—
φ200	125 <sup>+0.6</sup> / <sub>+0.1</sub>	φ90 <sup>H9</sup> / <sub>f8</sub>	□262	Rc 1 1/2	170	85	301	R115	R90	184	251	55	—	526	—	616	—
φ224	125 <sup>+0.6</sup> / <sub>+0.1</sub>	φ100 <sup>H9</sup> / <sub>f8</sub>	□292	Rc 1 1/2	185	89	305	R125	R100	184	251	60	—	550	—	650	—
φ250	125 <sup>+0.6</sup> / <sub>+0.1</sub>	φ100 <sup>H9</sup> / <sub>f8</sub>	□325	Rc 2	185	106	346	R125	R100	200	251	65	—	596	—	696	—

• Allowance of B is h8, allowance of MM is f8.

### With boots

Symbol	Bore	φ32	φ40	φ50	φ63	φ80	φ100	φ125	φ140	φ150	φ160	φ180	φ200	φ224	φ250
		WW	Rod B	40	50	63	71	80	100	125	125	140	140	160	180
Rod C	—		50	50	63	71	80	100	125	125	125	125	140	160	180
Rod A	—		63	71	80	100	125	140	160	160	180	—	—	—	—
X	Rod B	45	45	45	55	55	55	65	65	65	65	65	65	80	80
	Rod C	—	45	45	55	55	55	65	65	65	65	65	65	80	80
	Rod A	—	45	55	55	55	65	65	65	65	65	—	—	—	—

General purpose hydraulic cylinder

CAD/DATA is available.

70-140H-8/TH8 Bore A.C



### TA

70H-8	1	TA	<span style="border: 1px solid black; padding: 2px;">Bore</span>	<span style="border: 1px solid black; padding: 2px;">B</span>	<span style="border: 1px solid black; padding: 2px;">B</span>	<span style="border: 1px solid black; padding: 2px;">Stroke</span>	- A C
140H-8	1	TA	<span style="border: 1px solid black; padding: 2px;">Bore</span>	<span style="border: 1px solid black; padding: 2px;">B</span>	<span style="border: 1px solid black; padding: 2px;">B</span>	<span style="border: 1px solid black; padding: 2px;">Stroke</span>	- A C

For the rod dia. of  $\phi 100$  or more, a drill hole will be applied.

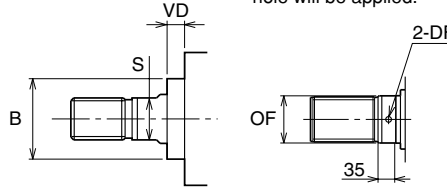

Rod dia.	OF	DF
$\phi 100$	$\phi 99.5$	$\phi 12$
$\phi 112$	$\phi 111.5$	$\phi 15$
$\phi 125$	$\phi 124.5$	$\phi 15$
$\phi 140$	$\phi 139.5$	$\phi 15$

General purpose hydraulic cylinder

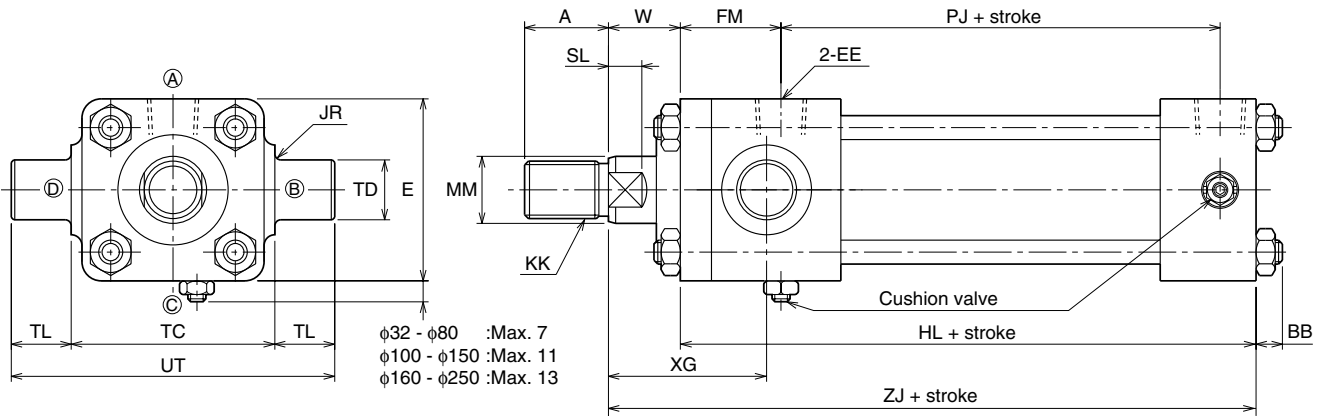

- For the dimensions other than in the diagram above, refer to the specification of the SD type (standard type).
- For the mounting of switches, refer to the dimensional drawings of "Switch set". All the contents other than "Switch mounting dimensions" are identical.
- The cushion valve and air vent positions of the TA type are ©, on account of the structural conditions (rod cover side).
- If the port's sizes are greater than 1 inch, we recommend you to order G thread or pipe flange. Please feel free to contact us. (Order made)

### Double rod type (rod B, C) For both ends loaded type

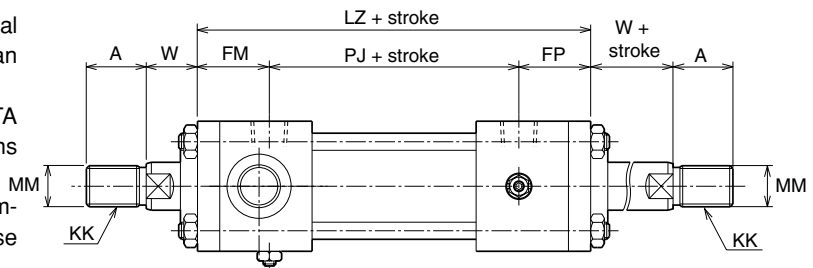

- The switch set ( $\phi 32 - \phi 140$ ) is also within the fabrication range.

### With boots

70-140H-8/TH8 BoreK

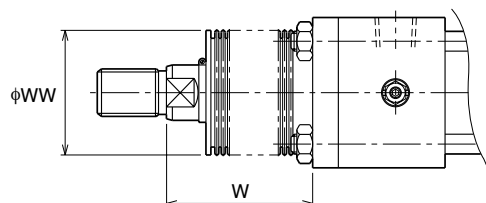

Material	Rod Dia.	Stroke	Stroke + X
Rod B • C Nylon tarpaulin Chloroprene	$\phi 32$	1/3	Stroke + X
	$\phi 40$ • $\phi 50$	1/3.5	Stroke + X
	$\phi 63 - \phi 100$	1/4	Stroke + X
	$\phi 125 - \phi 200$	1/5	Stroke + X
	$\phi 224 - \phi 250$	1/6	Stroke + X
Conex	$\phi 32$	1/2	Stroke + X
	$\phi 40$ • $\phi 50$	1/2.5	Stroke + X
	$\phi 63 - \phi 100$	1/3	Stroke + X
	$\phi 125$ • $\phi 140$	1/3.5	Stroke + X
	$\phi 150 - \phi 200$	1/4	Stroke + X
	$\phi 224$ • $\phi 250$	1/4.5	Stroke + X

	Standard	Semi-standard	
<b>Material</b>	Nylon tarpaulin	Chloroprene	Conex
<b>Resistible temperature</b>	80°C	130°C	200°C

- Notes) • Remember that the resistible temperatures shown in the table above are for the boots, not for the cylinder.  
 • Conex is the registered trademark of Teijin Ltd.  
 • If decimals are included into the calculation results, raise them to the next whole number.  
 • The boots have been mounted at our factory prior to delivery.

Material	Rod Dia.	Stroke	Stroke + X
Rod A Nylon tarpaulin Chloroprene	$\phi 40$	1/3.5	Stroke + X
	$\phi 50 - \phi 80$	1/4	Stroke + X
	$\phi 100 - \phi 160$	1/5	Stroke + X
Conex	$\phi 40$	1/2.5	Stroke + X
	$\phi 50 - \phi 80$	1/3	Stroke + X
	$\phi 100$	1/3.5	Stroke + X
	$\phi 125 - \phi 160$	1/4	Stroke + X



# 7/14 MPa double acting hydraulic cylinder

## Double acting single rod/double rod

Unit: mm

# 70/140H-8

80

### Dimensional table

Symbol	Rod B							Rod C							Rod A							
	A	B	KK	MM	S	SL	VD	A	B	KK	MM	S	SL	VD	A	B	KK	MM	S	SL	VD	
φ32	25	φ34	M16×1.5	φ18	14	10	10	—	—	—	—	—	—	—	—	—	—	—	—	—	—	—
φ40	30	φ40	M20×1.5	φ22.4	19	11	10	25	φ36	M16×1.5	φ18	14	10	10	35	φ43	M24×1.5	φ28	24	14	17	17
φ50	35	φ46	M24×1.5	φ28	24	14	10	30	φ40	M20×1.5	φ22.4	19	11	10	45	φ50	M30×1.5	φ35.5	30	16	17	17
φ63	45	φ55	M30×1.5	φ35.5	30	16	10	35	φ46	M24×1.5	φ28	24	14	10	60	φ65	M39×1.5	φ45	41	20	19	19
φ80	60	φ65	M39×1.5	φ45	41	20	10	45	φ55	M30×1.5	φ35.5	30	16	9	75	φ80	M48×1.5	φ56	50	23	20	20
φ100	75	φ80	M48×1.5	φ56	50	23	10	60	φ65	M39×1.5	φ45	41	20	10	95	φ95	M64×2	φ71	65	27	23	23
φ125	95	φ95	M64×2	φ71	65	27	10	75	φ80	M48×1.5	φ56	50	23	10	120	φ115	M80×2	φ90	85	33	17	17
φ140	110	φ105	M72×2	φ80	75	31	10	80	φ85	M56×2	φ63	55	24	10	140	φ125	M95×2	φ100	—	Drill hole	17	
φ150	115	φ110	M76×2	φ85	80	33	10	85	φ90	M60×2	φ67	60	30	10	140	φ125	M95×2	φ100	—	Drill hole	15	
φ160	120	φ115	M80×2	φ90	85	33	10	95	φ95	M64×2	φ71	65	27	10	150	φ140	M100×2	φ112	—	Drill hole	16	
φ180	140	φ125	M95×2	φ100	—	Drill hole	10	110	φ105	M72×2	φ80	75	31	10	—	—	—	—	—	—	—	—
φ200	150	φ140	M100×2	φ112	—	Drill hole	10	120	φ115	M80×2	φ90	85	33	10	—	—	—	—	—	—	—	—
φ224	180	φ150	M120×2	φ125	—	Drill hole	10	140	φ125	M95×2	φ100	—	Drill hole	10	—	—	—	—	—	—	—	—
φ250	195	φ170	M130×2	φ140	—	Drill hole	10	150	φ140	M100×2	φ112	—	Drill hole	10	—	—	—	—	—	—	—	—

Symbol	Bore	BB	E	EE	FM	FP	HL	JR	LZ	PJ	TC	TD	TL	UT	W		XG		ZJ	
															B·C	A	B·C	A	B·C	A
φ32	11	□58	Rc3/8	38	38	141	R2	166	90	58 <sup>0</sup> <sub>-0.3</sub>	φ20e9	20	98	30	—	62	—	171	—	—
φ40	11	□65	Rc3/8	38	38	141	R2	166	90	69 <sup>0</sup> <sub>-0.3</sub>	φ20e9	20	109	30	35	62	67	171	176	—
φ50	11	□76	Rc1/2	42	42	155	R2.5	182	98	85 <sup>0</sup> <sub>-0.35</sub>	φ25e9	25	135	30	41	66	77	185	196	—
φ63	13	□90	Rc1/2	46	46	163	R2.5	194	102	98 <sup>0</sup> <sub>-0.35</sub>	φ31.5e9	31.5	161	35	48	74	87	198	211	—
φ80	16	□110	Rc3/4	56	56	184	R2.5	222	110	118 <sup>0</sup> <sub>-0.35</sub>	φ31.5e9	31.5	181	35	51	82	98	219	235	—
φ100	18	□135	Rc3/4	58	58	192	R3	232	116	145 <sup>0</sup> <sub>-0.4</sub>	φ40e9	40	225	40	57	89	106	232	249	—
φ125	21	□165	Rc1	67	67	220	R3	264	130	175 <sup>0</sup> <sub>-0.4</sub>	φ50e9	50	275	45	57	103	115	265	277	—
φ140	22	□185	Rc1	69	69	230	R4	276	138	195 <sup>0</sup> <sub>-0.46</sub>	φ63e9	63	321	50	57	112	119	280	287	—
φ150	25	□196	Rc1	71	71	240	R4	288	146	206 <sup>0</sup> <sub>-0.46</sub>	φ63e9	63	332	50	57	112	119	290	297	—
φ160	25	□210	Rc1	74	74	253	R4	304	156	218 <sup>0</sup> <sub>-0.46</sub>	φ71e9	71	360	55	57	126	128	308	310	—
φ180	27	□235	Rc1 1/4	106	75	275	R4	353	172	243 <sup>0</sup> <sub>-0.46</sub>	φ80e9	80	403	55	—	136	—	361	—	—
φ200	29	□262	Rc1 1/2	116	85	301	R5	385	184	272 <sup>0</sup> <sub>-0.52</sub>	φ90e9	90	452	55	—	145	—	387	—	—
φ224	34	□292	Rc1 1/2	129	89	305	R5	402	184	300 <sup>0</sup> <sub>-0.52</sub>	φ100e9	100	500	60	—	160	—	405	—	—
φ250	37	□325	Rc2	126	106	346	R5	432	200	335 <sup>0</sup> <sub>-0.57</sub>	φ100e9	100	535	65	—	170	—	431	—	—

● Allowance of B is h8, allowance of MM is f8.

### With boots

Symbol	Bore	φ32	φ40	φ50	φ63	φ80	φ100	φ125	φ140	φ150	φ160	φ180	φ200	φ224	φ250
WW	Rod B	40	50	63	71	80	100	125	125	140	140	160	180	180	200
	Rod C	—	50	50	63	71	80	100	125	125	125	125	140	160	180
	Rod A	—	63	71	80	100	125	140	160	160	180	—	—	—	—
X	Rod B	45	45	45	55	55	55	65	65	65	65	65	65	80	80
	Rod C	—	45	45	55	55	55	65	65	65	65	65	65	80	80
	Rod A	—	45	55	55	55	65	65	65	65	65	—	—	—	—

General purpose hydraulic cylinder

CAD/DATA is available.



70-140H-8/TH8 Bore A.C

### TC

70H-8	1	TC	Bore	B	B	Stroke	-	A	B
140H-8	1	TC	Bore	B	B	Stroke	-	A	B

For the rod dia. of  $\phi 100$  or more, a drill hole will be applied.

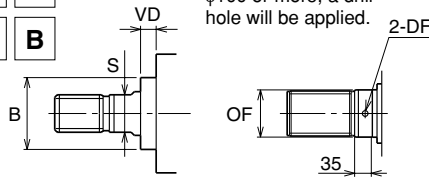

Rod dia.	OF	DF
$\phi 100$	$\phi 99.5$	$\phi 12$
$\phi 112$	$\phi 111.5$	$\phi 15$
$\phi 125$	$\phi 124.5$	$\phi 15$
$\phi 140$	$\phi 139.5$	$\phi 15$

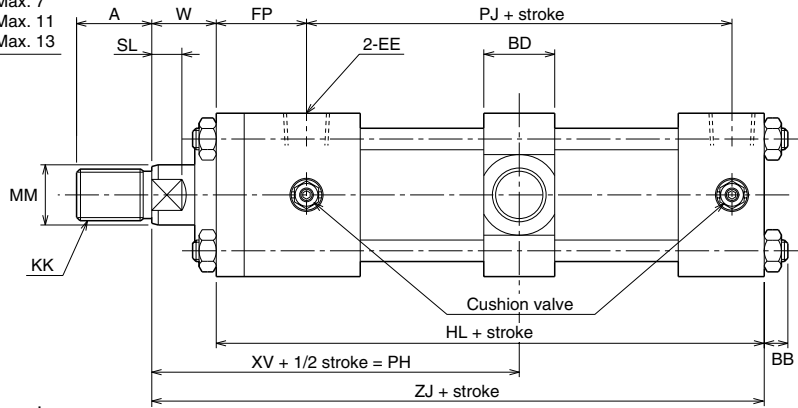
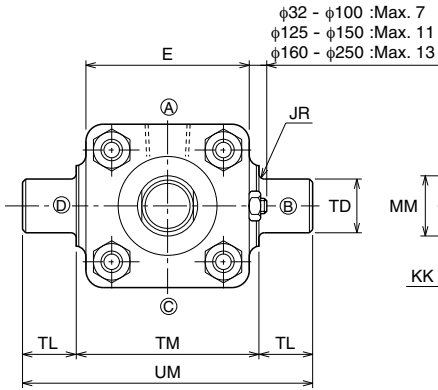

- For the dimensions other than in the diagram above, refer to the specification of the SD type (standard type).
- For the mounting of switches, refer to the dimensional drawings of "Switch set". All the contents other than "Switch mounting dimensions and minimum PN" are identical to this table.
- Please specify the PH dimension in case of TC mounting transfer.
- The minimum available stroke for each bore (140mm to 250mm) is on the table below.
- If the port's sizes are greater than 1 inch, we recommend you to order G thread or pipe flange. Please feel free to contact us. (Order made)

Minimum available strokes

Bore	Min. stroke	Bore	Min. stroke
$\phi 140$	6	$\phi 200$	18
$\phi 150$	0	$\phi 224$	27
$\phi 160$	8	$\phi 250$	27
$\phi 180$	12		

### Double rod type ( $\phi 32 - \phi 250$ /rod B, C) For both ends loaded type

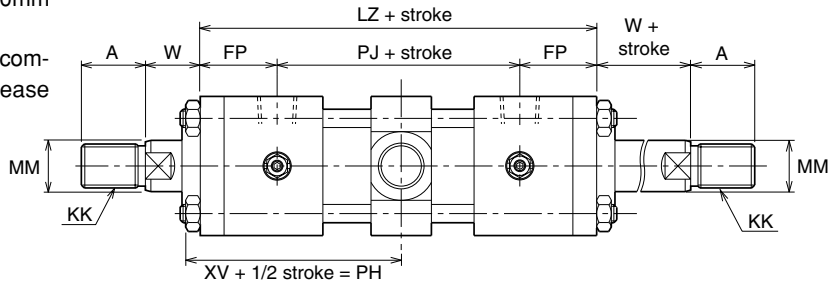

- The switch set ( $\phi 32 - \phi 140$ ) is also within the fabrication range.

### With boots

70-140H-8/TH8 Bore K

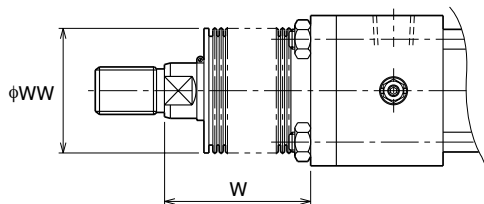

Material	Rod Dia.	Stroke	Stroke + X
Nylon tarpaulin Chloroprene	$\phi 32$	1/3	Stroke + X
	$\phi 40 - \phi 50$	1/3.5	Stroke + X
	$\phi 63 - \phi 100$	1/4	Stroke + X
	$\phi 125 - \phi 200$	1/5	Stroke + X
	$\phi 224 - \phi 250$	1/6	Stroke + X
Conex	$\phi 32$	1/2	Stroke + X
	$\phi 40 - \phi 50$	1/2.5	Stroke + X
	$\phi 63 - \phi 100$	1/3	Stroke + X
	$\phi 125 - \phi 140$	1/3.5	Stroke + X
	$\phi 150 - \phi 200$	1/4	Stroke + X
$\phi 224 - \phi 250$	1/4.5	Stroke + X	

	Standard	Semi-standard	
<b>Material</b>	Nylon tarpaulin	Chloroprene	Conex
<b>Resistible temperature</b>	80°C	130°C	200°C

Notes) • Remember that the resistible temperatures shown in the table above are for the boots, not for the cylinder.  
• Conex is the registered trademark of Teijin Ltd.  
• If decimals are included into the calculation results, raise them to the next whole number.  
• The boots have been mounted at our factory prior to delivery.

Material	Rod Dia.	Stroke	Stroke + X
Nylon tarpaulin Chloroprene	$\phi 40$	1/3.5	Stroke + X
	$\phi 50 - \phi 80$	1/4	Stroke + X
	$\phi 100 - \phi 160$	1/5	Stroke + X
Conex	$\phi 40$	1/2.5	Stroke + X
	$\phi 50 - \phi 80$	1/3	Stroke + X
	$\phi 100$	1/3.5	Stroke + X
	$\phi 125 - \phi 160$	1/4	Stroke + X

# 7/14 MPa double acting hydraulic cylinder

## Double acting single rod/double rod

Unit: mm

# 70/140H-8

### Dimensional table

Symbol Bore	Rod B							Rod C							Rod A								
	A	B	KK	MM	S	SL	VD	A	B	KK	MM	S	SL	VD	A	B	KK	MM	S	SL	VD		
φ32	25	φ34	M16×1.5	φ18	14	10	10	-	-	-	-	-	-	-	-	-	-	-	-	-	-	-	
φ40	30	φ40	M20×1.5	φ22.4	19	11	10	25	φ36	M16×1.5	φ18	14	10	10	35	φ43	M24×1.5	φ28	24	14	17		
φ50	35	φ46	M24×1.5	φ28	24	14	10	30	φ40	M20×1.5	φ22.4	19	11	10	45	φ50	M30×1.5	φ35.5	30	16	17		
φ63	45	φ55	M30×1.5	φ35.5	30	16	10	35	φ46	M24×1.5	φ28	24	14	10	60	φ65	M39×1.5	φ45	41	20	19		
φ80	60	φ65	M39×1.5	φ45	41	20	10	45	φ55	M30×1.5	φ35.5	30	16	9	75	φ80	M48×1.5	φ56	50	23	20		
φ100	75	φ80	M48×1.5	φ56	50	23	10	60	φ65	M39×1.5	φ45	41	20	10	95	φ95	M64×2	φ71	65	27	23		
φ125	95	φ95	M64×2	φ71	65	27	10	75	φ80	M48×1.5	φ56	50	23	10	120	φ115	M80×2	φ90	85	30	17		
φ140	110	φ105	M72×2	φ80	75	31	10	80	φ85	M56×2	φ63	55	24	10	140	φ125	M95×2	φ100	-	Drill hole	17		
φ150	115	φ110	M76×2	φ85	80	33	10	85	φ90	M60×2	φ67	60	30	10	140	φ125	M95×2	φ100	-	Drill hole	15		
φ160	120	φ115	M80×2	φ90	85	33	10	95	φ95	M64×2	φ71	65	27	10	150	φ140	M100×2	φ112	-	Drill hole	16		
φ180	140	φ125	M95×2	φ100	-	Drill hole	10	110	φ105	M72×2	φ80	75	31	10	-	-	-	-	-	-	-	-	
φ200	150	φ140	M100×2	φ112	-	Drill hole	10	120	φ115	M80×2	φ90	85	33	10	-	-	-	-	-	-	-	-	
φ224	180	φ150	M120×2	φ125	-	Drill hole	10	140	φ125	M95×2	φ100	-	Drill hole	10	-	-	-	-	-	-	-	-	
φ250	195	φ170	M130×2	φ140	-	Drill hole	10	150	φ140	M100×2	φ112	-	Drill hole		-	-	-	-	-	-	-	-	

Symbol Bore	BB	BD	E	EE	FP	HL	JR	LZ	Minimum PH		PJ	TD	TL	TM	UM	W		XV		ZJ	
	B·C	A	B·C	A	B·C	A	B·C	A													
φ32	11	28	□58	Rc 3/8	38	141	R2	166	105	-	90	φ20e9	20	58 <sup>0</sup> <sub>-0.3</sub>	98	30	-	113	-	171	-
φ40	11	28	□65	Rc 3/8	38	141	R2	166	105	110	90	φ20e9	20	69 <sup>0</sup> <sub>-0.3</sub>	109	30	35	113	118	171	176
φ50	11	33	□76	Rc 1/2	42	155	R2.5	182	113.5	124.5	98	φ25e9	25	85 <sup>0</sup> <sub>-0.35</sub>	135	30	41	121	132	185	196
φ63	13	43	□90	Rc 1/2	46	163	R2.5	194	127.5	140.5	102	φ31.5e9	31.5	98 <sup>0</sup> <sub>-0.35</sub>	161	35	48	132	145	198	211
φ80	16	43	□110	Rc 3/4	56	184	R2.5	222	140.5	156.5	110	φ31.5e9	31.5	118 <sup>0</sup> <sub>-0.35</sub>	181	35	51	146	162	219	235
φ100	18	53	□135	Rc 3/4	58	192	R3	232	152.5	169.5	116	φ40e9	40	145 <sup>0</sup> <sub>-0.40</sub>	225	40	57	156	173	232	249
φ125	21	58	□165	Rc 1	67	220	R3	264	174	186	130	φ50e9	50	175 <sup>0</sup> <sub>-0.40</sub>	275	45	57	177	189	265	277
φ140	22	78	□185	Rc 1	69	230	R4	276	191	198	138	φ63e9	63	195 <sup>0</sup> <sub>-0.46</sub>	321	50	57	188	195	280	287
φ150	25	78	□196	Rc 1	71	240	R4	288	193	200	146	φ63e9	63	206 <sup>0</sup> <sub>-0.46</sub>	332	50	57	194	201	290	297
φ160	25	88	□210	Rc 1	74	253	R4	304	211	213	156	φ71e9	71	218 <sup>0</sup> <sub>-0.46</sub>	360	55	57	207	209	308	310
φ180	27	98	□235	Rc 1 1/4	75	275	R4	322	225	-	172	φ80e9	80	243 <sup>0</sup> <sub>-0.46</sub>	403	55	-	216	-	330	-
φ200	29	108	□262	Rc 1 1/2	85	301	R5	354	244	-	184	φ90e9	90	272 <sup>0</sup> <sub>-0.52</sub>	452	55	-	232	-	356	-
φ224	34	117	□292	Rc 1 1/2	89	305	R5	362	257.5	-	184	φ100e9	100	300 <sup>0</sup> <sub>-0.52</sub>	500	60	-	241	-	365	-
φ250	37	117	□325	Rc 2	106	346	R5	412	287.5	-	200	φ100e9	100	335 <sup>0</sup> <sub>-0.57</sub>	535	65	-	271	-	411	-

• Allowance of B is h8, allowance of MM is f8.

### With boots

Bore		φ32	φ40	φ50	φ63	φ80	φ100	φ125	φ140	φ150	φ160	φ180	φ200	φ224	φ250
Symbol															
WW	Rod B	40	50	63	71	80	100	125	125	140	140	160	180	180	200
	Rod C	-	50	50	63	71	80	100	125	125	125	125	140	160	180
	Rod A	-	63	71	80	100	125	140	160	160	180	-	-	-	-
X	Rod B	45	45	45	55	55	55	65	65	65	65	65	65	80	80
	Rod C	-	45	45	55	55	55	65	65	65	65	65	65	80	80
	Rod A	-	45	55	55	55	65	65	65	65	65	-	-	-	-

## Switch set

70H-8R	2	SD	Bore	B	B	200	-	A	B	Switch symbol	Switch quantity
140H-8R	2	SD	Bore	B	B	200	-	A	B	Switch symbol	Switch quantity

## AX type (contact), AX type (no contact)

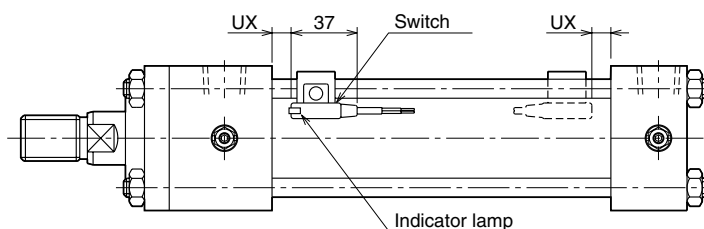
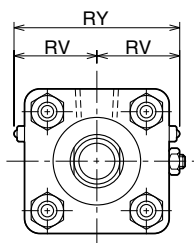

## WR type (contact), WS type (no contact/2-wire, 2-LED type) (cutting fluid proof type)

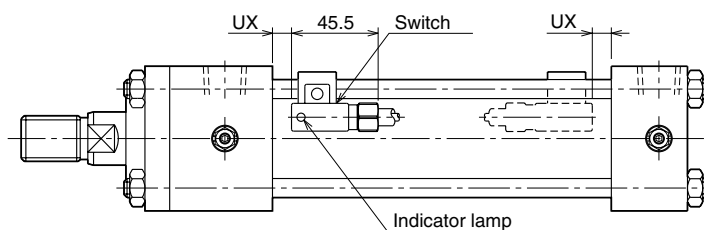
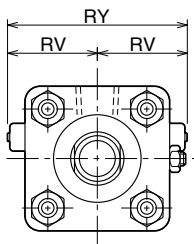

## Minimum dimension PH • PN of switch set cylinder 70/140H-8R

## • TC type

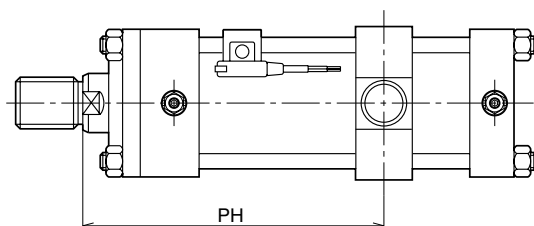

## • FK type

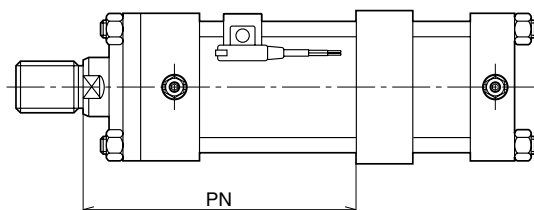

- The minimum dimension PH•PN of the switch set cylinder is the dimension when the trunnion is moved toward the rod side in case that the switch is mounted to the rod side.

If the boots are equipped, the dimension W is modified. In such a case, specify the dimension PH.

**Dimensional table**

Symbol Bore	RV			RY			UX				The minimum dimension PH				The minimum dimension PN			
	AX type AX205W	SR type	WR•WS type	AX type AX205W	SR type	WR•WS type	AX type AX205W	SR type	WR type	WS type	AX type AX205W	SR type	WR type	WS type	AX type AX205W	SR type	WR type	WS type
φ32	36	40	39	72	80	78	13	6	9	12	171	181	190	193	157	167	176	179
φ40	40	46	43	80	92	86	14	6	9	13	171	181	190	193	157	167	176	179
φ50	43	50	47	86	100	94	15	7	9	14	178.5	193.5	198.5	203.5	162	177	182	187
φ63	50	56	53	100	112	106	17	10	13	16	196.5	211.5	216.5	218.5	175	190	195	197
φ80	60	64	63	120	128	126	19	11	13	17	211.5	226.5	229.5	233.5	190	205	208	212
φ100	70	74	72	140	148	144	21	13	14	21	224.5	239.5	242.5	249.5	198	213	216	223
φ125	83	89	85	166	178	170	23	17	19	23	250	265	269	273	221	236	240	244
φ140	91	—	—	182	—	—	26	—	—	—	280	—	—	—	241	—	—	—

Note) The dimension UX indicates the optimum switch mounting position at the detection of the stroke end.

**Working range and difference**

Bore mm	Contact						No contact								
	AX1**		SR type		WR type		AX2**		AX205W		WS type				
	Working range	Difference	Working range	Difference	Working range	Difference	Working range	Difference	Working range	Difference	Working range	Difference			
φ32	4 - 14	2 or less	7 - 10	3 or less	4 - 9	2 or less	3 - 8	1 or less	9 - 12	2 or less	10-14	1 or less			
φ40			7 - 12		6 - 12				11 - 17						
φ50													10 - 16	10 - 17	11-17
φ63			9 - 15		5 - 12				17 - 21						
φ80													11 - 18	11 - 20	—
φ100			—		—				—						
φ125	—	—	—	—	—	—									
φ140	—	—	—	—	—	—									

CAD/DATA is available.  
70-140H-8/TH8 Bore K

## Rod end attachment

## Rod end eye (T-end)

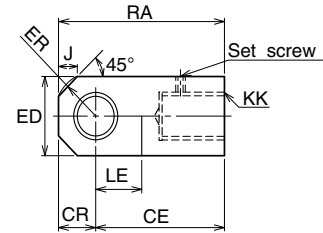
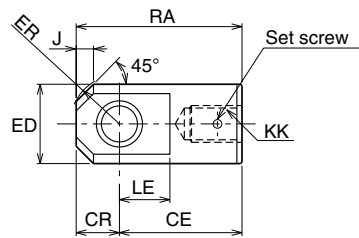
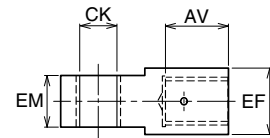
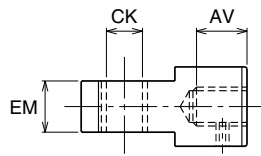
 $\phi 32 - \phi 160$  $\phi 180 - \phi 250$ 

## Eye joint with spherical bearing

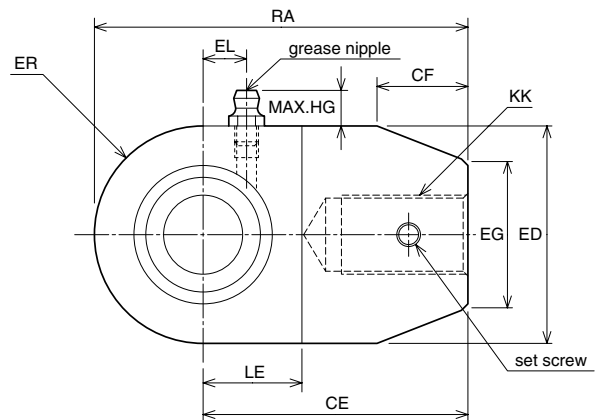
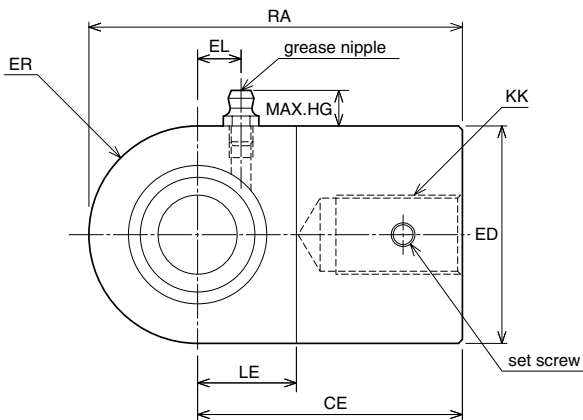
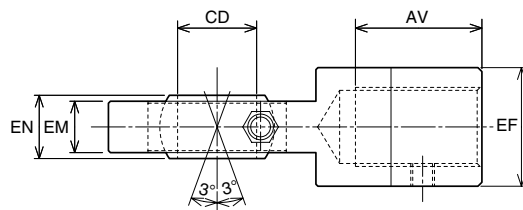
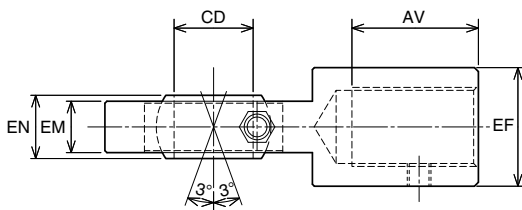
 $\phi 40 - \phi 63$  $\phi 80 - \phi 125$ 

- Notes)
- The grease is not sealed at the shipment. Please properly lubricate the grease nipple.
  - Inner diameter and installation width of bearing are conformed to JIS-B8369 regulation.

**Dimensional table/rod end eye (T-end)**

Symbol Bore	Part code		AV		CE	CK	CR	ED	EF	EM	ER	J	KK		LE	RA
	Rod B	Rod C	Rod B	Rod C									Rod B	Rod C		
φ32	RTH-16-H	—	27	—	60	φ16H10	20	φ39	—	25 <sup>-0.1</sup> <sub>-0.4</sub>	R23	8	M16×1.5	—	23	80
φ40	RTH-20-H	RTH-16-H	32	27	60	φ16H10	20	φ39	—	25 <sup>-0.1</sup> <sub>-0.4</sub>	R23	8	M20×1.5	M16×1.5	23	80
φ50	RTH-24-H	RTH-20-1-H	37	32	70	φ20H10	25	φ49	—	31.5 <sup>-0.1</sup> <sub>-0.4</sub>	R29	10	M24×1.5	M20×1.5	28	95
φ63	RTH-30-H	RTH-24-1-H	47	37	115	φ31.5H10	35	φ62	—	40 <sup>-0.1</sup> <sub>-0.4</sub>	R39	15	M30×1.5	M24×1.5	43	150
φ80	RTH-39-H	RTH-30-H	62	47	115	φ31.5H10	35	φ62	—	40 <sup>-0.1</sup> <sub>-0.4</sub>	R39	15	M39×1.5	M30×1.5	43	150
φ100	RTH-48-H	RTH-39-1-H	77	62	145	φ40H10	40	φ79	—	50 <sup>-0.1</sup> <sub>-0.4</sub>	R45	20	M48×1.5	M39×1.5	55	185
φ125	RTH-64-H	RTH-48-1-H	97	77	180	φ50H10	50	φ100	—	63 <sup>-0.1</sup> <sub>-0.4</sub>	R54	30	M64×2	M48×1.5	65	230
φ140	RTH-72-H	RTH-56-H	112	82	225	φ63H10	65	φ130	—	80 <sup>-0.1</sup> <sub>-0.6</sub>	R74	30	M72×2	M56×2	85	290
φ150	RTH-76-H	RTH-60-H	117	87	225	φ63H10	65	φ130	—	80 <sup>-0.1</sup> <sub>-0.6</sub>	R74	30	M76×2	M60×2	85	290
φ160	RTH-80-H	RTH-64-1-H	122	97	240	φ71H10	70	φ140	—	80 <sup>-0.1</sup> <sub>-0.6</sub>	R77	40	M80×2	M64×2	90	310
φ180	RTH-95-H	RTH-72-1-H	142	112	280	φ80H10	80	160	130	100 <sup>-0.1</sup> <sub>-0.6</sub>	R90	40	M95×2	M72×2	100	360
φ200	RTH-100-H	RTH-80-1-H	152	122	310	φ90H10	90	180	140	125 <sup>-0.1</sup> <sub>-0.6</sub>	R99	50	M100×2	M80×2	120	400
φ224	RTH-120-H	RTH-95-1-H	182	142	370	φ100H10	100	200	170	125 <sup>-0.1</sup> <sub>-0.6</sub>	R112	50	M120×2	M95×2	130	470
φ250	RTH-130-H	RTH-100-1-H	197	152	370	φ100H10	100	200	180	125 <sup>-0.1</sup> <sub>-0.6</sub>	R112	50	M130×2	M100×2	130	470

**Dimensional table/Eye joint with spherical bearing**

Symbol Bore	Part code		AV		CD	CE	CF	ED	EF	EG	EM	EN	ER	KK		LE	RA
	Rod B	Rod C	Rod B	Rod C										Rod B	Rod C		
φ40	RSH-20	RSH-16	32	27	20 <sup>0</sup> <sub>-0.012</sub>	67	—	55	30	—	13	16 <sup>0</sup> <sub>-0.12</sub>	R27.5	M20×1.5	M16×1.5	25	94.5
φ50	RSH-24	RSH-20-1	37	32	25 <sup>0</sup> <sub>-0.012</sub>	78	—	65	35	—	17	20 <sup>0</sup> <sub>-0.12</sub>	R32.5	M24×1.5	M20×1.5	31	110.5
φ63	RSH-30	RSH-24-1	47	37	30 <sup>0</sup> <sub>-0.012</sub>	98	—	80	45	—	19	22 <sup>0</sup> <sub>-0.12</sub>	R40	M30×1.5	M24×1.5	38	138
φ80	RSH-39	RSH-30-1	62	47	40 <sup>0</sup> <sub>-0.012</sub>	125	60	100	55	69	23	28 <sup>0</sup> <sub>-0.12</sub>	R50	M39×1.5	M30×1.5	48	175
φ100	RSH-48	RSH-39-1	77	62	50 <sup>0</sup> <sub>-0.012</sub>	152	50	120	70	93	30	35 <sup>0</sup> <sub>-0.12</sub>	R60	M48×1.5	M39×1.5	58	212
φ125	RSH-64	RSH-48-1	97	77	60 <sup>0</sup> <sub>-0.015</sub>	187	72	150	90	105	38	44 <sup>0</sup> <sub>-0.15</sub>	R75	M64×2	M48×1.5	72	262

**Dimensional table/grease nipple**

Symbol Bore	Rod B			Rod C		
	grease nipple model	EL	HG	grease nipple model	EL	HG
φ40	JIS A type MT6×1	11	11	JIS A type MT6×1	11	11
φ50	JIS A type MT6×1	14	11	JIS A type MT6×1	14	11
φ63	JIS A type Rc1/8	15	15	JIS A type Rc1/8	15	15
φ80	JIS A type Rc1/8	20	15	JIS A type Rc1/8	20	15
φ100	JIS A type Rc1/8	24	15	JIS A type Rc1/8	24	15
φ125	JIS A type Rc1/8	28	15	JIS A type Rc1/8	28	15

## Rod end clevis (Y-end) with pin

φ32 - φ80

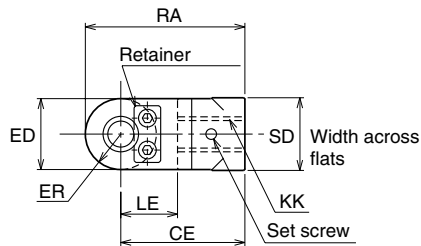
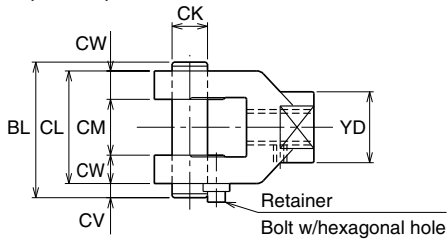

φ100

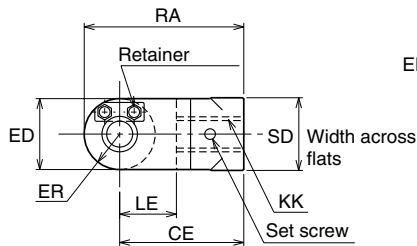
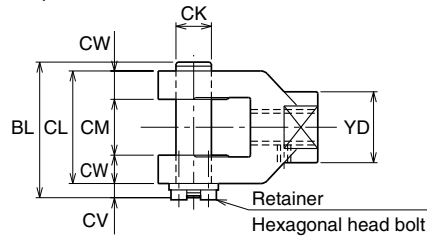

φ125 - φ250

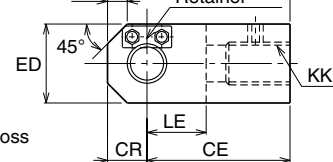
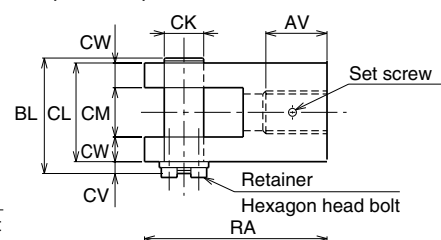

## ● Delivery of rod end attachment (T-end, Y-end)

(1) In the case that the lock nut and rod end attachment are additionally ordered

The rod end attachment and lock nut are temporarily assembled to the piston rod for delivery. Since the lock nut is not tightened, tighten it after the position of the rod end attachment is adjusted. No set screw is included.

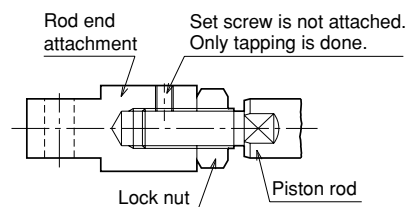

(2) In the case that only the rod end attachment is additionally ordered (without lock nut)

The rod end attachment is tightened to the piston rod, and a drill hole is made on the piston rod for delivery.

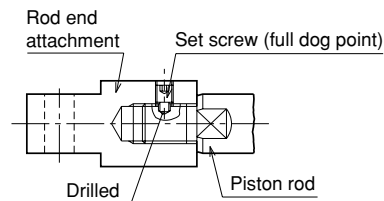

If a drill hole is unnecessary, advise us.

## Floating joint (F-end)

Note) only 70H-8 series

Applicable series

- 70H-8
- 70H-8R
- 70H-8D
- 70H-8RD

- Notes)
- The inserted distance of the floating joint into the socket must be the same as the screw dia. or shorter (screw the joint in, and after it attaches to the end, return it one or two turns, and fix with the lock nut). Excessive insertion may lead to malfunctions.
  - DO NOT use together with the CA, CS, CB, TA, TC and TC accessories.
  - The lock nut is indispensable in using Floating-joint.
  - Please don't miss to order the lock nut with Floating-joint.

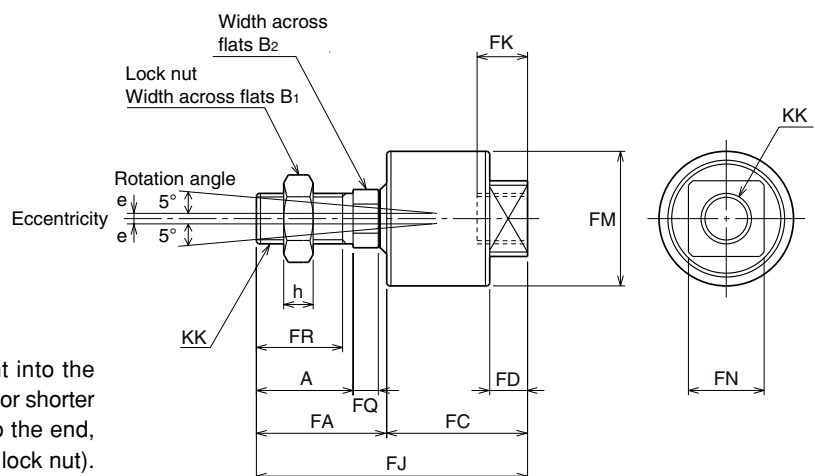



Dimensional table/rod end clevis (Y-end) with pin

Symbol	Part code		AV		BL	CE	CK	CL	CM	CR	CV	CW	ED	ER	J	KK		LE	RA	SD	YD
	Bore	Rod B	Rod C	Rod B												Rod C	Rod B				
φ32	RYH-16-H	—	—	—	62	60	φ16 <sup>H10/18</sup>	50	25 <sup>+0.4/+0.1</sup>	—	7	12.5	32	R16	—	M16x1.5	—	27	76	32	32
φ40	RYH-20-H	RYH-16-H	—	—	62	60	φ16 <sup>H10/18</sup>	50	25 <sup>+0.4/+0.1</sup>	—	7	12.5	32	R16	—	M20x1.5	M16x1.5	27	76	32	32
φ50	RYH-24-H	RYH-20-1-H	—	—	76.5	70	φ20 <sup>H10/18</sup>	63.5	31.5 <sup>+0.4/+0.1</sup>	—	8	16	40	R20	—	M24x1.5	M20x1.5	32	90	41	40
φ63	RYH-30-H	RYH-24-1-H	—	—	93	115	φ31.5 <sup>H10/18</sup>	80	40 <sup>+0.4/+0.1</sup>	—	8	20	60	R30	—	M30x1.5	M24x1.5	50	145	60	60
φ80	RYH-39-H	RYH-30-H	—	—	93	115	φ31.5 <sup>H10/18</sup>	80	40 <sup>+0.4/+0.1</sup>	—	8	20	60	R30	—	M39x1.5	M30x1.5	50	145	60	60
φ100	RYH-48-H	RYH-39-1-H	—	—	117	145	φ40 <sup>H10/18</sup>	100	50 <sup>+0.4/+0.1</sup>	—	12	25	80	R40	—	M48x1.5	M39x1.5	60	185	80	80
φ125	RYH-64-H	RYH-48-1-H	97	77	143	180	φ50 <sup>H10/18</sup>	126	63 <sup>+0.4/+0.1</sup>	50	12	31.5	100	R54	30	M64x2	M48x1.5	70	230	—	—
φ140	RYH-72-H	RYH-56-H	112	82	183	225	φ63 <sup>H10/18</sup>	160	80 <sup>+0.6/+0.1</sup>	65	18	40	120	R72	30	M72x2	M56x2	90	290	—	—
φ150	RYH-76-H	RYH-60-H	117	87	183	225	φ63 <sup>H10/18</sup>	160	80 <sup>+0.6/+0.1</sup>	65	18	40	120	R72	30	M76x2	M60x2	90	290	—	—
φ160	RYH-80-H	RYH-64-1-H	122	97	183	240	φ71 <sup>H10/18</sup>	160	80 <sup>+0.6/+0.1</sup>	70	18	40	140	R77	40	M80x2	M64x2	100	310	—	—
φ180	RYH-95-H	RYH-72-1-H	142	112	210	280	φ80 <sup>H10/18</sup>	180	100 <sup>+0.6/+0.1</sup>	80	24	40	160	R90	40	M95x2	M72x2	110	360	—	—
φ200	RYH-100-H	RYH-80-1-H	152	122	260	310	φ90 <sup>H10/18</sup>	230	125 <sup>+0.6/+0.1</sup>	90	24	52.5	180	R99	50	M100x2	M80x2	130	400	—	—
φ224	RYH-120-H	RYH-95-1-H	182	142	280	370	φ100 <sup>H10/18</sup>	250	125 <sup>+0.6/+0.1</sup>	100	24	62.5	200	R112	50	M120x2	M95x2	140	470	—	—
φ250	RYH-130-H	RYH-100-1-H	197	152	280	370	φ100 <sup>H10/18</sup>	250	125 <sup>+0.6/+0.1</sup>	100	24	62.5	200	R112	50	M130x2	M100x2	140	470	—	—

Note) If you vertically fix the Rod end clevis (Y-end) with pin in LC mounting, it will cause interference with the rib of the LC mounting.  
Please feel free to contact us for the solution.

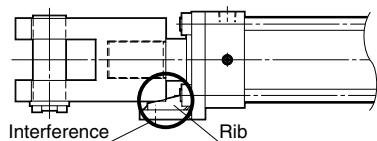

Dimensional table/floating joint (F-end)

Applicable bore		Part code	A	B1	B2	e	FA	FC	FD	FJ	FK	FM	FN	FQ	FR	h	KK
Rod B	Rod C																
φ32	φ40	RFH-16	32	22	17	1.5	43	46	13	89	16	φ40	24	8	28	10	M16x1.5
φ40	φ50	RFH-20	40	27	22	2	53	57	15	110	22	φ50	30	9	35	12	M20x1.5
φ50	φ63	RFH-24	46	32	24	2.5	62	67	18	129	24	φ64	36	12	41	14	M24x1.5
φ63	φ80	RFH-30	58	41	32	2.5	78	83	21	161	30	φ76	46	14	52	17	M30x1.5

## Parallel pin

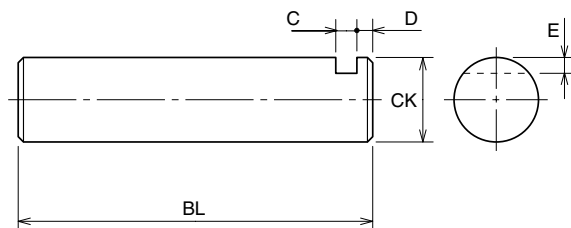

## Keeper plate

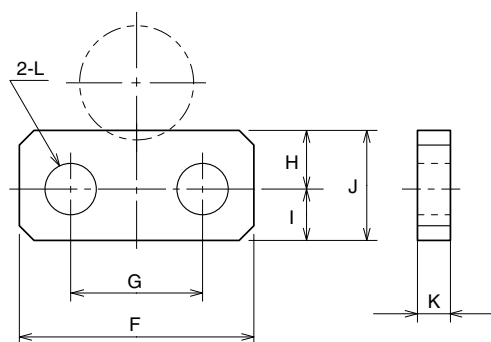

Dimensional table/Parallel pin

Symbol Bore	BL	C	CK	D	E
φ32	62	4	φ16	3	3
φ40	62	4	φ16	3	3
φ50	76.5	5	φ20	3	3
φ63	93	5	φ31.5	3	4.75
φ80	93	5	φ31.5	3	4.75
φ100	117	7	φ40	5	5
φ125	143	7	φ50	5	5
φ140	183	10	φ63	8	8
φ150	183	10	φ63	8	8
φ160	183	10	φ71	8	8

• Allowance of CK is f8.

Dimensional table/Keeper plate

Symbol Bore	F	G	H	I	J	K	L	Volt size
φ32	25	14	7	6	13	3	φ6.5	M6
φ40	25	14	7	6	13	3	φ6.5	M6
φ50	32	18	8	7	15	4.5	φ7	M6
φ63	32	18	8	7	15	4.5	φ7	M6
φ80	32	18	8	7	15	4.5	φ7	M6
φ100	50	30	10	8	18	6	φ10	M8
φ125	65	40	12	10	22	6	φ12	M10
φ140	75	48	17	13	30	9	φ14	M12
φ150	75	48	17	13	30	9	φ14	M12
φ160	75	48	17	13	30	9	φ14	M12

70-140H-8/TH8

Bore K

CAD/DATA is  
available.

### When rod end attachment is required (rod dia. A type)

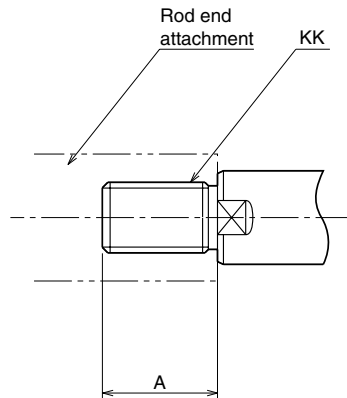

- It is recommended to modify the thread dia., dimension KK, to that of the rod B (Ex.: for 50 mm dia., M30 × 1.5 → M24 × 1.5), and attach the rod end attachment for the rod B. In such a case, specify the dimensions, A and KK.

### Lock nut

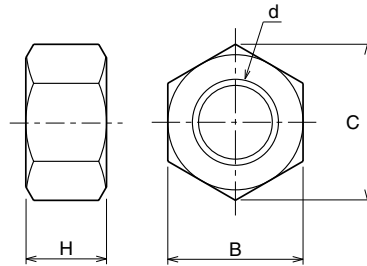

- The type with a bore of  $\phi 180$  or more is also within the semi-standard fabrication range.

The guide of the fitting length of the rod end attachment and piston rod is approx. 80% of the thread dia. If the fitting length is insufficient when the lock nut is used, it is required to lengthen the thread length (dimension A) as shown in the figure below.

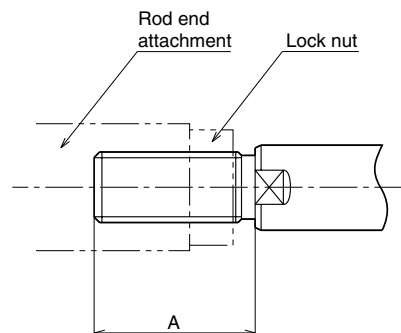

**7/14 MPa double acting hydraulic cylinder**  
**Double acting single rod/double rod**

Unit: mm

**70/140H-8**

**Dimensional table**

Symbol Bore	Rod A thread part dimensions		Rod B thread part dimensions		Rod end attachment parts code in the case of the thread dimensions of rod B		
	A	KK	A	KK	Rod end eye	Rod end clevis	F-joint
φ40	35	M24×1.5	30	M20×1.5	RTH-20-H	RYH-20-H	RFH-20
φ50	45	M30×1.5	35	M24×1.5	RTH-24-H	RYH-24-H	RFH-24
φ63	60	M39×1.5	45	M30×1.5	RTH-30-H	RYH-30-H	RFH-30
φ80	75	M48×1.5	60	M39×1.5	RTH-39-H	RYH-39-H	—
φ100	95	M64×2	75	M48×1.5	RTH-48-H	RYH-48-H	—
φ125	120	M80×2	95	M64×2	RTH-64-H	RYH-64-H	—
φ140	140	M95×2	110	M72×2	RTH-72-H	RYH-72-H	—
φ150	140	M95×2	115	M76×2	RTH-76-H	RYH-76-H	—
φ160	150	M100×2	120	M80×2	RTH-80-H	RYH-80-H	—

**Dimensional table/lock nut**







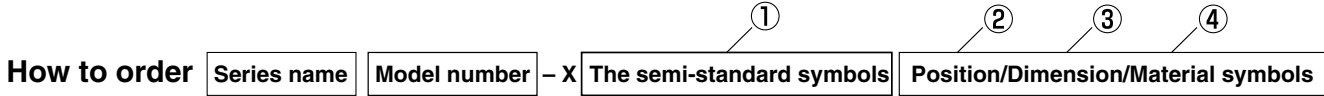

Symbol Bore	Rod B					Rod C					Rod A				
	Parts code	B	C	d	H	Parts code	B	C	d	H	Parts code	B	C	d	H
φ32	LNH-16F-H	22	25.4	M16×1.5	10	—	—	—	—	—	—	—	—	—	—
φ40	LNH-20F-H	27	31.2	M20×1.5	12	LNH-16F-H	22	25.4	M16×1.5	10	LNH-24F-H	32	37.0	M24×1.5	14
φ50	LNH-24F-H	32	37.0	M24×1.5	14	LNH-20F-H	27	31.2	M20×1.5	12	LNH-30F-H	41	47.3	M30×1.5	17
φ63	LNH-30F-H	41	47.3	M30×1.5	17	LNH-24F-H	32	37.0	M24×1.5	14	LNH-39F-H	55	63.5	M39×1.5	20
φ80	LNH-39F-H	55	63.5	M39×1.5	20	LNH-30F-H	41	47.3	M30×1.5	17	LNH-48F-H	70	80.8	M48×1.5	26
φ100	LNH-48F-H	70	80.8	M48×1.5	26	LNH-39F-H	55	63.5	M39×1.5	20	LNH-64F-H	90	104	M64×2	35
φ125	LNH-64F-H	90	104	M64×2	35	LNH-48F-H	70	80.8	M48×1.5	26	LNH-80F-H	110	127	M80×2	43
φ140	LNH-72F-H	100	115	M72×2	38	LNH-56F-H	80	92.4	M56×2	30	LNH-95F-H	130	150	M95×2	47
φ150	LNH-76F-H	105	121	M76×2	40	LNH-60F-H	85	98.1	M60×2	33	LNH-95F-H	130	150	M95×2	47
φ160	LNH-80F-H	110	127	M80×2	43	LNH-64F-H	90	104	M64×2	35	LNH-100F-H	135	156	M100×2	50
φ180	LNH-95F-H	130	150	M95×2	47	LNH-72F-H	100	115	M72×2	38	—	—	—	—	—
φ200	LNH-100F-H	135	156	M100×2	50	LNH-80F-H	110	127	M80×2	43	—	—	—	—	—
φ224	LNH-120F-H	165	191	M120×2	60	LNH-95F-H	130	150	M95×2	47	—	—	—	—	—
φ250	LNH-130F-H	180	208	M130×2	65	LNH-100F-H	135	156	M100×2	50	—	—	—	—	—

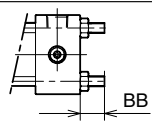
Symbol Bore	Dimension A		
	Rod A	Rod B	Rod C
φ32	—	40	—
φ40	50	45	40
φ50	60	50	45
φ63	80	60	50
φ80	95	80	60
φ100	125	95	80
φ125	155	125	95
φ140	180	140	105
φ150	180	150	120
φ160	190	155	125
φ180	—	180	140
φ200	—	190	155
φ224	—	230	180
φ250	—	250	190

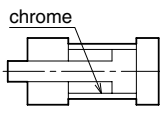
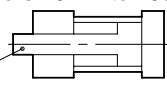
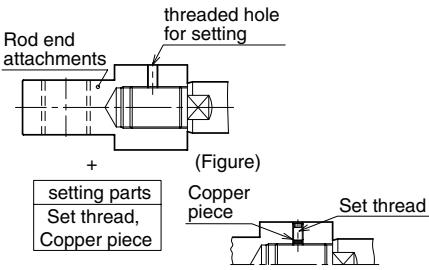
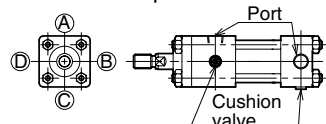
### ★ Easy ordering system

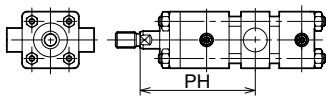
The following contents can be easily specified using the Semi-standard symbols and the (Position/Dimension/Material) symbols.

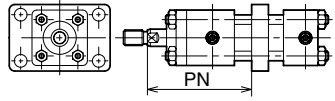

Easy order contents	① The semi-standard symbols	Position		Dimension		Material	
		② Symbol	contents	③ Symbol	contents	④ Symbol	contents
Tie rods extension Note1) Tolerance of BB dimension is approximately due to tie rod's stretch. It should be consulted us in case of precise BB dimension necessary. 2) LB, LC Only 2, end side and upper, tie rods can be extended. Flange, Clevis mounting Only one side's 4 tie rods without mounting bracket can be extended.	 STD	TD-RS TD-HS TD-BS	Head cap side End cap side Both sides	BB-  Maximum BB for semi-standard is 70mm.	—	—	—
ex. In case of selecting SD mounting and tie rods extension on both sides to be 50mm. 70H-8R 2SD80BB100-ABAH2-X STD TD-BS, BB-50	ex.						
Hard chrome plated on inside of cylinder tubing (Only for carbon steel tube) Note) Consult us for any special thickness of chrome plating except 0.02mm.	 STB	—	—	BG-0.02	Thickness of chrome plating 0.02mm	—	—
ex. 70H-8 2LB80BB100-AB-X STB BG-0.02	ex.						
Stainless steel rod (bore:40mm to 100mm) Note) Consult us for any special requirement except material SUS304 or 0.02mm thickness of chrome plating.	 SPR	—	—	—	—	PR-10	Material:SUS304 Thickness of chrome plating 0.02mm
ex. 70H-8R 2LB80BB100-ABAH2-X SPR PR-10	ex.						
Rod end attachments (T,Y,S) with a set screw and a copper piece (bore:32mm to 160mm) Rod end attachments threaded hole for setting + setting parts Set thread, Copper piece (Figure) Copper piece Set thread drilled hole	 MDC	—	—	—	—	—	—
ex. Occasion) In order to receive the cylinder and the rod end attachment separately. (Just temporary assembly) 70H-8R 2CB80BB100-ABAH2-T-X MDC Reference) Without the order of MDC, the attachment is fixed as below at shipment. Reference) Without the order of MDC, the attachment is fixed as below at shipment. After fine adjustment, please be sure to fix the attachment using a copper piece and a screw. ★Validity of the way to fix the attachment coated with adhesive might not be multirole. Please be sure to fasten it to avoid the trouble.	ex.						
Changing the location of the port and cushion needle on the end cap side  PPC	PC-  Port/Cushion needle location on end cap side	—	—	—	—	—	—
ex. Phase changed Port/Cushion needle on both sides. 70H-8 2LA80BB100-AB-X PPC PC-BC	ex.						
Water-glycol working fluid Note1) Carbon steel tubing has hard chrome plated on inside and the water-glycol fluid is used for testing. 2) Stainless steel tubing has no chromem plated and the water-glycol fluid is used for testing.	FWF	—	—	—	—	WF-WG	WF-WG: Water-glycol working fluid
ex. 70H-8 6LB80BB100-AB-X FWF WF-WG	ex.						
Trunion location change (PH dimension)  MTC	TCPH-  should be specified by the integral number.	—	—	—	—	—	—
ex. In case of 360mm PH dimension 70H-8R 2TC63BB500-AB-X MTC TCPH-360	ex.						
Intermediate flange location change (PN dimension)  MFK	FKPN-  should be specified by the integral number.	—	—	—	—	—	—
ex. In case of 1100mm PN dimension 140H-8 2FK80BB1800-AB-X MFK FKPN-1100	ex.						

# 7/14 MPa double acting hydraulic cylinder

## Double acting single rod/double rod

Unit: mm

# 70/140H-8

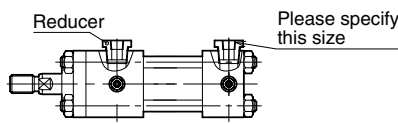
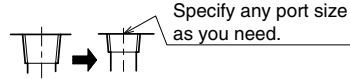
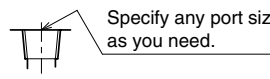
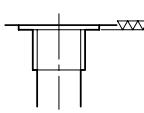
Special order contents	① The semi-standard symbols	Position		Dimension		Material								
		② Symbol	contents	③ Symbol	contents	④ Symbol	contents							
<b>Additional bushing</b>    Note1) Please specify the reduced port size as dimensional data. Note2) Only one or two steps reducing can be specified on this system. Any other case, please consult us.	PBS	—	—	RC-1.00	Rc1/8	—	—							
				RC-2.00	Rc1/4									
				RC-3.00	Rc3/8									
				RC-4.00	Rc1/2									
				RC-6.00	Rc3/4									
				RC-8.00	Rc1									
				RC-10.00	Rc1 1/4									
				RC-12.00	Rc1 1/2									
	ex.	140H-8, CA mounting, bore:80mm (Standard port:Rc3/4) is going to be Rc1/2 port. (one step reducing) 140H-8 2CA80BB300-AB-X PBS RC-4.00												
<b>Rc port size below standard (bore:32mm to 160mm)</b>  ★ In case of port size below standard necessary without reducer    You can't use this symbol at : ● all A rod variations ● B, C rod with LA mounting	① The semi-standard symbols	Only dimensional data is required.		Counter-chart of cylinder bore size and optional port size(◎: Standard port size)										
		③ Symbol	contents	32	40	50	63	80	100	125	140	150	160	
		RC-1.00	Rc1/8	○	○	×	×	×	×	×	×	×	×	×
		RC-2.00	Rc1/4	○	○	○	○	×	×	×	×	×	×	×
		RC-3.00	Rc3/8	◎	◎	○	○	○	○	×	×	×	×	×
		RC-4.00	Rc1/2	×	×	◎	◎	○	○	○	○	○	○	○
		RC-6.00	Rc3/4	×	×	×	×	◎	◎	○	○	○	○	○
		RC-8.00	Rc1	×	×	×	×	×	×	◎	◎	◎	◎	◎
RC-10.00	Rc1 1/4	×	×	×	×	×	×	×	×	×	×	×		
	ex.	bore:63mm (standard port Rc1/2), without bushing is going to be Rc3/8 port. 70H-8R 2CA80BB100-ABAH2-X PRT RC-3.00												
<b>Cover port size reducing (for NPT) (bore:32mm to 160mm)</b>  Note) Optional port size range is common to the Rc port.    You can't use this symbol at : ● all A rod variations ● B, C rod with LA mounting	① The semi-standard symbols	Only dimensional data is required.		Counter-chart of cylinder bore size and optional port size(◎: Standard port size)										
		③ Symbol	contents	32	40	50	63	80	100	125	140	150	160	
		N-1.00	NPT1/8	○	○	×	×	×	×	×	×	×	×	×
		N-2.00	NPT1/4	○	○	○	○	×	×	×	×	×	×	×
		N-3.00	NPT3/8	◎	◎	○	○	○	○	×	×	×	×	×
		N-4.00	NPT1/2	×	×	◎	◎	○	○	○	○	○	○	○
		N-6.00	NPT3/4	×	×	×	×	◎	◎	○	○	○	○	○
		N-8.00	NPT1	×	×	×	×	×	×	◎	◎	◎	◎	◎
N-10.00	NPT1 1/4	×	×	×	×	×	×	×	×	×	×	×		
	Note	The way to order the standard port size(◎) is showed in the article below.												
	ex.	bore:50mm (standard port NPT1/2) is going to be NPT3/8 port. 70H-8 2CB50BB100-NAB-X PTN N-3.00												
<b>G / NPT port (bore:32mm to 160mm) (Only for standard size G or NPT)</b>  	Standard size G or NPT can be easily ordered as below.  ex.) 70H-8 2LA50BB100- G A B -TL G:G screw piping port type N:NPT screw type Port position Location of cushion needle													

### Special specification at the rod end

■ You can easily order following categorized items using the Semi-standard symbols and dimensional parameters.  
(No need to specify dimensional parameters if you would apply the basic dimensions.)

**How to order** Series name Model number - X The semi-standard symbols Dimensional parameters

Parameter KM and KP need to be specified as a pair.

ex.1) **A53**

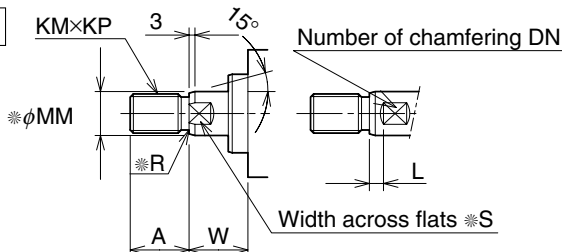

- ϕ63C Rod end shape A53, A=50, W=50, thread M22×1.5, Number of chamfering 2, position of flats L = 10
- 70H-8 2FA63CB200-AB-X A53
- A-50, KM-22, KP-1.5, L-10, W-50

ex.2) **A54**

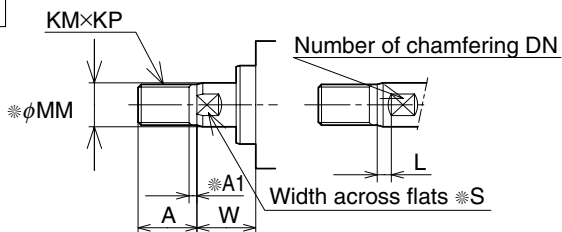

- ϕ63C Rod end shape A54, basic dimensions
- 140H-8 2LA63BC500-BC-X A54

Note) For the A54 type, if the dimensions KM and KP are modified, the dimension A1 is modified as shown in the table below.

KP (pitch)	Dimension A1
1.75 or less	4
2	5
2.5 or more	KP (pitch) × 2

### Special rod end shape type (rod C)

**A00**

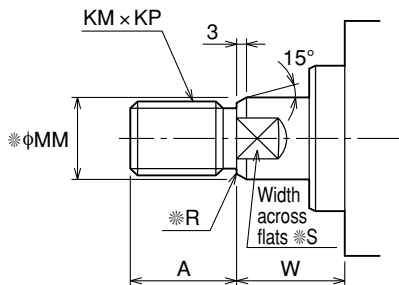

Basic dimensional table (standard dimensions)

Bore	A	KM	KP	ϕMM	ϕR	ϕS	W
ϕ40	25	M16	1.5	ϕ18	1	14	30
ϕ50	30	M20	1.5	ϕ22.4	1	19	30
ϕ63	35	M24	1.5	ϕ28	1	24	35
ϕ80	45	M30	1.5	ϕ35.5	1.6	30	35
ϕ100	60	M39	1.5	ϕ45	1.6	41	40
ϕ125	75	M48	1.5	ϕ56	1.6	50	45
ϕ140	80	M56	2	ϕ63	2	55	50
ϕ150	85	M60	2	ϕ67	2	60	50
ϕ160	95	M64	2	ϕ71	2	65	55
ϕ180	110	M72	2	ϕ80	2	75	55
ϕ200	120	M80	2	ϕ90	2	85	55
ϕ224	140	M95	2	ϕ100	2	Drill	60
ϕ250	150	M100	2	ϕ112	2	hole	65

**A51**

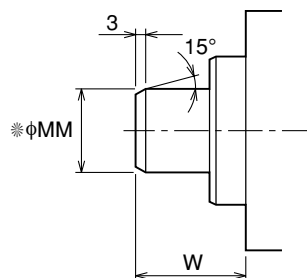

Basic dimensional table

Bore	ϕMM	W
ϕ40	ϕ18	30
ϕ50	ϕ22.4	30
ϕ63	ϕ28	35
ϕ80	ϕ35.5	35
ϕ100	ϕ45	40
ϕ125	ϕ56	45
ϕ140	ϕ63	50
ϕ150	ϕ67	50
ϕ160	ϕ71	55
ϕ180	ϕ80	55
ϕ200	ϕ90	55
ϕ224	ϕ100	60
ϕ250	ϕ112	65

• Dimensions indicated by \* Mark are fixed as our semi-standard.  
• You are requested to consult us if you would like to change fixed dimensions.



Unit: mm

**A53**

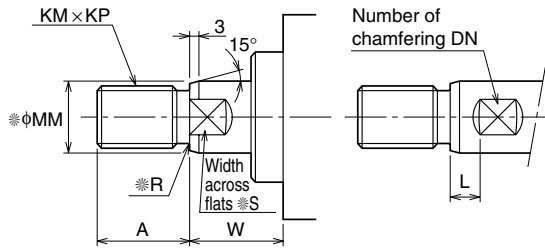

**Basic dimensional table**

Bore	A	DN	KM	KP	L	$\phi MM$	$\phi R$	$\phi S$	W
$\phi 40$	25	2	M16	1.5	0	$\phi 18$	1	14	30
$\phi 50$	30	2	M20	1.5	0	$\phi 22.4$	1	19	30
$\phi 63$	35	2	M24	1.5	0	$\phi 28$	1	24	35
$\phi 80$	45	2	M30	1.5	0	$\phi 35.5$	1.6	30	35
$\phi 100$	60	2	M39	1.5	0	$\phi 45$	1.6	41	40
$\phi 125$	75	2	M48	1.5	0	$\phi 56$	1.6	50	45
$\phi 140$	80	2	M56	2	0	$\phi 63$	2	55	50
$\phi 150$	85	2	M60	2	0	$\phi 67$	2	60	50
$\phi 160$	95	2	M64	2	0	$\phi 71$	2	65	55

Use this type when the width across flats S of the A00 are required to be moved.

**A54**

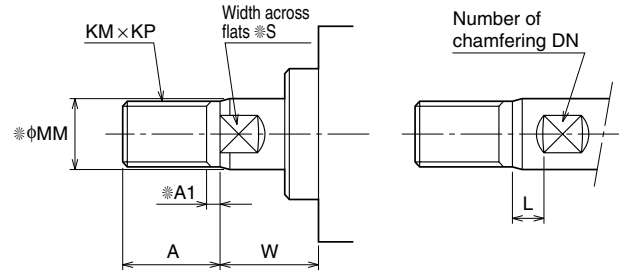

**Basic dimensional table**

Bore	A	$\phi A1$	DN	KM	KP	L	$\phi MM$	$\phi S$	W
$\phi 40$	25	4	2	M16	1.5	0	$\phi 18$	14	30
$\phi 50$	30	4	2	M20	1.5	0	$\phi 22.4$	19	30
$\phi 63$	35	4	2	M24	1.5	0	$\phi 28$	24	35
$\phi 80$	45	4	2	M30	1.5	0	$\phi 35.5$	30	35
$\phi 100$	60	4	2	M39	1.5	0	$\phi 45$	41	40
$\phi 125$	75	4	2	M48	1.5	0	$\phi 56$	50	45
$\phi 140$	80	5	2	M56	2	0	$\phi 63$	55	50
$\phi 150$	85	5	2	M60	2	0	$\phi 67$	60	50
$\phi 160$	95	5	2	M64	2	0	$\phi 71$	65	55
$\phi 180$	110	5	2	M72	2	0	$\phi 80$	75	55
$\phi 200$	120	5	2	M80	2	0	$\phi 90$	85	55
$\phi 224$	140	5	Drill hole	M95	2	Drill hole	$\phi 100$	Drill hole	60
$\phi 250$	150	5	Drill hole	M100	2	Drill hole	$\phi 112$	Drill hole	65

General purpose hydraulic cylinder

**A81**

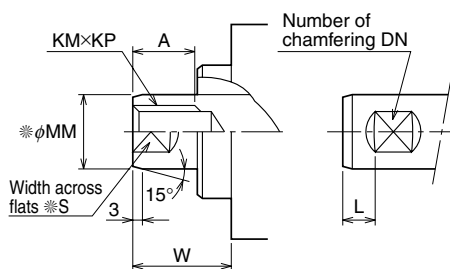

**Basic dimensional table**

Bore	A	DN	KM	KP	L	$\phi MM$	$\phi S$	W
$\phi 40$	15	2	M12	1.75	0	$\phi 18$	14	30
$\phi 50$	20	2	M16	2	0	$\phi 22.4$	19	30
$\phi 63$	24	2	M20	2.5	0	$\phi 28$	24	35
$\phi 80$	33	2	M27	3	0	$\phi 35.5$	30	35
$\phi 100$	36	2	M30	3.5	0	$\phi 45$	41	40
$\phi 125$	45	2	M39	4	0	$\phi 56$	50	45
$\phi 140$	54	2	M45	2	0	$\phi 63$	55	50
$\phi 150$	54	2	M45	2	0	$\phi 67$	60	50
$\phi 160$	58	2	M48	2	0	$\phi 71$	65	55

This type of shape is applicable to only the 7 MPa type. For the 14 MPa type, contact us.

Note) • The possible number of chamfering DN is 2 (standard) or 4 only.

- Dimensions indicated by \* Mark are fixed as our semi-standard.
- You are requested to consult us if you would like to change fixed dimensions.

### Special rod end shape type (rod B)

#### A00

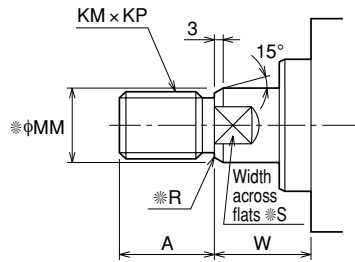

Basic dimensional table (standard dimensions)

Bore	A	KM	KP	φMM	R	S	W
φ32	25	M16	1.5	φ18	1	14	30
φ40	30	M20	1.5	φ22.4	1	19	30
φ50	35	M24	1.5	φ28	1	24	30
φ63	45	M30	1.5	φ35.5	1.6	30	35
φ80	60	M39	1.5	φ45	1.6	41	35
φ100	75	M48	1.5	φ56	1.6	50	40
φ125	95	M64	2	φ71	2	65	45
φ140	110	M72	2	φ80	2	75	50
φ150	115	M76	2	φ85	2	80	50
φ160	120	M80	2	φ90	2	85	55
φ180	140	M95	2	φ100	2		55
φ200	150	M100	2	φ112	2	Drill hole	55
φ224	180	M120	2	φ125	2	hole	60
φ250	195	M130	2	φ140	2		65

Note) ● The possible number of chamfering DN is 2 (standard) or 4 only.

#### A51

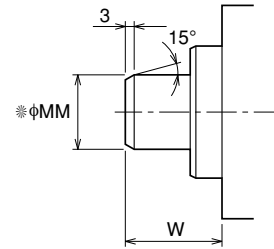

Basic dimensional table

Bore	φMM	W
φ32	φ18	30
φ40	φ22.4	30
φ50	φ28	30
φ63	φ35.5	35
φ80	φ45	35
φ100	φ56	40
φ125	φ71	45
φ140	φ80	50
φ150	φ85	50
φ160	φ90	55
φ180	φ100	55
φ200	φ112	55
φ224	φ125	60
φ250	φ140	65

General purpose hydraulic cylinder

#### A53

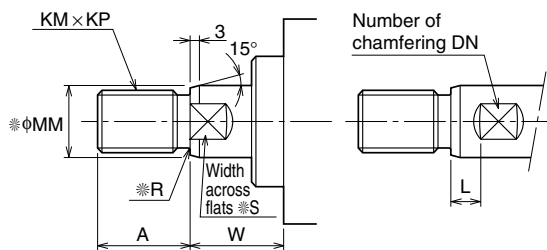

Basic dimensional table

Bore	A	DN	KM	KP	L	φMM	R	S	W
φ32	25	2	M16	1.5	0	φ18	1	14	30
φ40	30	2	M20	1.5	0	φ22.4	1	19	30
φ50	35	2	M24	1.5	0	φ28	1	24	30
φ63	45	2	M30	1.5	0	φ35.5	1.6	30	35
φ80	60	2	M39	1.5	0	φ45	1.6	41	35
φ100	75	2	M48	1.5	0	φ56	1.6	50	40
φ125	95	2	M64	2	0	φ71	2	65	45
φ140	110	2	M72	2	0	φ80	2	75	50
φ150	115	2	M76	2	0	φ85	2	80	50
φ160	120	2	M80	2	0	φ90	2	85	55

Use this type when the width across flats S of the A00 are required to be moved.

- Dimensions indicated by \* Mark are fixed as our semi-standard.
- You are requested to consult us if you would like to change fixed dimensions.

# 7/14 MPa double acting hydraulic cylinder

## Double acting single rod/double rod

Unit: mm

# 70/140H-8

### A54

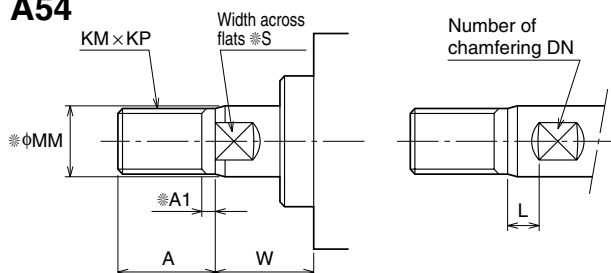

**Basic dimensional table**

Bore	A	※A1	DN	KM	KP	L	※MM	※S	W
φ32	25	4	2	M16	1.5	0	φ18	14	30
φ40	30	4	2	M20	1.5	0	φ22.4	19	30
φ50	35	4	2	M24	1.5	0	φ28	24	30
φ63	45	4	2	M30	1.5	0	φ35.5	30	35
φ80	60	4	2	M39	1.5	0	φ45	41	35
φ100	75	4	2	M48	1.5	0	φ56	50	40
φ125	95	5	2	M64	2	0	φ71	65	45
φ140	110	5	2	M72	2	0	φ80	75	50
φ150	115	5	2	M76	2	0	φ85	80	50
φ160	120	5	2	M80	2	0	φ90	85	55
φ180	140	5		M95	2		φ100		55
φ200	150	5	Drill hole	M100	2	Drill hole	φ112	Drill hole	55
φ224	180	5		M120	2		φ125		60
φ250	195	5		M130	2		φ140		65

Note) ● The possible number of chamfering DN is 2 (standard) or 4 only.

### A55

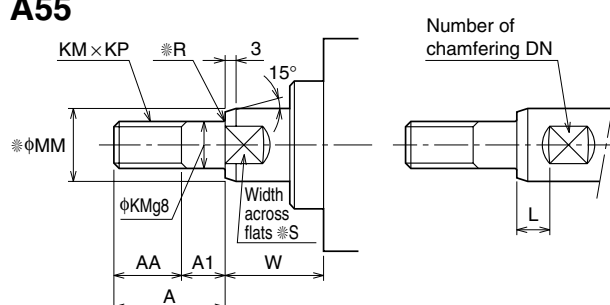

**Basic dimensional table**

Bore	A	AA	A1	DN	KM	KP	L	※MM	※R	※S	W
φ50	44	30	14	2	M20	1.5	0	φ28	1.6	24	30
φ63	49	35	14	2	M24	1.5	0	φ35.5	2	30	35
φ80	59	45	14	2	M30	1.5	0	φ45	2	41	35
φ100	74	60	14	2	M39	1.5	0	φ56	2	50	40
φ125	89	75	14	2	M48	1.5	0	φ71	2.5	65	45
φ140	100	80	20	2	M56	2	0	φ80	2.5	75	50
φ150	105	85	20	2	M60	2	0	φ85	2.5	80	50
φ160	115	95	20	2	M64	2	0	φ90	2.5	85	55

For the products of a bore of φ32 and φ40, basic dimensions have not been specified.

Contact us when you request for them.

When modifying the dimension A1, specify the number of 10 or more.

Specify the dimensions AA and A1 at the same time.

### A81

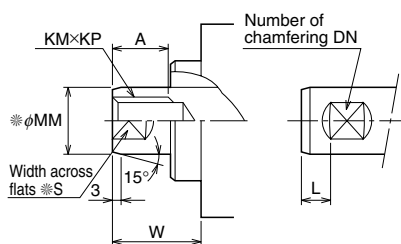

**Basic dimensional table**

Bore	A	DN	KM	KP	L	※MM	※S	W
φ32	15	2	M12	1.75	0	φ18	14	30
φ40	20	2	M16	2	0	φ22.4	19	30
φ50	24	2	M20	2.5	0	φ28	24	30
φ63	33	2	M27	3	0	φ35.5	30	35
φ80	36	2	M30	3.5	0	φ45	41	35
φ100	45	2	M39	4	0	φ56	50	40
φ125	58	2	M48	2	0	φ71	65	45
φ140		2			0	φ80	75	50
φ150		2			0	φ85	80	50
φ160		2			0	φ90	85	55

For the products of a bore from φ140 to φ160, basic dimensions have not been specified. When ordering them, fill the blank areas in the table above.

### A82

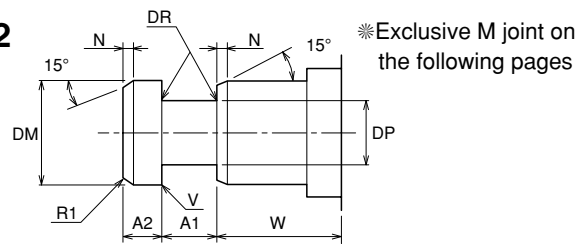

**Basic dimensional table**

Bore	※A1 <sup>+0.5/-0.3</sup>	※A2 <sup>-0.2/-0.3</sup>	※DM	※DP <sup>-0.2/-0.3</sup>	※DR	※MM	※N	※V	W
φ32	12.5	12.5	φ18	φ13	1.0	φ18	3	C0.2	30
φ40	12.5	12.5	φ22.4	φ16	1.5	φ22.4	3	C0.2	30
φ50	12.5	12.5	φ28	φ21	1.5	φ28	3	C0.2	30
φ63	15	15	φ35.5	φ26	2.0	φ35.5	3	C0.2	35
φ80	15	15	φ45	φ31	2.0	φ45	3	C0.2	35
φ100	20	20	φ56	φ38	3.0	φ56	3	C0.2	40
φ125	25	25	φ71	φ49	3.5	φ71	3	R1	45
φ140	25	25	φ80	φ56	4.0	φ80	3	R1	50
φ150	30	30	φ85	φ58	5.0	φ85	6	R1	50
φ160	30	30	φ90	φ60	5.0	φ90	6	R1	55

MM is rod dia.

- Dimensions indicated by ※ Mark are fixed as our semi-standard.
- You are requested to consult us if you would like to change fixed dimensions.

## Special rod end shape type (rod A)

## A00

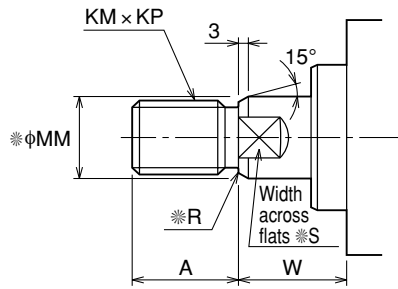

Basic dimensional table (standard dimensions)

Bore	A	KM	KP	φMM	φR	φS	W
φ40	35	M24	1.5	φ28	1	24	35
φ50	45	M30	1.5	φ35.5	1.6	30	41
φ63	60	M39	1.5	φ45	1.6	41	48
φ80	75	M48	1.5	φ56	1.6	50	51
φ100	95	M64	2	φ71	2	65	57
φ125	120	M80	2	φ90	2	85	57
φ140	140	M95	2	φ100	2	Drill hole	57
φ150	140	M95	2	φ100	2		57
φ160	150	M100	2	φ112	2		57

## A51

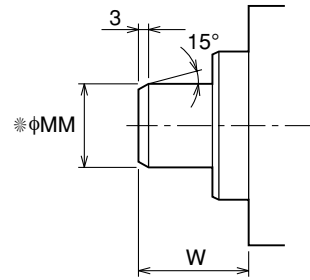

Basic dimensional table

Bore	φMM	W
φ40	φ28	35
φ50	φ35.5	41
φ63	φ45	48
φ80	φ56	51
φ100	φ71	57
φ125	φ90	57
φ140	φ100	57
φ150	φ100	57
φ160	φ112	57

## A53

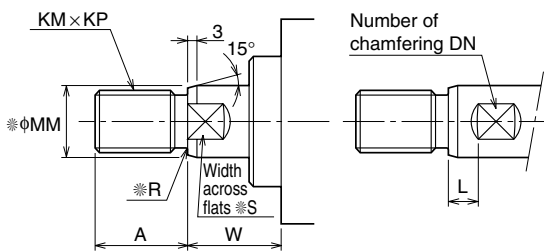

Basic dimensional table

Bore	A	DN	KM	KP	L	φMM	φR	φS	W
φ40	35	2	M24	1.5	0	φ28	1	24	35
φ50	45	2	M30	1.5	0	φ35.5	1.6	30	41
φ63	60	2	M39	1.5	0	φ45	1.6	41	48
φ80	75	2	M48	1.5	0	φ56	1.6	50	51
φ100	95	2	M64	2	0	φ71	2	65	57
φ125	120	2	M80	2	0	φ90	2	85	57

Use this type when the width across flats S of the A00 are required to be moved.

## A54

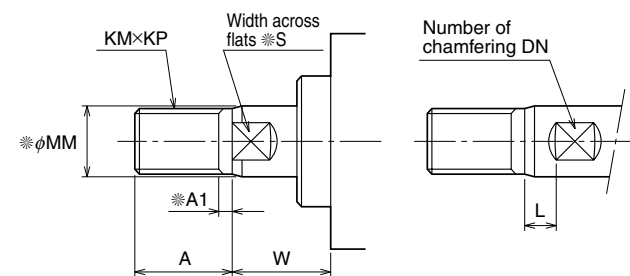

Basic dimensional table

Bore	A	φA1	DN	KM	KP	L	φMM	φS	W
φ40	35	4	2	M24	1.5	0	φ28	24	35
φ50	45	4	2	M30	1.5	0	φ35.5	30	41
φ63	60	4	2	M39	1.5	0	φ45	41	48
φ80	75	4	2	M48	1.5	0	φ56	50	51
φ100	95	5	2	M64	2	0	φ71	65	57
φ125	120	5	2	M80	2	0	φ90	85	57
φ140	140	5	Drill hole	M95	2	Drill hole	φ100	Drill hole	57
φ150	140	5	↑	M95	2	↑	φ100		57
φ160	150	5	↑	M100	2	↑	φ112		57

- Dimensions indicated by \* Mark are fixed as our semi-standard.
- You are requested to consult us if you would like to change fixed dimensions.

**A55**

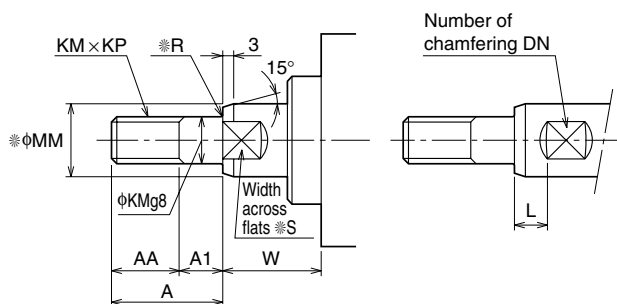

**Basic dimensional table**

Bore	A	AA	A1	DN	KM	KP	L	φMM	φR	φS	W
φ40	44	30	14	2	M20	1.5	0	φ28	1.6	24	35
φ50	49	35	14	2	M24	1.5	0	φ35.5	2	30	41
φ63	59	45	14	2	M30	1.5	0	φ45	2	41	48
φ80	74	60	14	2	M39	1.5	0	φ56	2	50	51
φ100	89	75	14	2	M48	1.5	0	φ71	2.5	65	57
φ125	115	95	20	2	M64	2	0	φ90	2.5	85	57

When modifying the dimension A1, specify the number of 10 or more.  
Specify the dimensions AA and A1 at the same time.

**A81**

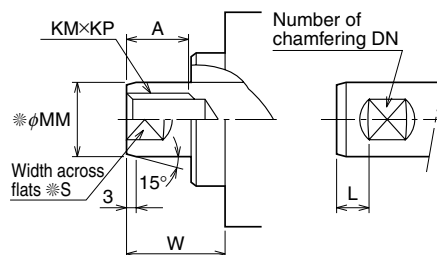

**Basic dimensional table**

Bore	A	DN	KM	KP	L	φMM	φS	W
φ40	24	2	M20	2.5	0	φ28	24	35
φ50	33	2	M27	3	0	φ35.5	30	41
φ63	36	2	M30	3.5	0	φ45	41	48
φ80	45	2	M39	4	0	φ56	50	51
φ100	58	2	M48	2	0	φ71	65	57

Note) • The possible number of chamfering DN is 2 (standard) or 4 only.

**A82**

※Exclusive M joint on the following pages

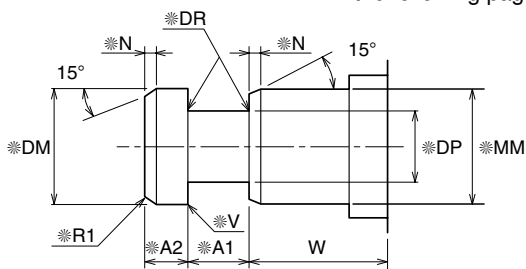

**Basic dimensional table**

Bore	A1 <sup>+0.5</sup> / <sub>+0.3</sub>	A2 <sup>-0.2</sup> / <sub>-0.3</sub>	DM	DP <sup>-0.2</sup> / <sub>-0.3</sub>	DR	MM	N	V	W
φ40	12.5	12.5	φ28	φ21	1.5	φ28	3	C0.2	35
φ50	15	15	φ35.5	φ26	2.0	φ35.5	3	C0.2	41
φ63	15	15	φ45	φ31	2.0	φ45	3	C0.2	48
φ80	20	20	φ56	φ38	3.0	φ56	3	C0.2	51
φ100	25	25	φ71	φ49	3.5	φ71	3	R1	57
φ125	30	30	φ90	φ60	5.0	φ90	6	R1	57

MM is rod dia.

• Dimensions indicated by ※ Mark are fixed as our semi-standard.  
• You are requested to consult us if you would like to change fixed dimensions.

Separate flange joint : Only for A82 rod end style

General purpose hydraulic cylinder

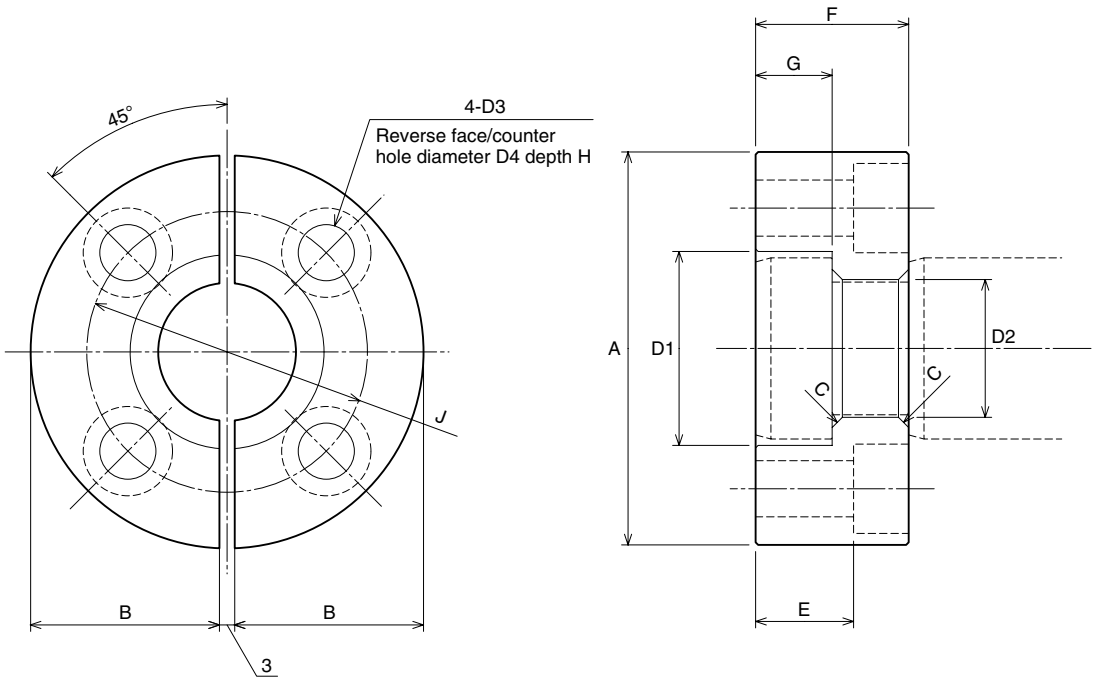

- Need additional order for this item. Part No. : RMH-(bore(mm))

**Dimensional table (rod B)**

Symbol Bore	Part code	A	B	C	D1	D2	D3	D4	E	F	G	H	J	X
φ32	RMH-18	φ49	23	1	φ19	φ13.5	φ6.6	φ11	18.5	25	12.5	6.5	φ34	–
φ40	RMH-22	φ57	27	1.5	φ23	φ16.5	φ9	φ14	16.4	25	12.5	8.6	φ40	–
φ50	RMH-28	φ71	34	1.5	φ29	φ21.5	φ11	φ17.5	14.2	25	12.5	10.8	φ50	–
φ63	RMH-36	φ77	37	2	φ38	φ27	φ11	φ17.5	19.2	30	15	10.8	φ55	–
φ80	RMH-45	φ100	48.5	2	φ48	φ33	φ14	φ20	17	30	15	13	φ76	16
φ100	RMH-56	φ124	60.5	3	φ60	φ41	φ18	φ26	22.5	40	20	17.5	φ92	7
φ125	RMH-70	φ150	73.5	3.5	φ74	φ53	φ22	φ32	28.5	50	25	21.5	φ112	14
φ140	RMH-80	φ174	85.5	4	φ84	φ60	φ26	φ39	24.5	50	25	25.5	φ129	40
φ150	RMH-85	φ180	88.5	5	φ90	φ62	φ26	φ39	34.5	60	30	25.5	φ135	26
φ160	RMH-90	φ193	95	5	φ95	φ64	φ30	φ43	31	60	30	29	φ144	9

Note) For LC mounting and B rod at A82 rod end, please add X dimension as minimum in order to avoid the interference.

**Dimensional table (rod A)**

Symbol Bore	Part code	A	B	C	D1	D2	D3	D4	E	F	G	H	J	Y
φ40	RMH-28	φ71	34	1.5	φ29	φ21.5	φ11	φ17.5	14.2	25	12.5	10.8	φ50	15
φ50	RMH-36	φ77	37	2	φ38	φ27	φ11	φ17.5	19.2	30	15	10.8	φ55	–
φ63	RMH-45	φ100	48.5	2	φ48	φ33	φ14	φ20	17	30	15	13	φ76	17
φ80	RMH-56	φ124	60.5	3	φ60	φ41	φ18	φ26	22.5	40	20	17.5	φ92	24
φ100	RMH-70	φ150	73.5	3.5	φ74	φ53	φ22	φ32	28.5	50	25	21.5	φ112	26
φ125	RMH-90	φ193	95	5	φ95	φ64	φ30	φ43	31	60	30	29	φ144	43

Note) For LB mounting and A rod at A82 rod end, please add Y dimension as minimum in order to avoid the interference.

## Setting method of switch detecting position

### AX type

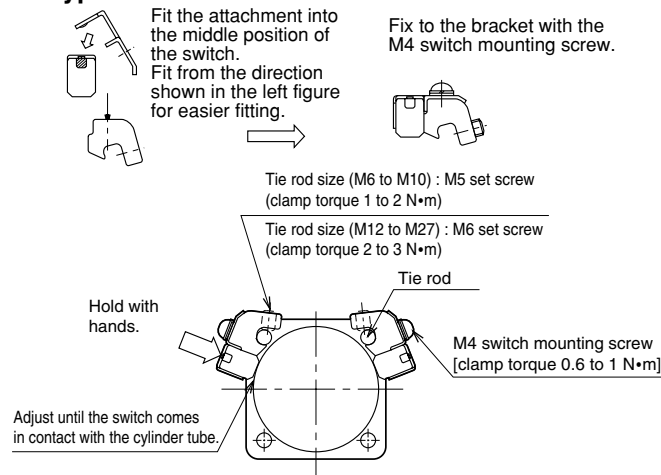

### WR type • WS type

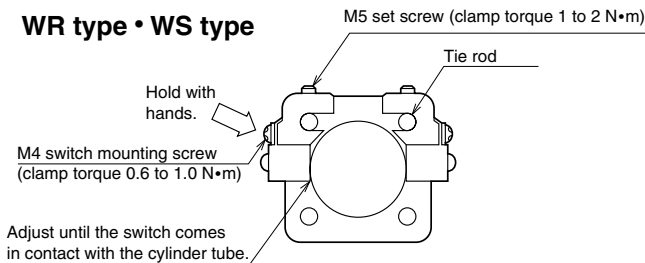

1. Loosen the two set screws with an allen wrench, and move them along with the tie rod.
2. Adjust the detecting position (for the 2-LED type, the position that the green lamp lights up) 2 to 5 mm (about half of the working range is appropriate) before the required position that the switch indicator lamp starts to light up (ON). Then, gently hold the top of the switch so that the cylinder tube contacts the detecting face of the switch, and clamp the set screw with the appropriate clamp torque.  
Note) Inappropriate clamp torque may cause the off-center of the switch position.
3. The indicator lamp lights up when the switch is set to the ON position.
4. Switches can be mounted to any of four tie rods and on the most suitable position depending on the mounting space of the cylinder and wiring method.
5. Mount a switch to the most suitable position to detect the stroke end with the "Switch mounting dimension" (dimension UX).

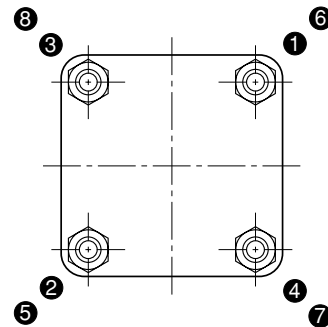

## Notes on assembly

### Clamping of tie rod

- When clamping the tie rods, DO NOT clamp only one tie rod at once, but clamp them gradually in the order shown in the right diagram. The single clamping of the tie rod may cause malfunctions or cracks of cylinders.

## Table of specified tie rod clamp torque

Bore mm		φ32	φ40	φ50	φ63	φ80	φ100	φ125
Tie rod screw		M10×1.25	M10×1.25	M10×1.25	M12×1.5	M16×1.5	M18×1.5	M22×1.5
Clamp torque N·m	70H-8	20	41	41	35	87	130	240
	140H-8				70	170	250	460

Bore mm		φ140	φ150	φ160	φ180	φ200	φ224	φ250
Tie rod screw		M24×1.5	M27×1.5	M27×1.5	M30×1.5	M33×1.5	M39×1.5	M42×1.5
Clamp torque N·m	70H-8	310	450	450	630	830	1400	1800
	140H-8	610	880	880	1100	1400	2400	3000



### Precautions for use

Take sufficient care to prevent the pressure in the cylinder with the rod A from exceeding the maximum allowable pressure, since the cylinder has the smaller pressurized area on the rod side, and the pressure in it tends to increase easily.

#### < Example >

Find the pressure on the rod side when the cylinder is moved forward (lowered) under the conditions shown below.

Cylinder : 140H-8  $\phi$ 80 Rod A  
 Load :  $W = 1000 \text{ kg} (\approx 10000 \text{ N})$   
 Set pressure :  $P_H = 8 \text{ MPa}$   
 Installing direction : Rod facing downward  
 Speed control : Meter-out

The working speed is slow, and the load rate is 100%.

#### < Answer >

The pressure  $P_R$ , generated on the rod side is the sum of the pressure  $P_1$ , generated to balance with the load  $W$  and the pressure  $P_2$ , boosted by the supply from the head side.

- The pressure  $P_1$ , generated to balance with the load  $W$ , can be calculated with the formula below.

$$P_1 = \frac{W}{A_R} = \frac{10000 \text{ (N)}}{2564 \text{ (mm}^2\text{)}} = 3.9 \text{ (MPa)}$$

- The pressure  $P_2$ , boosted by the supply from the head side, can be calculated with the formula below.  
 where,  $P_2 A_R = P_H A_H$

$$P_2 = \frac{P_H A_H}{A_R} = \frac{8 \text{ (MPa)} \times 5027 \text{ (mm}^2\text{)}}{2564 \text{ (mm}^2\text{)}} = 15.7 \text{ (MPa)}$$

- The pressure  $P_R$ , generated on the rod side, can be calculated with the formula below.

$$P_R = P_1 + P_2 = 3.9 + 15.7 = 19.6 \text{ (MPa)}$$

∴ Therefore, the pressure in the cylinder exceeds the maximum allowable pressure of the 140H-8, rod A type, on the rod side, 18 MPa shown in the standard specifications, and the cylinder is not applicable. Modify the working conditions, and re-calculate.

