

Position sensing cylinders using absolute type

- The position sensor applying a magnetostriction phenomenon enables high-accuracy absolute position detection.
- No sensor is needed for original position setting, and position correction is not required.
- Space-saving design and easy to install.
- Since cushions can be provided as standard, they can be used for general switching valves without any problem.
- They are applicable to wide variations of highly appreciated 70/140H-8 Series.



Standard Specifications

Type	General purpose type	
Nominal pressure	7 MPa	14 MPa
Maximum allowable pressure	9 MPa	18 MPa
Proof test pressure	21 MPa	
Minimum operating pressure	Cap side: 0.3 MPa or less Rod side: 0.45 MPa or less	
Working speed range	$\phi 50 \cdot \phi 63$: 8 to 400mm/s $\phi 80$ to 125 : 8 to 300mm/s $\phi 140$ to 250: 8 to 200mm/s	
Working temperature range (ambient temperature)	Standard type: -10 to $+80^{\circ}\text{C}$ Switch Set (AX/AZ type): -10 to $+70^{\circ}\text{C}$ Switch Set (WR/WS type): -10 to $+60^{\circ}\text{C}$ (No freezing)	
Structure of cushioning	Metal fitting system	
Adaptable fluid	Petroleum-based fluid (When using another fluid, refer to the table of fluid adaptability.)	
Tolerance for thread	JIS 6g/6H	
Tolerance of strokes	0 to 100mm $+0.8$ ₀ 101 to 250mm $+1.0$ ₀ 251 to 630mm $+1.25$ ₀ 631 to 1000mm $+1.4$ ₀ 1001 to 1600mm $+1.6$ ₀ 1601 to 2000mm $+1.8$ ₀	
Mounting style	SD · FA · FY · LA · LB · TA · TC	SD · FY · LA · TA · TC
Rod series	Rod B	
Accessories	Rod eye (T-end), rod clevis (Y-end) with pin, floating joint (F-end) (for 7 MPa), lock nut Boots : Nylon tarpaulin : Chloroprene : Conex	

Terminologies

Nominal pressure

Pressure given to a cylinder for convenience of naming. It is not always the same as the working pressure (rated pressure) that guarantees performance under the specified conditions.

Maximum allowable pressure

Maximum allowable pressure generated in a cylinder (surge pressure, etc.).

Proof test pressure

Test pressure against which a cylinder can withstand without unreliable performance at the return to nominal pressure.

Minimum operating pressure

Minimum pressure at which cylinder installed horizontally operates under no load.

- Notes
- The hydraulic pressure generated in a cylinder due to the inertia of load must be lower than the maximum allowable pressure.
 - The piston rod has a 13- to 16-mm dia. through hole. If the wall thickness is reduced or the wall is broken when a hex. screw is fitted, oil leakage can occur. Fit the screw carefully.
 - Do not loosen the plug at the rod end. Doing so may cause spout of oil.
 - The working temperature range depends on the seal material. For details, refer to the selection materials at the beginning of this catalog.
 - In the case that the lock nut is attached to the piston rod end thread part, increase the thread length (dimension A).
 - Conex, material of the boots, is the registered trademark of Teijin Limited.

Product Lineup

Unit: mm

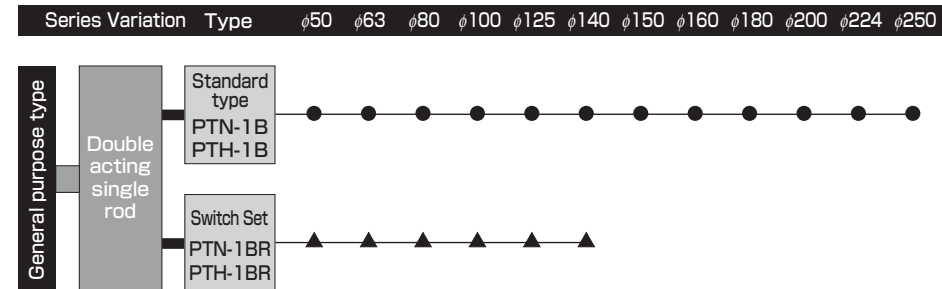

Note) ●-marked cylinders are the standard cylinders, and ▲-marked ones can be manufactured by design.

Detector Specifications

Power supply	24 V DC $\pm 2\text{V}$ 0.05A	
Accuracy	Linearity	$\pm 0.025\%$ FS or ± 75 μm TYP
	Resolution	$\pm 0.01\%$ FS or ± 30 μm or less
	Repeatability	$\pm 0.01\%$ FS or ± 30 μm or less
Temperature characteristics	Temperature	40 ppmFS/ or 12 $\mu\text{m}/$ or less
	Output	Current output: 4 to 20 mA Load resistance: 500 Ω or less For the voltage output (0 to 10 V, etc.), contact us.
Response speed	Scanning frequency 1 kHz	
Working temperature range	-20 to $+80^{\circ}\text{C}$ (No freezing)	
Impact resistance	50G 2m/s	
Vibration resistance	6 G or 40 Hz2mmPP	
Protective structure	IP67 (10 kPa, 30min)	
Connection	Pin No.	Signal
	1	24 V DC
	2	0V
	3	Output
Supplied connector	4	COM
	Shield to be connected to 0 V by user 0 V and COM are connected internally.	
Applicable cable (not supplied)	Outer diameter: $\phi 5$ to $\phi 6$ mm Wire size: 0.18 to 0.75 mm ²	

- Above shown are the specifications for the sensor only.
- A larger value of two values of each accuracy item is applicable.
- In the mounted state on the cylinder, the above accuracy cannot be assured due to deformation of cylinder elements caused by pressure and load.
For the repeatability under the same conditions, a value close to the above accuracy can be obtained because the deformation of cylinder elements is similar.
- The output is 4.0 to 4.5 mA at the cylinder retracting end and 12 to 20 mA at the cylinder advancing end. (In some cases, part of the effective length of the sensor is not used depending on the cylinder stroke.)
Set the controller parameters based on the actual output at the cylinder advancing and retracting ends.
- For sensors with adjustable output at the advancing and retracting ends, contact us.

Stroke Range

Unit: mm

Bore	Standard	Semi-standard
$\phi 50$	50 to 500	501 to 1200
$\phi 63 \cdot \phi 80$	50 to 500	501 to 1600
$\phi 100$	50 to 500	501 to 2000
$\phi 125$ to $\phi 160$	—	50 to 2000
$\phi 180$ to $\phi 250$	—	50 to 2000

- The above strokes indicate the maximum available strokes for the standard type. Contact us for other strokes.
- For the rod buckling, check with the buckling chart in the selection materials.

Cushion Stroke Length

Unit: mm

Type	Cushion ring length L	Cushion ring parallel part length l
Bore		
$\phi 50 \cdot \phi 63$	25	7
$\phi 80$ to $\phi 125$	25	8
$\phi 100$ to $\phi 160$	30	12
$\phi 180$ to $\phi 224$	40	20
$\phi 250$	45	25

- The cushion stroke lengths in case of cylinders used up to the stroke end.
- In the case that a cylinder is not used up to the stroke end, and it is stopped 5 mm or more before the stroke end, the cushioning effect will be weakened.
In such a case, consult us.

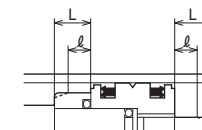

How to order

General Purpose Type

The item enclosed by broken line needs not to be entered, if unnecessary.

Semi-standard specification

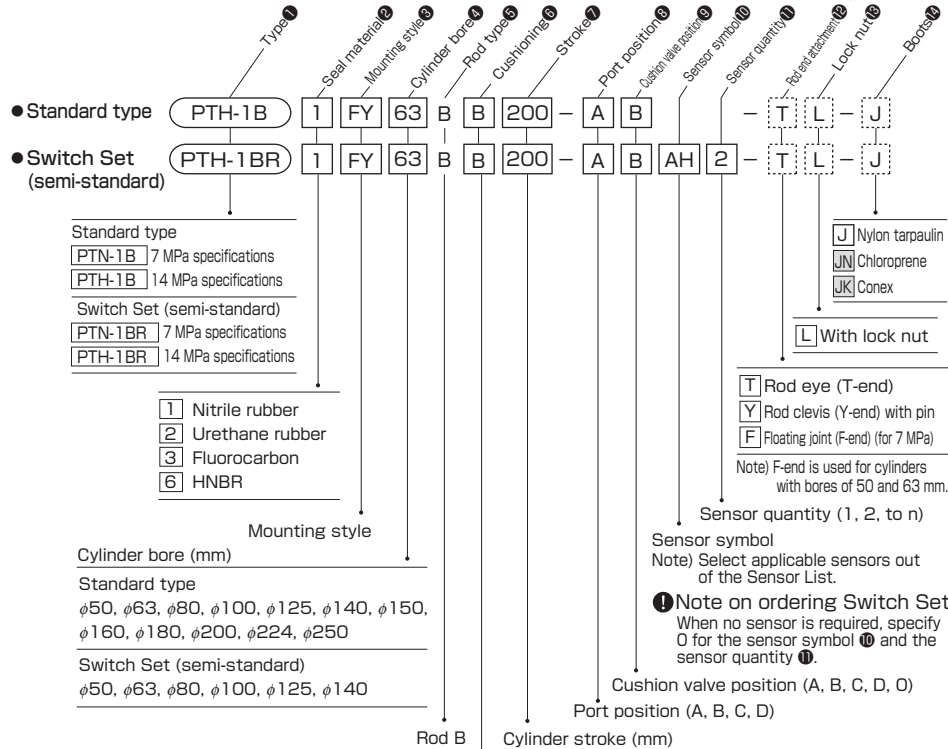

- Standard type: PTH-1B
- Switch Set (semi-standard): PTH-1BR

- Standard type: PTN-1B (7 MPa), PTH-1B (14 MPa)
- Switch Set (semi-standard): PTN-1BR (7 MPa), PTH-1BR (14 MPa)

- 1: Nitrile rubber
- 2: Urethane rubber
- 3: Fluorocarbon
- 6: HNBR

- J: Nylon tarpaulin
- UN: Chloroprene
- JK: Conex
- L: With lock nut

- T: Rod eye (T-end)
- Y: Rod clevis (Y-end) with pin
- F: Floating joint (F-end) (for 7 MPa)

Note on ordering Switch Set: When no sensor is required, specify 0 for the sensor symbol and the sensor quantity.

Semi-standard range

- With boots
- With sensor
- Changes to detector specifications: Inverted output (20 to 4 mA), voltage output (0 to 10 V), digital output, etc.
- Change of piston rod end (dimensional symbol: W, A, KK)
- Other material
- Change of TC accessory position (dimensional symbol: PH)
- Plated cylinder tube (hard chrome plating thickness: 0.02 mm)

- B: With cushions on both ends
- R: With cushion on rod side
- H: With cushion on cap side
- N: No cushion

Mounting Style

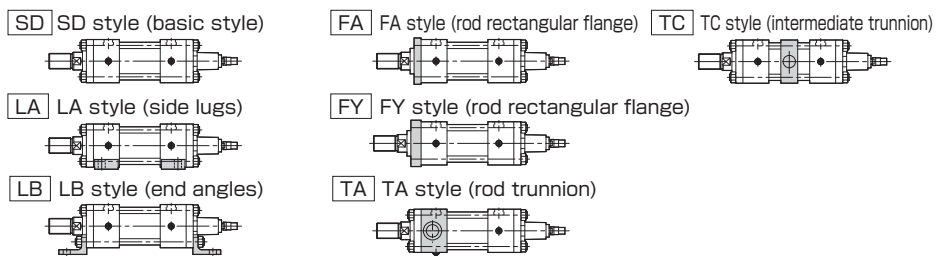

Sensor List

Semi-standard

Type	Sensor symbol	Load voltage range	Load current range	Max. switching capacity	Protective circuit	Indicating lamp	Wiring method	Cord length	Applicable load				
Reed sensor	AF AX101CE	DC: 5 to 30V AC: 5 to 120V	DC: 5 to 40mA AC: 5 to 20mA	DC: 1.5W AC: 2VA	None	LED (Lights in red when sensing)	0.3 mm ² , 2-core, outer dia. φ4 mm, rear wiring	1.5m	Small relay, programmable controller				
	AG AX105CE				5m								
	AH AX111CE				1.5m								
	AJ AX115CE				5m								
	AE AX125CE	DC: 30 V or less AC: 120 V or less	DC: 40 mA or less AC: 20 mA or less	2VA	None	None	5m						
	AK AX11ACE	AC: 5 to 120V	5 to 20mA		Provided	LED (Lights in red when sensing)	4-pin connector type, rear wiring	0.5m					
	AL AX11BCE	DC: 5 to 30V	5 to 40mA	1.5W	Provided	LED (Lights in red when not sensing)	0.3 mm ² , 2-core, outer dia. φ4 mm, rear wiring	5m					
	AM AX135CE	AC/DC: 90 to 240V	5 to 300mA	B contact output				5m					
	AY AZ135CE							5m					
	Solid state sensor	S SR405	AC: 80 to 220V	2 to 300mA	30VA	Provided	Neon lamp (Lights when not sensing)	0.5 mm ² , 2-core, outer dia. φ6 mm, rear wiring		5m			
5 WR505		DC: 5 to 50V AC: 5 to 120V	DC: 3 to 40mA AC: 3 to 20mA	DC: 1.5W AC: 2VA	None	LED (Lights in red when sensing)	0.3 mm ² , 2-core, outer dia. φ4 mm, rear wiring	5m					
7 WR505F								5m					
6 WR515								5m					
Cutting oil proof type		BE AX201CE-1	DC: 5 to 30V	5 to 40mA	—	Provided	LED (Lights in red when sensing)	0.3 mm ² , 2-core, outer dia. φ4 mm, rear wiring	1.5m				
		BF AX205CE-1							5m				
	CE AX211CE-1	1.5m											
	CF AX215CE-1	5m											
Solid state sensor	RA AX205WCE	DC: 5 to 30V	5 to 40mA	—	Provided	LED (Lights in red when sensing)	0.3 mm ² , 2-core, outer dia. φ4 mm, rear wiring	5m					
	RB AZ205WCE							5m					
	RE AX215WCE		5 to 20mA					DC: 10 to 30V	5 to 20mA	—	LED (2-LED type in red/green)	0.3 mm ² , 2-core, outer dia. φ4 mm, rear wiring	5m
	RF AZ215WCE												5m
2 WS215-1	DC: 5 to 30V	5 to 40mA	—	Provided	LED (2-LED type in red/green)	0.3 mm ² , 2-core, outer dia. φ4 mm, rear wiring	5m						
4 WS215-1F							5m						
3 WS225-1							5m						
Cutting oil proof type	CT AX211CE-1	DC: 5 to 30V	5 to 40mA	—	Provided	LED (2-LED type in red/green)	0.3 mm ² , 2-core, outer dia. φ4 mm, rear wiring	1.5m					
	CU AX215CE-1							5m					
	CV AX21BCE-1							0.5m					
	CW AZ211CE-1							1.5m					
	CX AZ215CE-1							5m					
	CY AZ21BCE-1							0.5m					

Notes: For the sensors without a protective circuit, be sure to provide a protective circuit (SK-100) with the load when using any induction load (relay, etc.). The output logic of AX and AZ135CE is B contact. When the piston is detected, the sensor contact turns off (the lamp turns on). For the details of sensors, be sure to read the sensor specifications at the end of this catalog. All AX type sensors can be mounted. For types other than the above, refer to the sensor specifications at the end of this catalog. WR/WS, AX*W and AZ*W type sensors are cutting oil proof. Sensor SR405 can be mounted only to cylinders with bores from 32 to 125 mm.

General purpose type AX type sensor

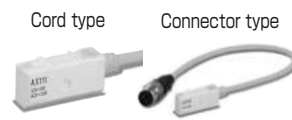

Cutting oil proof type WR/WS type sensors



- When ordering the cutting oil proof type sensors, WR and WS types, please be careful about the following points.
- 5 WR505: The sensor and straight box connector (F-SB) are combined (the flexible tube (F-0.5: 4.8 m) is required).
- 7 WR505F: The flexible tube (F-0.5: 4.8 m) is attached to the sensor and straight box connector (F-SB).
- 4 WS215-1F

Discontinued

PQCPA Series dedicated to analog/pulse output position sensing cylinders

- Environmentally-friendly lead-free indicator.
- Analog input and pulse input types are available.
- Provided with multi-point output function (5 points) as a standard function to enable to individually set the upper and lower limits.^{Note 1)}
- A 16-bit AD converter is provided to realize high resolution. (Analog input type)
- Provided with a counter with a response frequency of 200 kHz (Pulse input type)
- Provided with a pulse position correcting function.^{Note 2)}

Note 1) Setting the bank switching enables to use the multi-output function of up to 15 points.
 Note 2) Position correction can be made by mounting a cylinder sensor. Positional error caused by slippage of the encoder is eliminated.



Standard Specifications

Type	Analog	Pulse
Model number	PQCPA-CU-A	PQCPA-CU-P
Applicable input signals	Analog voltage/analog current	Phase AB
Display range	±999999	
Resolution	Stroke×1/10000	—
Response frequency	1 kHz	200 kHz
Linearity	±0.02%FS	—
Signals	Voltage input 0 to 10 V Voltage input 1 to 5 V Current input 4 to 20 mA	Open collector input Differential input (line driver input) 12 V voltage input 24 V voltage input
Monitor output	Voltage output (Note)	Line driver output
Sampling speed	1000 times/sec	
Display speed	10 times/sec	
Display method	Display by fluorescent display tube	
Control input	No-voltage input (reed sensor/solid state sensor)	
Control output	Open collector Max. rating: 50 V DC, 50 mA (Provided with multi-point output function (5 points) to enable to individually set the upper and lower limits and pulse position correcting function)	
Power supply voltage	24 V DC ±10%	
Ambient temperature	0 to 50°C (No freezing)	
Ambient humidity	35 to 85%RH (No condensing)	

Note) The monitor output at current input (4 to 20 mA) is voltage output of 1 to 5 V.

Function Table

Type	Analog input	Pulse input
Model number	PQCPA-CU-A-A	PQCPA-CU-P-12
	PQCPA-CU-A-V	PQCPA-CU-P-24
Functions	—	PQCPA-CU-P-00
	Display of position	Display of position
	Bank switching	Bank switching
	Multi-point output	Multi-point output
	Positional data hold	Positional data hold
	—	0 setting signal
—	Correcting function	

List of Applicable Actuators

Series	Detection method	Signal type
PTN-1B	Absolute type	Analog type (4 to 20 mA, 0 to 10 V)
PTH-1B		
PTT-1B		Analog type (1 to 5 V)
PSR-1A		
35P-3	Linear pulse encoder	Encoder type
70P-8		
140P-8		

Note) For the details of each cylinder, refer to the section of each series.

● How to order **Discontinued**

Position Indicator

● Analog input

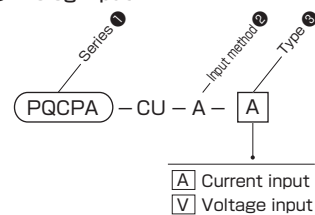

● Pulse input

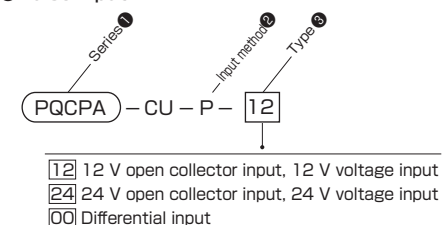

Note) Cylinders do not come with indicators of differential input type [00].
(Specification to use the indicator in stand-alone state)

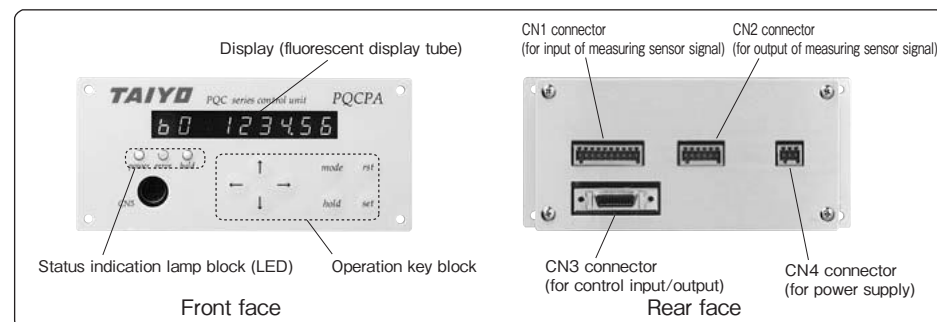

Dimensional Drawings

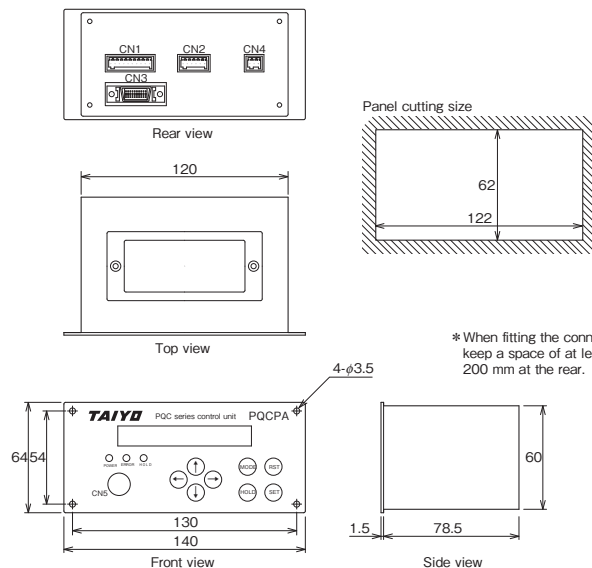

Supplied Connector

- CN1 connector (for input of measuring sensor signal)
- CN2 connector (for output of measuring sensor signal)
- CN3 connector (for control input/output)
- CN4 connector (for power supply)

* When fitting the connectors, keep a space of at least 200 mm at the rear.

Discontinued

How to order cable between sensor and indicator

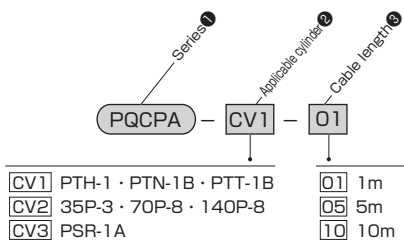

* When ordering a cable, confirm the series name of the actuator on the sensor side.
Some models cannot be connected.

* After wiring, connect the indicator side connector to the CN1 connector on the indicator.

PQCPA-CV1-Cable length

Applicable actuators: PTH-1B/PTN-1B/PTT-1B

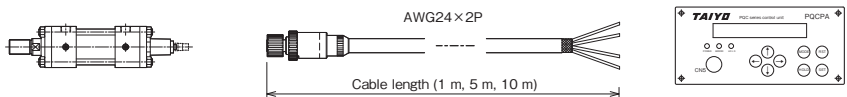
**PQCPA-CV2-Cable length**

Applicable actuators: 35P-3/70P-8/140P-8

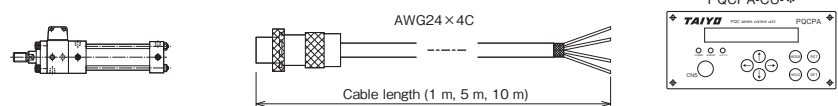
**PQCPA-CV3-Cable length**

Applicable actuators: PSR-1A

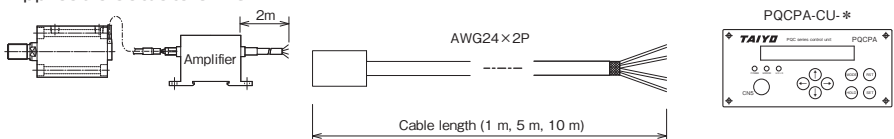

Note) PSR-1A comes with a 2m cable as a standard accessory. If another cable is required, select this cable. (In this case, disconnect the standard cable (2 m) of PSR-1A, and connect the selected cable directly to the amplifier.)

How to order I/O cable

PQCPA — IO

*The I/O cable is 5 m long.

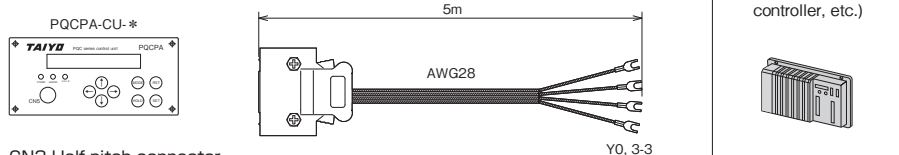

CN3 Half-pitch connector

Note) Only the CN3 half-pitch connector is supplied as a standard accessory.
If you need the connector with a cable, place an order for the connector.

Discontinued

External input/output

CN1

Pin No.	Description	Signals
1	Voltage/current input	Analog input
2	NC	-
3	Voltage/current GND	Analog input
4	Phase A	Pulse input
5	Phase -A	Pulse input
6	Phase B	Pulse input
7	Phase -B	Pulse input
8	+24V	Power supply output
9	+12V	Power supply output
10	GND	Power supply output/Phase AB GND

CN2

Pin No.	Description	Signals
1	Pout	Analog output
2	Vss	Analog output
3	A pulse	Pulse output
4	A pulse GND	Pulse output
5	B pulse	Pulse output
6	B pulse GND	Pulse output

CN4

Pin No.	Description	Signals
1	P24	Power supply
2	N24	Power supply
3	PE	Power supply

CN3

Pin No.	Description	Signals
1	0 setting signal	Input
2	Positional data hold	Input
3	Correcting function	Input
4	Bank switching 0	Input
5	Bank switching 1	Input
6	Bank switching 2	Input
7	Reserved input	Input
8	Reserved input	Input
9	Input common	Input
10	Input common	Input
11	Multi-point output signal 0	Output
12	Multi-point output signal 1	Output
13	Multi-point output signal 2	Output
14	Multi-point output signal 3	Output
15	Multi-point output signal 4	Output
16	Reserved output	Output
17	Reserved output	Output
18	Reserved output	Output
19	Output common	Output
20	Output common	Output

* For details, see the instruction manual.

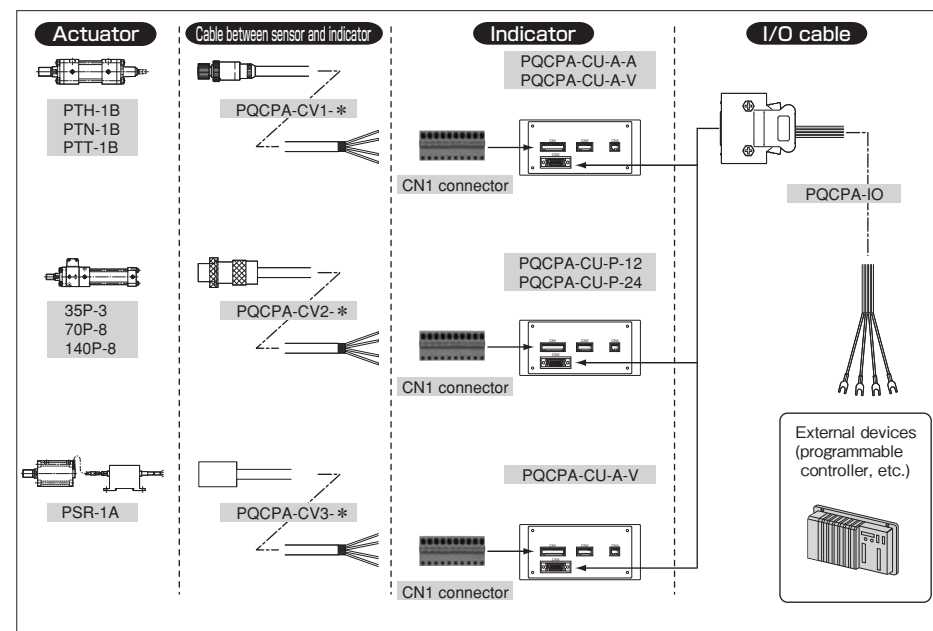
Example of product configuration

Weight table

Unit: kg

Bore mm	Basic weight (SD style)	Additional weight per mm of stroke	Mounting accessory weight							Rod end attachment weight			
			LA	LB	FA	FY	TA	TC	Rod eye (T-end)	Rod clevis (Y-end) with pin	Floating joint (F-end)	Lock nut	
φ50	5.9	0.014	0.9	—	0.7	1.1	0.4	1.0	1.0	1.2	1.4	0.1	
φ63	9.4	0.017	1.0	1.2	1.0	1.6	0.6	1.2	2.7	3.9	2.7	0.1	
φ80	18.9	0.032	1.8	2.0	1.1	2.1	0.6	2.1	2.2	3.7	—	0.2	
φ100	30.5	0.048	2.1	2.9	1.8	3.9	1.0	3.8	4.2	7.7	—	0.5	
φ125	43.5	0.077	3.2	5.5	2.9	6.2	2.1	6.2	8.0	14.6	—	1.1	
φ140	60.2	0.100	3.8	7.7	3.2	8.2	4.1	11.1	19.0	28.8	—	1.4	
φ150	69.6	0.118	4.8	9.6	4.9	10.7	4.6	10.9	18.9	28.3	—	1.7	
φ160	84.3	0.121	5.4	10.0	5.3	11.3	5.2	14.8	22.7	34.2	—	1.9	
φ180	115.1	0.179	7.9	13.8	7.7	17.5	—	19.4	37.6	53.7	—	2.9	
φ200	155.2	0.220	11.4	21.0	10.6	22.6	—	27.2	53.9	87.4	—	3.2	
φ224	203.8	0.268	12.7	32.0	11.6	30.6	—	36.5	77.2	128.3	—	6.0	
φ250	283.7	0.333	18.3	46.7	17.5	42.5	—	43.3	74.4	123.9	—	7.8	

Sensor Additional Weight

Unit: kg

Bore (mm)	Symbol	AX type			SR type	WR/WS type
		Cord length 1.5 m	Cord length 5 m	Connector type	Cord length 5 m	
φ50		0.05	0.13	0.04	0.22	0.5
φ63		0.07	0.14	0.06	0.22	
φ80·φ100		0.07	0.15	0.06	0.22	
φ125		0.09	0.16	0.07	0.22	
φ140		0.09	0.16	0.08	—	

Calculation formula Cylinder weight (kg)=basic weight+(cylinder stroke (mm)×additional weight per mm of stroke)+(sensor additional weight×sensor quantity)+mounting accessory weight+rod end attachment weight

Calculation example PTH-1BR, bore φ80, cylinder stroke 200 mm, 2 pcs of AX101 (cord length 1.5 m), LA style
 $18.9+(0.032\times 200)+(0.05\times 2)+1.8=27.2\text{kg}$

Sectional Drawing

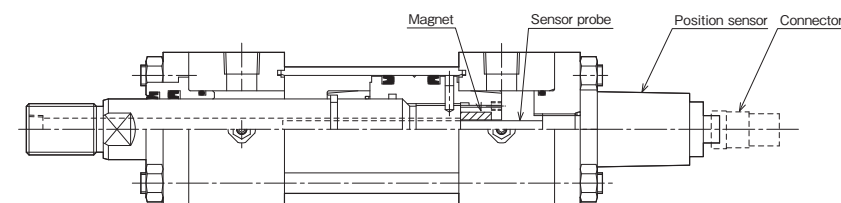

Note) The structure differs slightly depending on the cylinder bore and the position sensor type.

Application Example

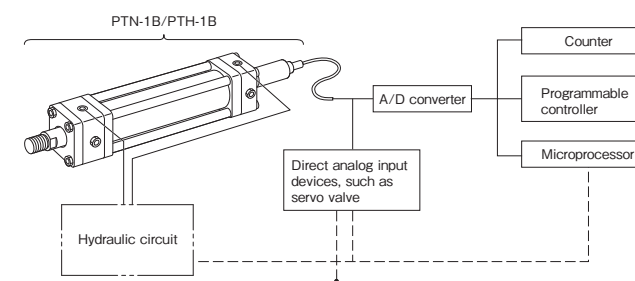

◎The cylinder position and operation can be checked on the counter, and position adjustment and inching can be easily performed by manual operation.

◎When combined with a personal computer or a microprocessor, the cylinder can be decelerated and stopped at any position.

Principle of Operation of Position Sensor

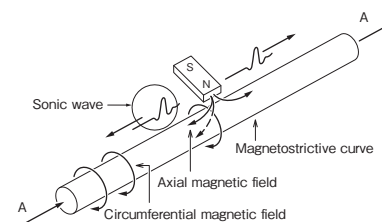

The figure shows the basic principle. When a current pulse shown by arrow A is given to the magnetostrictive curve, a circumferential magnetic field is generated on the magnetostrictive curve. When a magnet is positioned as shown in the figure, an axial magnetic field is given only to the position, and a diagonal magnetic field as shown by the dotted line is generated, thereby causing torsion in this part of the magnetostrictive curve. Since this torsion is a kind of vibration, it propagates at the sonic speed on the magnetostrictive curve which is a metallic tube. PTN-1B and PTH-1B Series use absolute type position sensors which measure the propagation time at the supersonic speed to find the magnet position.

PTN_PTH-1B/THPT1B Bore B is available.

SD

PTN-1B	1	SD	Bore	B	B	Stroke	-	A	B
PTH-1B	1	SD	Bore	B	B	Stroke	-	A	B

● Bore φ50 to φ250

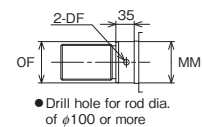

Rod dia.	OF	DF
φ100	φ99.5	φ12
φ112	φ111.5	φ15
φ125	φ124.5	φ15
φ140	φ139.5	φ15

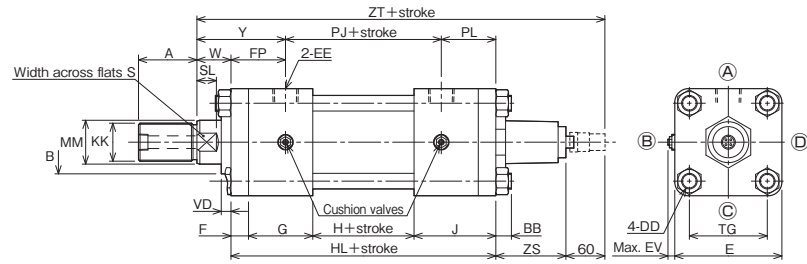

● The above figure shows a cylinder with bores from 63 to 100 mm. The shape of the sensor area differs depending on the bore.

- When using the SD style, refer to the "Precautions for Use" at the beginning of this catalog.
- For the thread length (dimension A) in case of using the lock nut, refer to "Accessories".
- Some piston rods have a through hole for fitting a sensor (φ13 to φ16). If a hole is made, the thickness may be excessively reduced. It is recommended to use a lock nut to lock the rod end attachment. When drilling is performed to use a hex. screw, the drilling depth must be 2 mm or less. Do not use a spring pin.
- Switch Set Cylinders (φ50 to φ140) are manufactured as semi-standard models. For the mounting of sensors, refer to the dimensional drawings of "Switch Set".
- The shape of the sensor fitting area differs depending on the cylinder bore.

With Boots

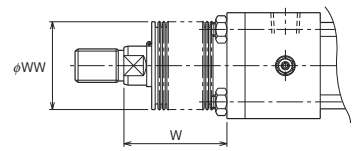

	Standard	Semi-standard	
Material	Nylon tarpaulin	Chloroprene	Conex
Heat proof	80°C	130°C	200°C

Notes ● Remember that the heat proof field in the table above shows the allowable temperatures for the boots, not for the cylinder.

- Conex is the registered trademark of Teijin Limited.
- The boots have been mounted at our factory prior to delivery.

Dimension W		
Nylon tarpaulin	φ50	1/3.5 stroke+X
Chloroprene	φ63 to φ100	1/4 stroke+X
	φ125 to φ200	1/5 stroke+X
	φ224 to φ250	1/6 stroke+X
Conex	φ50	1/2.5 stroke+X
	φ63 to φ100	1/3 stroke+X
	φ125-φ140	1/3.5 stroke+X
	φ150 to φ200	1/4 stroke+X
	φ224-φ250	1/4.5 stroke+X

● If the calculated value has a fractional part, round it up.

Dimensional Table

Symbol Bore	Rod B						
	A	B	KK	MM	S	SL	VD
φ50	35	φ46	M24×1.5	φ28	24	14	10
φ63	45	φ55	M30×1.5	φ35.5	30	16	10
φ80	60	φ65	M39×1.5	φ45	41	20	10
φ100	75	φ80	M48×1.5	φ56	50	23	10
φ125	95	φ95	M64×2	φ71	65	27	10
φ140	110	φ105	M72×2	φ80	75	31	10
φ150	115	φ110	M76×2	φ85	80	33	10
φ160	120	φ115	M80×2	φ90	85	33	10
φ180	140	φ125	M95×2	φ100	-	-	10
φ200	150	φ140	M100×2	φ112	-	-	10
φ224	180	φ150	M120×2	φ125	-	-	10
φ250	195	φ170	M130×2	φ140	-	-	10

Symbol Bore	BB	DD	E	EE	EV	F	FP	G	H	HL	J	PJ	PL	TG	W	Y	ZS	ZT
φ50	11	M10×1.25	□76	Rc1/2	7	13	42	54	48	182	67	98	42	□52	30	72	83	355
φ63	13	M12×1.5	□90	Rc1/2	7	15	46	56	52	194	71	102	46	□63	35	81	72	361
φ80	16	M16×1.5	□110	Rc3/4	7	18	56	66	54	222	84	110	56	□80	35	91	72	389
φ100	18	M18×1.5	□135	Rc3/4	7	20	58	66	60	232	86	116	58	□102	40	98	72	404
φ125	21	M22×1.5	□165	Rc1	11	24	67	76	64	220	56	130	23	□122	45	112	90	415
φ140	22	M24×1.5	□185	Rc1	11	26	69	76	72	230	56	138	23	□138	50	119	90	430
φ150	25	M27×1.5	□196	Rc1	11	28	71	76	80	240	56	146	23	□148	50	121	72	422
φ160	25	M27×1.5	□210	Rc1	13	31	74	81	80	253	61	156	23	□160	55	129	72	440
φ180	27	M30×1.5	□235	Rc1 1/4	13	33	75	85	86	275	71	172	28	□182	55	130	72	462
φ200	29	M33×1.5	□262	Rc1 1/2	13	37	85	95	90	301	79	184	32	□200	55	140	72	488
φ224	34	M39×1.5	□292	Rc1 1/2	13	41	89	95	90	305	79	184	32	□225	60	149	72	497
φ250	37	M42×1.5	□325	Rc2	13	46	106	115	90	346	95	200	40	□250	65	171	72	543

● The tolerance of B is h8, and that of MM is f8.

Outline Drawings of Sensor Area

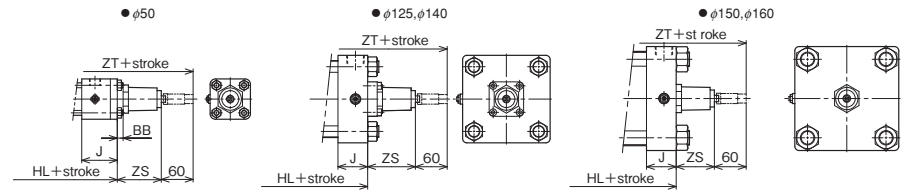

With Boots

Bore	φ50	φ63	φ80	φ100	φ125	φ140	φ150	φ160	φ180	φ200	φ224	φ250
WW	63	71	80	100	125	125	140	140	160	180	180	200
X	45	55	55	55	65	65	65	65	65	65	80	80

PTN_PTH-1B/THPT1B Bore B is available.

LA

PTN-1B	1	LA	Bore	B	Stroke	-	A	B
PTH-1B	1	LA	Bore	B	Stroke	-	A	B

● Bore φ50 to φ250

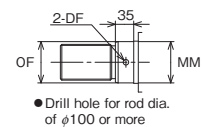

Rod dia.	OF	DF
φ100	φ99.5	φ12
φ112	φ111.5	φ15
φ125	φ124.5	φ15
φ140	φ139.5	φ15

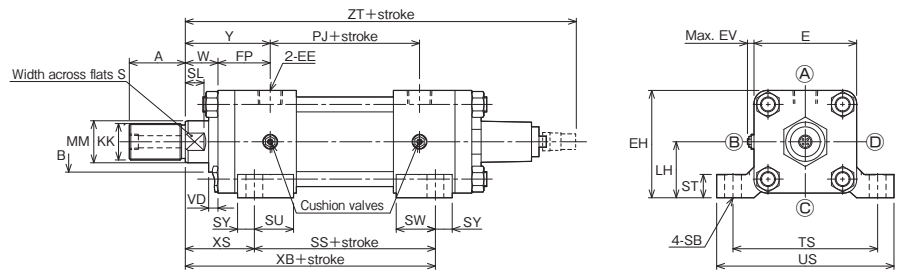

● The above figure shows a cylinder with bores from 63 to 100 mm. The shape of the sensor area differs depending on the bore.

- For the thread length (dimension A) in case of using the lock nut, refer to "Accessories".
- Some piston rods have a through hole for fitting a sensor (φ13 to φ16). If a hole is made, the thickness may be excessively reduced. It is recommended to use a lock nut to lock the rod end attachment. When drilling is performed to use a hex. screw, the drilling depth must be 2 mm or less. Do not use a spring pin.
- Switch Set Cylinders (φ50 to φ140) are manufactured as semi-standard models.
- For the mounting of sensors, refer to the dimensional drawings of "Switch Set".
- The shape of the sensor fitting area differs depending on the cylinder bore.

With Boots

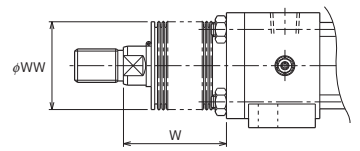

	Standard	Semi-standard	
Material	Nylon tarpaulin	Chloroprene	Conex
Heat proof	80°C	130°C	200°C

(Notes) ● Remember that the heat proof field in the table above shows the allowable temperatures for the boots, not for the cylinder.
 ● Conex is the registered trademark of Teijin Limited.
 ● The boots have been mounted at our factory prior to delivery.

Dimension W		
Nylon tarpaulin	φ50	1/3.5 stroke+X
Chloroprene	φ63 to φ100	1/4 stroke+X
	φ125 to φ200	1/5 stroke+X
	φ224 to φ250	1/6 stroke+X
Conex	φ50	1/2.5 stroke+X
	φ63 to φ100	1/3 stroke+X
	φ125-φ140	1/3.5 stroke+X
	φ150 to φ200	1/4 stroke+X
	φ224-φ250	1/4.5 stroke+X

● If the calculated value has a fractional part, round it up.

Dimensional Table

Symbol	Rod B						
	A	B	KK	MM	S	SL	VD
φ50	35	φ46	M24×1.5	φ28	24	14	10
φ63	45	φ55	M30×1.5	φ35.5	30	16	10
φ80	60	φ65	M39×1.5	φ45	41	20	10
φ100	75	φ80	M48×1.5	φ56	50	23	10
φ125	95	φ95	M64×2	φ71	65	27	10
φ140	110	φ105	M72×2	φ80	75	31	10
φ150	115	φ110	M76×2	φ85	80	33	10
φ160	120	φ115	M80×2	φ90	85	33	10
φ180	140	φ125	M95×2	φ100	-	-	10
φ200	150	φ140	M100×2	φ112	-	-	10
φ224	180	φ150	M120×2	φ125	-	-	10
φ250	195	φ170	M130×2	φ140	-	-	10

Symbol	E	EE	EH	EV	FP	LH	PJ	SB	SS	ST	SU	SW	SY	TS	US	W	XB	XS	Y	ZT
φ50	□76	Rc1/2	83	7	42	45±0.15	98	φ14	122	17	34	34	14	115	145	30	182	60	72	355
φ63	□90	Rc1/2	95	7	46	50±0.15	102	φ18	122	19	32	32	18	132	165	35	193	71	81	361
φ80	□110	Rc3/4	115	7	56	60±0.25	110	φ18	144	25	42	42	18	155	190	35	218	74	91	389
φ100	□135	Rc3/4	138.5	7	58	71±0.25	116	φ22	142	27	38	38	22	190	230	40	227	85	98	404
φ125	□165	Rc1	167.5	11	67	85±0.25	130	φ26	136	32	41	41	25	224	272	45	235	99	112	415
φ140	□185	Rc1	187.5	11	69	95±0.25	138	φ26	144	35	41	41	25	250	300	50	250	106	119	430
φ150	□196	Rc1	204	11	71	106±0.25	146	φ30	146	37	38	38	28	270	320	50	257	111	121	422
φ160	□210	Rc1	217	13	74	112±0.25	156	φ33	150	42	40	40	31	285	345	55	272	122	129	440
φ180	□235	Rc1 1/4	242.5	13	75	125±0.25	172	φ33	172	47	50	36	35	315	375	55	295	123	130	462
φ200	□262	Rc1 1/2	271	13	85	140±0.25	184	φ36	186	52	56	40	39	355	425	55	317	131	140	488
φ224	□292	Rc1 1/2	296	13	89	150±0.25	184	φ42	186	52	56	40	39	395	475	60	326	140	149	497
φ250	□325	Rc2	332.5	13	106	170±0.25	200	φ45	206	57	68	48	47	425	515	65	364	158	171	543

● The tolerance of B is h8, and that of MM is f8.

Outline Drawings of Sensor Area

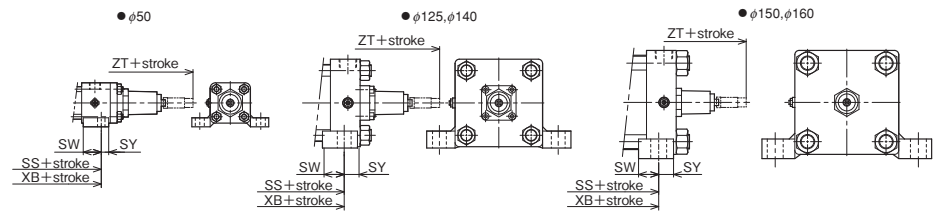

With Boots

Bore	φ50	φ63	φ80	φ100	φ125	φ140	φ150	φ160	φ180	φ200	φ224	φ250
WW	63	71	80	100	125	125	140	140	160	180	180	200
X	45	55	55	55	65	65	65	65	65	65	80	80

PTN_PTH-1B/THPT1B Bore B is available.

LB For 7 MPa

PTN-1B 1 LB Bore B B Stroke - A B

- Bore $\phi 63$ to $\phi 250$

LB accessory working face ($\phi 50$ to $\phi 80$)

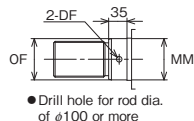
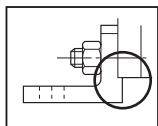

● Drill hole for rod dia. of $\phi 100$ or more

Rod dia.	OF	DF
$\phi 100$	$\phi 99.5$	$\phi 12$
$\phi 112$	$\phi 111.5$	$\phi 15$
$\phi 125$	$\phi 124.5$	$\phi 15$
$\phi 140$	$\phi 139.5$	$\phi 15$

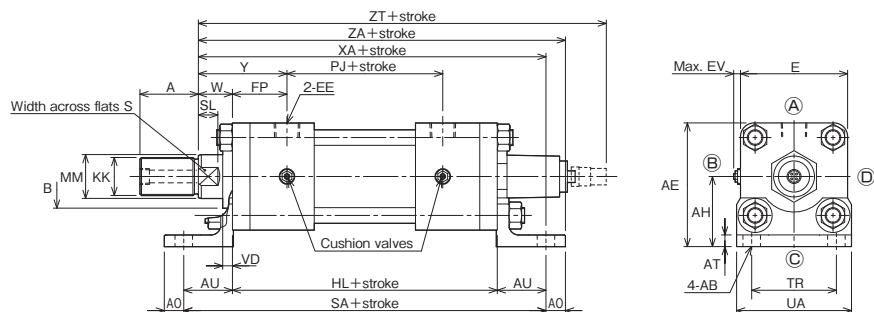

- The above figure shows a cylinder with bores from 63 to 100 mm. The shape of the sensor area differs depending on the bore.

- For the thread length (dimension A) in case of using the lock nut, refer to "Accessories".
- Some piston rods have a through hole for fitting a sensor ($\phi 13$ to $\phi 16$). If a hole is made, the thickness may be excessively reduced. It is recommended to use a lock nut to lock the rod end attachment. When drilling is performed to use a hex. screw, the drilling depth must be 2 mm or less. Do not use a spring pin.
- Switch Set Cylinders ($\phi 63$ to $\phi 140$) are manufactured as semi-standard models.
- For the mounting of sensors, refer to the dimensional drawings of "Switch Set".
- The shape of the sensor fitting area differs depending on the cylinder bore.

With Boots

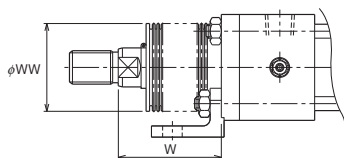

Dimension W

Nylon tarpaulin	$\phi 63$ to $\phi 100$	1/4	stroke+X
Chloroprene	$\phi 125$ to $\phi 200$	1/5	stroke+X
	$\phi 224$ to $\phi 250$	1/6	stroke+X
Conex	$\phi 63$ to $\phi 100$	1/3	stroke+X
	$\phi 125$ - $\phi 140$	1/3.5	stroke+X
	$\phi 150$ to $\phi 200$	1/4	stroke+X
	$\phi 224$ - $\phi 250$	1/4.5	stroke+X

	Standard	Semi-standard	
Material	Nylon tarpaulin	Chloroprene	Conex
Heat proof	80°C	130°C	200°C

- (Notes) ● Remember that the heat proof field in the table above shows the allowable temperatures for the boots, not for the cylinder.
- Conex is the registered trademark of Teijin Limited.
 - The boots have been mounted at our factory prior to delivery.

- If the calculated value has a fractional part, round it up.

Dimensional Table

Symbol Bore	Rod B						
	A	B	KK	MM	S	SL	VD
$\phi 63$	45	$\phi 55$	M30×1.5	$\phi 35.5$	30	16	10
$\phi 80$	60	$\phi 65$	M39×1.5	$\phi 45$	41	20	10
$\phi 100$	75	$\phi 80$	M48×1.5	$\phi 56$	50	23	10
$\phi 125$	95	$\phi 95$	M64×2	$\phi 71$	65	27	10
$\phi 140$	110	$\phi 105$	M72×2	$\phi 80$	75	31	10
$\phi 150$	115	$\phi 110$	M76×2	$\phi 85$	80	33	10
$\phi 160$	120	$\phi 115$	M80×2	$\phi 90$	85	33	10
$\phi 180$	140	$\phi 125$	M95×2	$\phi 100$	—	—	10
$\phi 200$	150	$\phi 140$	M100×2	$\phi 112$	—	—	10
$\phi 224$	180	$\phi 150$	M120×2	$\phi 125$	—	—	10
$\phi 250$	195	$\phi 170$	M130×2	$\phi 140$	—	—	10

Symbol Bore	AB	AE	AH	AO	AT	AU	E	EE	EV	FP	HL	PJ	SA	TR	UA	W	XA	Y	ZA	ZT
	$\phi 63$	$\phi 18$	105	60 ± 0.15	18	10	42	$\square 90$	Rc1/2	7	46	194	102	278	65	98	35	271	81	289
$\phi 80$	$\phi 18$	127	72 ± 0.25	20	12	50	$\square 110$	Rc3/4	7	56	222	110	322	87	118	35	307	91	327	389
$\phi 100$	$\phi 22$	152.5	85 ± 0.25	23	12	55	$\square 135$	Rc3/4	7	58	232	116	342	109	150	40	327	98	350	404
$\phi 125$	$\phi 26$	187.5	105 ± 0.25	29	15	66	$\square 165$	Rc1	11	67	220	130	352	130	175	45	331	112	360	415
$\phi 140$	$\phi 26$	207.5	115 ± 0.25	30	18	70	$\square 185$	Rc1	11	69	230	138	370	145	195	50	350	119	380	430
$\phi 150$	$\phi 30$	221	123 ± 0.25	30	18	75	$\square 196$	Rc1	11	71	240	146	390	155	210	50	365	121	395	422
$\phi 160$	$\phi 33$	237	132 ± 0.25	35	18	75	$\square 210$	Rc1	13	74	253	156	403	170	225	55	383	129	418	440
$\phi 180$	$\phi 33$	265.5	148 ± 0.25	40	20	85	$\square 235$	Rc1 1/4	13	75	275	172	445	185	243	55	415	130	455	462
$\phi 200$	$\phi 36$	296	165 ± 0.25	40	25	98	$\square 262$	Rc1 1/2	13	85	301	184	497	206	272	55	454	140	494	488
$\phi 224$	$\phi 42$	331	185 ± 0.25	45	30	115	$\square 292$	Rc1 1/2	13	89	305	184	535	230	310	60	480	149	525	497
$\phi 250$	$\phi 45$	370.5	208 ± 0.25	50	35	130	$\square 325$	Rc2	13	106	346	200	606	250	335	65	541	171	591	543

- The tolerance of B is h8, and that of MM is f8.

Outline Drawings of Sensor Area

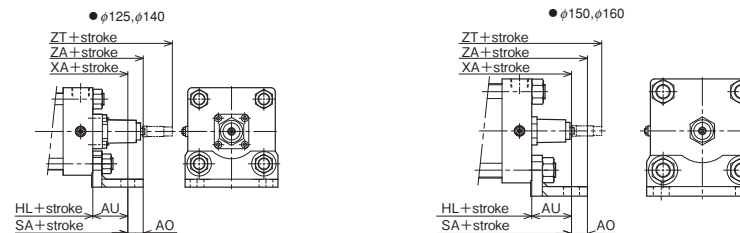

With Boots

Symbol Bore	$\phi 63$	$\phi 80$	$\phi 100$	$\phi 125$	$\phi 140$	$\phi 150$	$\phi 160$	$\phi 180$	$\phi 200$	$\phi 224$	$\phi 250$
	WW	71	80	100	125	125	140	140	160	180	180
X	55	55	55	65	65	65	65	65	65	80	80

PTN_PTH-1B/THPT1B Bore B is available.

FA For 7 MPa

PTN-1B 1 FA Bore B B Stroke - A B

● Bore φ50 to φ250

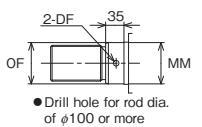

Rod dia.	OF	DF
φ100	φ99.5	φ12
φ112	φ111.5	φ15
φ125	φ124.5	φ15
φ140	φ139.5	φ15

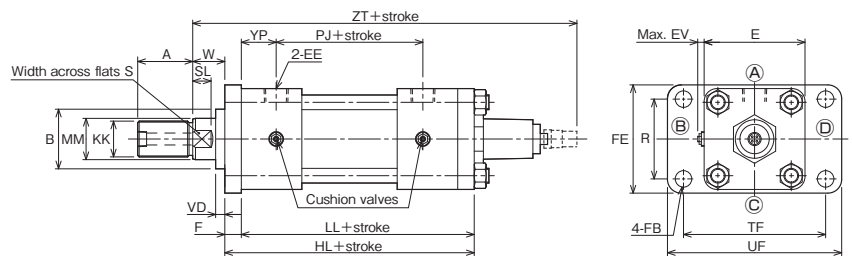

● The above figure shows a cylinder with bores from 63 to 100 mm. The shape of the sensor area differs depending on the bore.

- For dimensions not shown here, refer to the SD style.
- For the thread length (dimension A) in case of using the lock nut, refer to "Accessories".
- Some piston rods have a through hole for fitting a sensor (φ13 to φ16). If a hole is made, the thickness may be excessively reduced. It is recommended to use a lock nut to lock the rod end attachment. When drilling is performed to use a hex. screw, the drilling depth must be 2 mm or less. Do not use a spring pin.
- Switch Set Cylinders (φ50 to φ140) are manufactured as semi-standard models.
- For the mounting of sensors, refer to the dimensional drawings of "Switch Set".
- The shape of the sensor fitting area differs depending on the cylinder bore.

With Boots

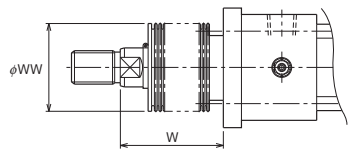

	Standard	Semi-standard	
Material	Nylon tarpaulin	Chloroprene	Conex
Heat proof	80°C	130°C	200°C

(Notes) ● Remember that the heat proof field in the table above shows the allowable temperatures for the boots, not for the cylinder.
 ● Conex is the registered trademark of Teijin Limited.
 ● The boots have been mounted at our factory prior to delivery.

Dimension W		
Nylon tarpaulin	φ50	1/3.5 stroke+X
Chloroprene	φ63 to φ100	1/4 stroke+X
	φ125 to φ200	1/5 stroke+X
	φ224 to φ250	1/6 stroke+X
Conex	φ50	1/2.5 stroke+X
	φ63 to φ100	1/3 stroke+X
	φ125-φ140	1/3.5 stroke+X
	φ150 to φ200	1/4 stroke+X
	φ224-φ250	1/4.5 stroke+X

● If the calculated value has a fractional part, round it up.

Dimensional Table

Symbol	Rod B						
	A	B	KK	MM	S	SL	VD
φ50	35	φ46	M24×1.5	φ28	24	14	10
φ63	45	φ55	M30×1.5	φ35.5	30	16	10
φ80	60	φ65	M39×1.5	φ45	41	20	10
φ100	75	φ80	M48×1.5	φ56	50	23	10
φ125	95	φ95	M64×2	φ71	65	27	10
φ140	110	φ105	M72×2	φ80	75	31	10
φ150	115	φ110	M76×2	φ85	80	33	10
φ160	120	φ115	M80×2	φ90	85	33	10
φ180	140	φ125	M95×2	φ100	—	—	10
φ200	150	φ140	M100×2	φ112	—	—	10
φ224	180	φ150	M120×2	φ125	—	—	10
φ250	195	φ170	M130×2	φ140	—	—	10

Symbol	E	EE	EV	F	FB	FE	HL	LL	PJ	R	TF	UF	W	YP	ZT
φ50	□76	Rc1/2	7	13	φ14	85	182	169	98	58	115	145	30	29	355
φ63	□90	Rc1/2	7	15	φ18	98	194	179	102	65	132	165	35	31	361
φ80	□110	Rc3/4	7	18	φ18	118	222	204	110	87	155	190	35	38	389
φ100	□135	Rc3/4	7	20	φ22	150	232	212	116	109	190	230	40	38	404
φ125	□165	Rc1	11	24	φ26	175	220	196	130	130	224	272	45	43	415
φ140	□185	Rc1	11	26	φ26	195	230	204	138	145	250	300	50	43	430
φ150	□196	Rc1	11	28	φ30	210	240	212	146	155	270	320	50	43	422
φ160	□210	Rc1	13	31	φ33	225	253	222	156	170	285	345	55	43	440
φ180	□235	Rc1 1/4	13	33	φ33	243	275	242	172	185	315	375	55	42	462
φ200	□262	Rc1 1/2	13	37	φ36	272	301	264	184	206	355	425	55	48	488
φ224	□292	Rc1 1/2	13	41	φ42	310	305	264	184	230	395	475	60	48	497
φ250	□325	Rc2	13	46	φ45	335	346	300	200	250	425	515	65	60	543

● The tolerance of B is h8, and that of MM is f8.

Outline Drawings of Sensor Area

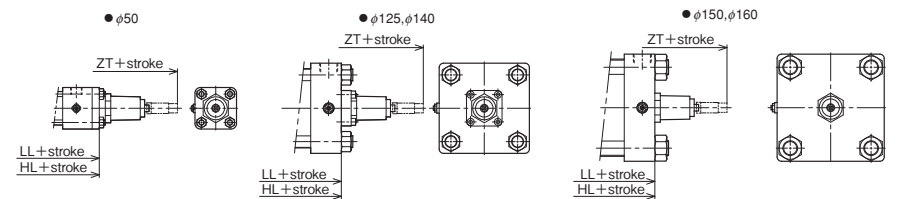

With Boots

Bore	φ50	φ63	φ80	φ100	φ125	φ140	φ150	φ160	φ180	φ200	φ224	φ250
WW	63	71	80	100	125	125	140	140	160	180	180	200
X	45	55	55	55	65	65	65	65	65	65	80	80

PTN_PTH-1B/THPT1B Bore B is available.

FY

PTN-1B	1	FY	Bore	B	B	Stroke	-	A	B
PTH-1B	1	FY	Bore	B	B	Stroke	-	A	B

● Bore φ50 to φ250

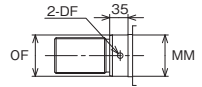

Rod dia.	OF	DF
φ100	φ99.5	φ12
φ112	φ111.5	φ15
φ125	φ124.5	φ15
φ140	φ139.5	φ15

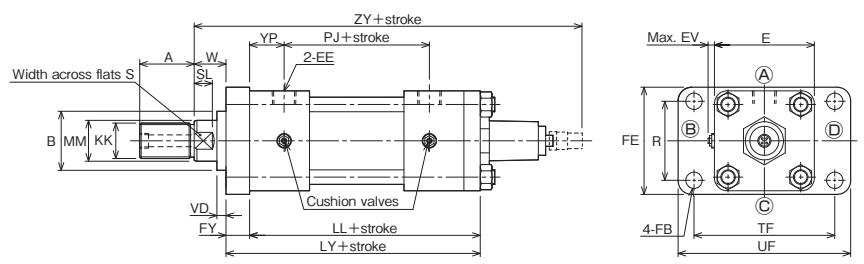

● The above figure shows a cylinder with bores from 63 to 100 mm. The shape of the sensor area differs depending on the bore.

- For dimensions not shown here, refer to the SD style.
- For the thread length (dimension A) in case of using the lock nut, refer to "Accessories".
- Some piston rods have a through hole for fitting a sensor (φ13 to φ16). If a hole is made, the thickness may be excessively reduced. It is recommended to use a lock nut to lock the rod end attachment. When drilling is performed to use a hex. screw, the drilling depth must be 2 mm or less. Do not use a spring pin.
- Switch Set Cylinders (φ50 to φ140) are manufactured as semi-standard models.
- For the mounting of sensors, refer to the dimensional drawings of "Switch Set".
- The shape of the sensor fitting area differs depending on the cylinder bore.

With Boots

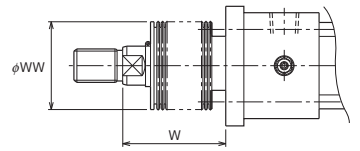

	Standard	Semi-standard	
Material	Nylon tarpaulin	Chloroprene	Conex
Heat proof	80°C	130°C	200°C

(Notes) ● Remember that the heat proof field in the table above shows the allowable temperatures for the boots, not for the cylinder.
● Conex is the registered trademark of Teijin Limited.
● The boots have been mounted at our factory prior to delivery.

Dimension W		
Nylon tarpaulin	φ50	1/3.5 stroke+X
Chloroprene	φ63 to φ100	1/4 stroke+X
	φ125 to φ200	1/5 stroke+X
	φ224 to φ250	1/6 stroke+X
Conex	φ50	1/2.5 stroke+X
	φ63 to φ100	1/3 stroke+X
	φ125-φ140	1/3.5 stroke+X
	φ150 to φ200	1/4 stroke+X
	φ224-φ250	1/4.5 stroke+X

● If the calculated value has a fractional part, round it up.

Dimensional Table

Symbol	Rod B						
	A	B	KK	MM	S	SL	VD
φ50	35	φ46	M24×1.5	φ28	24	14	10
φ63	45	φ55	M30×1.5	φ35.5	30	16	10
φ80	60	φ65	M39×1.5	φ45	41	20	10
φ100	75	φ80	M48×1.5	φ56	50	23	10
φ125	95	φ95	M64×2	φ71	65	27	10
φ140	110	φ105	M72×2	φ80	75	31	10
φ150	115	φ110	M76×2	φ85	80	33	10
φ160	120	φ115	M80×2	φ90	85	33	10
φ180	140	φ125	M95×2	φ100	-	-	10
φ200	150	φ140	M100×2	φ112	-	-	10
φ224	180	φ150	M120×2	φ125	-	-	10
φ250	195	φ170	M130×2	φ140	-	-	10

Symbol	E	EE	EV	FB	FE	FY	LL	LY	PJ	R	TF	UF	W	YP	ZY
φ50	□76	Rc1/2	7	φ14	85	18	169	187	98	58	115	145	30	29	360
φ63	□90	Rc1/2	7	φ18	98	20	179	199	102	65	132	165	35	31	366
φ80	□110	Rc3/4	7	φ18	118	24	204	228	110	87	155	190	35	38	395
φ100	□135	Rc3/4	7	φ22	150	28	212	240	116	109	190	230	40	38	412
φ125	□165	Rc1	11	φ26	175	33	196	229	130	130	224	272	45	43	424
φ140	□185	Rc1	11	φ26	195	37	204	241	138	145	250	300	50	43	441
φ150	□196	Rc1	11	φ30	210	39	212	251	146	155	270	320	50	43	433
φ160	□210	Rc1	13	φ33	225	41	222	263	156	170	285	345	55	43	450
φ180	□235	Rc1 1/4	13	φ33	243	46	242	288	172	185	315	375	55	42	475
φ200	□262	Rc1 1/2	13	φ36	272	51	264	315	184	206	355	425	55	48	502
φ224	□292	Rc1 1/2	13	φ42	310	58	264	322	184	230	395	475	60	48	514
φ250	□325	Rc2	13	φ45	335	65	300	365	200	250	425	515	65	60	562

● The tolerance of B is h8, and that of MM is f8.

Outline Drawings of Sensor Area

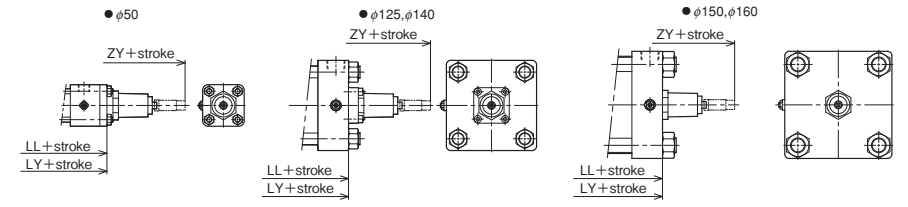

With Boots

Bore	φ50	φ63	φ80	φ100	φ125	φ140	φ150	φ160	φ180	φ200	φ224	φ250
WW	63	71	80	100	125	125	140	140	160	180	180	200
X	45	55	55	55	65	65	65	65	65	65	80	80

PTN_PTH-1B/THPT1B [Bore] B is available. CAD/DATA [i]

TA

PTN-1B	1	TA	[Bore] B	[B] B	[Stroke] C	-	A	C
PTH-1B	1	TA	[Bore] B	[B] B	[Stroke] C	-	A	C

● Bore φ50 to φ160

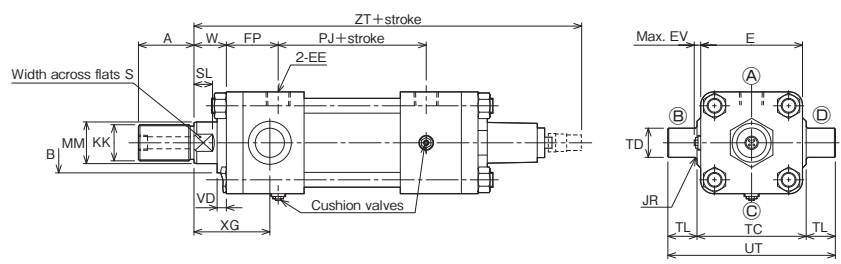

● The above figure shows a cylinder with bores from 63 to 100 mm. The shape of the sensor area differs depending on the bore.

- For dimensions not shown here, refer to the SD style.
- For the thread length (dimension A) in case of using the lock nut, refer to "Accessories".
- Some piston rods have a through hole for fitting a sensor (φ13 to φ16). If a hole is made, the thickness may be excessively reduced. It is recommended to use a lock nut to lock the rod end attachment. When drilling is performed to use a hex. screw, the drilling depth must be 2 mm or less. Do not use a spring pin.
- Switch Set Cylinders (φ50 to φ140) are manufactured as semi-standard models.
- For the mounting of sensors, refer to the dimensional drawings of "Switch Set".
- The shape of the sensor fitting area differs depending on the cylinder bore.

With Boots

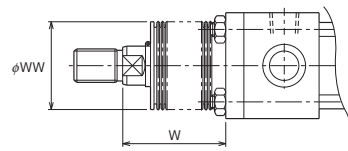

Material	φ50	φ63 to φ100	φ125 to φ160
Nylon tarpaulin	1/3.5 stroke+X	1/4 stroke+X	1/5 stroke+X
Chloroprene	1/3.5 stroke+X	1/4 stroke+X	1/5 stroke+X
Conex	1/2.5 stroke+X	1/3 stroke+X	1/4 stroke+X

	Standard	Semi-standard	
Material	Nylon tarpaulin	Chloroprene	Conex
Heat proof	80°C	130°C	200°C

Notes) ● Remember that the heat proof field in the table above shows the allowable temperatures for the boots, not for the cylinder.
 ● Conex is the registered trademark of Teijin Limited.
 ● The boots have been mounted at our factory prior to delivery.

● If the calculated value has a fractional part, round it up.

Dimensional Table

Symbol	Rod B						
	A	B	KK	MM	S	SL	VD
φ50	35	φ46	M24×1.5	φ28	24	14	10
φ63	45	φ55	M30×1.5	φ35.5	30	16	10
φ80	60	φ65	M39×1.5	φ45	41	20	10
φ100	75	φ80	M48×1.5	φ56	50	23	10
φ125	95	φ95	M64×2	φ71	65	27	10
φ140	110	φ105	M72×2	φ80	75	31	10
φ150	115	φ110	M76×2	φ85	80	33	10
φ160	120	φ115	M80×2	φ90	85	33	10

Symbol	E	EE	EV	FP	JR	PJ	TC	TD	TL	UT	W	XG	ZT
φ50	□76	Rc1/2	7	42	R2.5	98	85 ^{-0.35}	φ25e9	25	135	30	66	355
φ63	□90	Rc1/2	7	46	R2.5	102	98 ^{-0.35}	φ31.5e9	31.5	161	35	74	361
φ80	□110	Rc3/4	7	56	R2.5	110	118 ^{-0.35}	φ31.5e9	31.5	181	35	82	389
φ100	□135	Rc3/4	7	58	R3	116	145 ^{-0.4}	φ40e9	40	225	40	89	404
φ125	□165	Rc1	11	67	R3	130	175 ^{-0.4}	φ50e9	50	275	45	103	415
φ140	□185	Rc1	11	69	R4	138	195 ^{-0.46}	φ63e9	63	321	50	112	430
φ150	□196	Rc1	11	71	R4	146	206 ^{-0.46}	φ63e9	63	332	50	112	422
φ160	□210	Rc1	13	74	R4	156	218 ^{-0.46}	φ71e9	71	360	55	126	440

● The tolerance of B is h8, and that of MM is f8.

Outline Drawings of Sensor Area

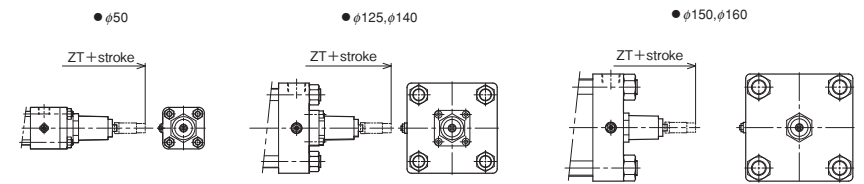

With Boots

Bore	φ50	φ63	φ80	φ100	φ125	φ140	φ150	φ160
WW	63	71	80	100	125	125	140	140
X	45	55	55	55	65	65	65	65

PTN_PTH-1B/THPT1B [Bore] B is available.

TC

PTN-1B	1	TC	Bore	B	B	Stroke	-	A	B
PTH-1B	1	TC	Bore	B	B	Stroke	-	A	B

● Bore φ50 to φ250

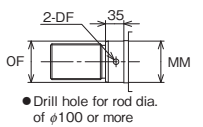

Rod dia.	OF	DF
φ100	φ99.5	φ12
φ112	φ111.5	φ15
φ125	φ124.5	φ15
φ140	φ139.5	φ15

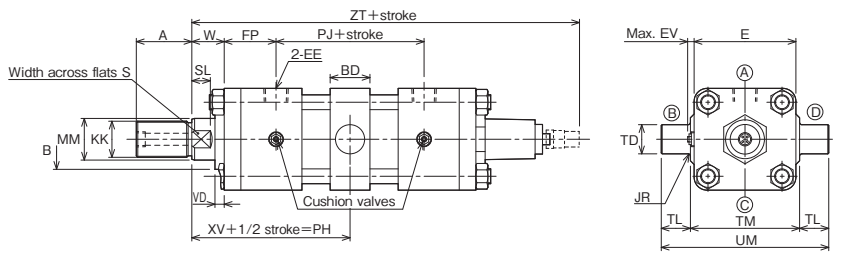

● The above figure shows a cylinder with bores from 63 to 100 mm. The shape of the sensor area differs depending on the bore.

- For dimensions not shown here, refer to the SD style.
- For the thread length (dimension A) in case of using the lock nut, refer to "Accessories".
- Some piston rods have a through hole for fitting a sensor (φ13 to φ16). If a hole is made, the thickness may be excessively reduced. It is recommended to use a lock nut to lock the rod end attachment. When drilling is performed to use a hex. screw, the drilling depth must be 2 mm or less. Do not use a spring pin.
- Switch Set Cylinders (φ50 to φ140) are manufactured as semi-standard models.
- For the mounting of sensors, refer to the dimensional drawings of "Switch Set".
- The shape of the sensor fitting area differs depending on the cylinder bore.
- To change the position of the TC attachment, specify dimension PH.

With Boots

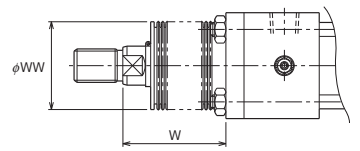

	Standard	Semi-standard	
Material	Nylon tarpaulin	Chloroprene	Conex
Heat proof	80°C	130°C	200°C

Notes) ● Remember that the heat proof field in the table above shows the allowable temperatures for the boots, not for the cylinder.
 ● Conex is the registered trademark of Teijin Limited.
 ● The boots have been mounted at our factory prior to delivery.

Dimension W		
Nylon tarpaulin	φ50	1/3.5 stroke+X
Chloroprene	φ63 to φ100	1/4 stroke+X
	φ125 to φ200	1/5 stroke+X
	φ224 to φ250	1/6 stroke+X
Conex	φ50	1/2.5 stroke+X
	φ63 to φ100	1/3 stroke+X
	φ125-φ140	1/3.5 stroke+X
	φ150 to φ200	1/4 stroke+X
	φ224-φ250	1/4.5 stroke+X

● If the calculated value has a fractional part, round it up.

Dimensional Table

Symbol	Rod B						
	A	B	KK	MM	S	SL	VD
φ50	35	φ46	M24×1.5	φ28	24	14	10
φ63	45	φ55	M30×1.5	φ35.5	30	16	10
φ80	60	φ65	M39×1.5	φ45	41	20	10
φ100	75	φ80	M48×1.5	φ56	50	23	10
φ125	95	φ95	M64×2	φ71	65	27	10
φ140	110	φ105	M72×2	φ80	75	31	10
φ150	115	φ110	M76×2	φ85	80	33	10
φ160	120	φ115	M80×2	φ90	85	33	10
φ180	140	φ125	M95×2	φ100	-	-	10
φ200	150	φ140	M100×2	φ112	-	-	10
φ224	180	φ150	M120×2	φ125	-	-	10
φ250	195	φ170	M130×2	φ140	-	-	10

Symbol	BD	E	EE	EV	FP	JR	Min. PH	PJ	TD	TL	TM	UM	W	XV	ZT
φ50	33	□76	Rc1/2	7	42	R2.5	113.5	98	φ25e9	25	85 ⁰ _{-0.35}	135	30	121	355
φ63	43	□90	Rc1/2	7	46	R2.5	127.5	102	φ31.5e9	31.5	98 ⁰ _{-0.35}	161	35	132	361
φ80	43	□110	Rc3/4	7	56	R2.5	140.5	110	φ31.5e9	31.5	118 ⁰ _{-0.35}	181	35	146	389
φ100	53	□135	Rc3/4	7	58	R3	152.5	116	φ40e9	40	145 ⁰ _{-0.4}	225	40	156	404
φ125	58	□165	Rc1	11	67	R3	174	130	φ50e9	50	175 ⁰ _{-0.4}	275	45	177	415
φ140	78	□185	Rc1	11	69	R4	191	138	φ63e9	63	195 ⁰ _{-0.46}	321	50	188	430
φ150	78	□196	Rc1	11	71	R4	193	146	φ63e9	63	206 ⁰ _{-0.46}	332	50	194	422
φ160	88	□210	Rc1	13	74	R4	211	156	φ71e9	71	218 ⁰ _{-0.46}	360	55	207	440
φ180	98	□235	Rc1 1/4	13	75	R4	225	172	φ80e9	80	243 ⁰ _{-0.46}	403	55	216	462
φ200	108	□262	Rc1 1/2	13	85	R5	244	184	φ90e9	90	272 ⁰ _{-0.52}	452	55	232	488
φ224	117	□292	Rc1 1/2	13	89	R5	257.5	184	φ100e9	100	300 ⁰ _{-0.52}	500	60	241	497
φ250	117	□325	Rc2	13	106	R5	287.5	200	φ100e9	100	335 ⁰ _{-0.57}	535	65	271	543

● The tolerance of B is h8, and that of MM is f8.

Outline Drawings of Sensor Area

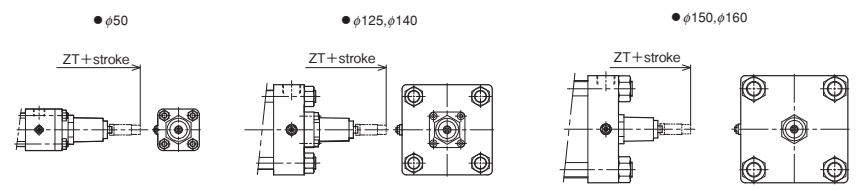

With Boots

Bore	φ50	φ63	φ80	φ100	φ125	φ140	φ150	φ160	φ180	φ200	φ224	φ250
WW	63	71	80	100	125	125	140	140	160	180	180	200
X	45	55	55	55	65	65	65	65	65	65	80	80

Switch Set (semi-standard)

PTN-1BR	2	SD	Bore	B	B	200	-	A	B	Sensor symbol	Sensor quantity
PTH-1BR	2	SD	Bore	B	B	200	-	A	B	Sensor symbol	Sensor quantity

AX type (reed sensor), AX type (solid state sensor)

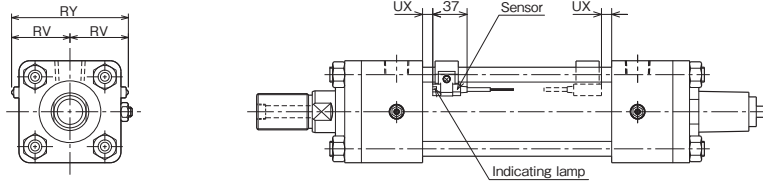

WR type (reed sensor), WS type (solid state sensor/2-wire, 2-LED type) (cutting oil proof type)

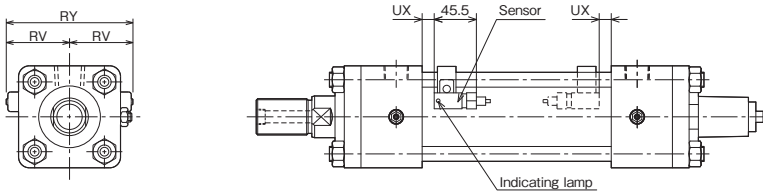

Minimum dimension PH of Switch Set Cylinders PTN-1BR and PTH-1BR

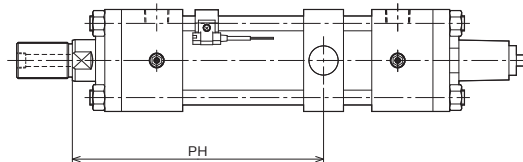

● The minimum dimension PH of a Switch Set Cylinder is obtained when the sensor is mounted on the rod side and the trunnion is moved as close to the rod as possible as shown above.

When boots are provided, dimension W changes. In such a case, specify dimension PH.

Dimensional Table

Symbol Bore	RV		RY		UX			Min. dimension PH			
	AX type	WR/WS type	AX type	WR/WS type	AX type		WR type	WS type	AX type	WR type	WS type
					Reed sensor	Solid state sensor					
φ50	43	47	86	94	15	9	14	178.5	198.5	203.5	
φ63	50	53	100	106	17	13	16	196.5	216.5	218.5	
φ80	60	63	120	126	19	13	17	211.5	229.5	233.5	
φ100	70	72	140	144	21	14	21	224.5	242.5	249.5	
φ125	83	85	166	170	23	19	23	250	269	273	
φ140	91	—	182	—	26	—	—	280	—	—	

Note) Dimension UX indicates the optimum sensor mounting position for detection of stroke end.

Operating Range and Hysteresis

Bore (mm)	Reed sensor				Solid state sensor			
	AX1**		WR type		AX2**		WS type	
	Operating range	Hysteresis	Operating range	Hysteresis	Operating range	Hysteresis	Operating range	Hysteresis
φ50	4 to 14	2 or less	6 to 12	2 or less	3 to 8	1 or less	10 to 14	1 or less
φ63							11 to 17	
φ80	10 to 17		12 to 18					
φ100	5 to 15		—					
φ125	11 to 20	—	—	—	6 to 13	—	—	

Rod End Attachment

Rod eye (T-end)

φ50 to φ160

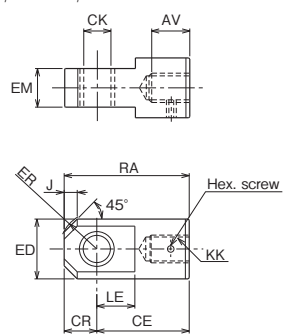

φ180 to φ250

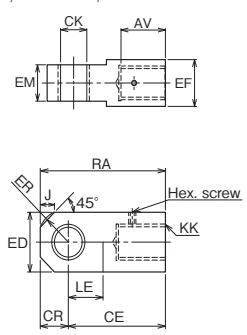

Rod clevis (Y-end) with pin

φ50 to φ80

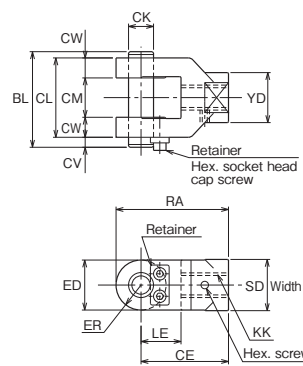

φ100

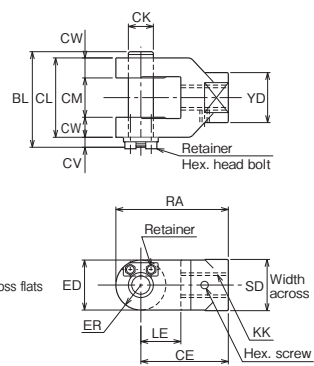

φ125 to φ250

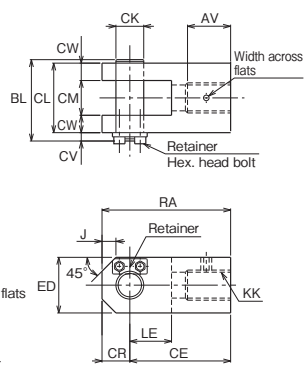

Floating joint (F-end)

Note) PTN-1B Series only (7 MPa specifications)

Applicable series

- PTN-1B
- PTN-1BR

- Notes)
- The insertion of the floating joint into the socket shall not equal or exceed the dimension of screw diameter. (Return the joint one or two turns after it gets into contact with the socket bottom, and fix it with a lock nut.) Excessive insertion can cause operation failure.
 - DO NOT use together with TA and TC accessories.
 - When using the floating joint, use the lock nut.
 - Make an order for the cylinder rod end lock nut at the same time.

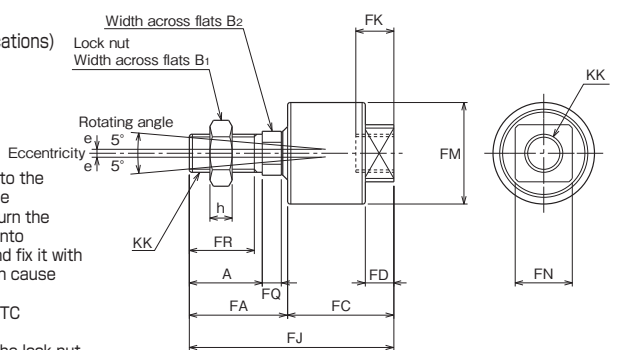

Dimensional Table: Rod eye (T-end)

Symbol	Part number	AV	CE	CK	CR	ED	EF	EM	ER	J	KK	LE	RA
Bore													
φ50	RTH-24-H	37	70	φ20H10	25	φ49	—	31.5 ^{-0.1} _{-0.4}	R29	10	M24×1.5	28	95
φ63	RTH-30-H	47	115	φ31.5H10	35	φ62	—	40 ^{-0.1} _{-0.4}	R39	15	M30×1.5	43	150
φ80	RTH-39-H	62	115	φ31.5H10	35	φ62	—	40 ^{-0.1} _{-0.4}	R39	15	M39×1.5	43	150
φ100	RTH-48-H	77	145	φ40H10	40	φ79	—	50 ^{-0.1} _{-0.4}	R45	20	M48×1.5	55	185
φ125	RTH-64-H	97	180	φ50H10	50	φ100	—	63 ^{-0.1} _{-0.4}	R54	30	M64×2	65	230
φ140	RTH-72-H	112	225	φ63H10	65	φ130	—	80 ^{-0.1} _{-0.4}	R74	30	M72×2	85	290
φ150	RTH-76-H	117	225	φ63H10	65	φ130	—	80 ^{-0.1} _{-0.4}	R74	30	M76×2	85	290
φ160	RTH-80-H	122	240	φ71H10	70	φ140	—	80 ^{-0.1} _{-0.6}	R77	40	M80×2	90	310
φ180	RTH-95-H	142	280	φ80H10	80	160	130	100 ^{-0.1} _{-0.6}	R90	40	M95×2	100	360
φ200	RTH-100-H	152	310	φ90H10	90	180	140	125 ^{-0.1} _{-0.6}	R99	50	M100×2	120	400
φ224	RTH-120-H	182	370	φ100H10	100	200	170	125 ^{-0.1} _{-0.6}	R112	50	M120×2	130	470
φ250	RTH-130-H	197	370	φ100H10	100	200	180	125 ^{-0.1} _{-0.6}	R112	50	M130×2	130	470

Dimensional Table: Rod clevis (Y-end) with pin

Symbol	Part number	AV	BL	CE	CK	CL	CM	CR	CV	CW	ED	ER	J	KK	LE	RA	SD	YD
Bore																		
φ50	RYH-24-H	—	76.5	70	φ20 ^{H10} / _{T8}	63.5	31.5 ^{+0.4} _{+0.1}	—	8	16	40	R20	—	M24×1.5	32	90	41	40
φ63	RYH-30-H	—	93	115	φ31.5 ^{H10} / _{T8}	80	40 ^{+0.4} _{+0.1}	—	8	20	60	R30	—	M30×1.5	50	145	60	60
φ80	RYH-39-H	—	93	115	φ31.5 ^{H10} / _{T8}	80	40 ^{+0.4} _{+0.1}	—	8	20	60	R30	—	M39×1.5	50	145	60	60
φ100	RYH-48-H	—	117	145	φ40 ^{H10} / _{T8}	100	50 ^{+0.4} _{+0.1}	—	12	25	80	R40	—	M48×1.5	60	185	80	80
φ125	RYH-64-H	97	143	180	φ50 ^{H10} / _{T8}	126	63 ^{+0.4} _{+0.1}	50	12	31.5	100	R54	30	M64×2	70	230	—	—
φ140	RYH-72-H	112	183	225	φ63 ^{H10} / _{T8}	160	80 ^{+0.6} _{+0.1}	65	18	40	120	R72	30	M72×2	90	290	—	—
φ150	RYH-76-H	117	183	225	φ63 ^{H10} / _{T8}	160	80 ^{+0.6} _{+0.1}	65	18	40	120	R72	30	M76×2	90	290	—	—
φ160	RYH-80-H	122	183	240	φ71 ^{H10} / _{T8}	160	80 ^{+0.6} _{+0.1}	70	18	40	140	R77	40	M80×2	100	310	—	—
φ180	RYH-95-H	142	210	280	φ80 ^{H10} / _{T8}	180	100 ^{+0.6} _{+0.1}	80	24	40	160	R90	40	M95×2	110	360	—	—
φ200	RYH-100-H	152	260	310	φ90 ^{H10} / _{T8}	230	125 ^{+0.6} _{+0.1}	90	24	52.5	180	R99	50	M100×2	130	400	—	—
φ224	RYH-120-H	182	280	370	φ100 ^{H10} / _{T8}	250	125 ^{+0.6} _{+0.1}	100	24	62.5	200	R112	50	M120×2	140	470	—	—
φ250	RYH-130-H	197	280	370	φ100 ^{H10} / _{T8}	250	125 ^{+0.6} _{+0.1}	100	24	62.5	200	R112	50	M130×2	140	470	—	—

Dimensional Table: Floating joint (F-end)

Symbol	Part number	A	B ₁	B ₂	e	FA	FC	FD	FJ	FK	FM	FN	FQ	FR	h	KK
Bore																
φ50	RFH-24	46	32	24	2.5	62	67	18	129	24	φ64	36	12	41	14	M24×1.5
φ63	RFH-30	58	41	32	2.5	78	83	21	161	30	φ76	46	14	52	17	M30×1.5

Parallel pin

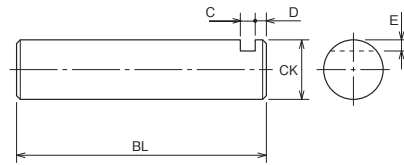

Retainer

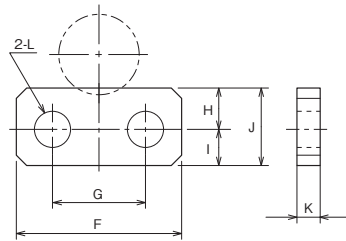

Dimensional Table: Parallel pin

Symbol	BL	C	CK	D	E
Bore					
φ50	76.5	5	φ20	3	3
φ63	93	5	φ31.5	3	4.75
φ80	93	5	φ31.5	3	4.75
φ100	117	7	φ40	5	5
φ125	143	7	φ50	5	5
φ140	183	10	φ63	8	8
φ150	183	10	φ63	8	8
φ160	183	10	φ71	8	8

● The tolerance of CK is f8.

Dimensional Table: Retainer

Symbol	F	G	H	I	J	K	L	Retainer mounting bolt size
Bore								
φ50	32	18	7.5	7.5	15	4.5	φ7	M6
φ63	32	18	7.5	7.5	15	4.5	φ7	M6
φ80	32	18	7.5	7.5	15	4.5	φ7	M6
φ100	50	30	10	10	20	6	φ10	M8
φ125	65	40	12	10	22	6	φ12	M10
φ140	75	48	17	13	30	9	φ14	M12
φ150	75	48	17	13	30	9	φ14	M12
φ160	75	48	17	13	30	9	φ14	M12

Lock nut

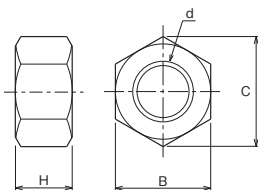

The standard fitting length of the rod end attachment and piston rod is about 80% of the thread diameter. If the fitting length is insufficient due to the use of the lock nut, it is necessary to increase the thread length (dimension A) as shown below.

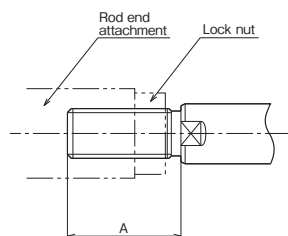

Dimensional Table: Lock nut

Symbol Bore	Part number	B	C	d	H
φ50	LNH-24F-H	32	37.0	M24×1.5	14
φ63	LNH-30F-H	41	47.3	M30×1.5	17
φ80	LNH-39F-H	55	63.5	M39×1.5	20
φ100	LNH-48F-H	70	80.8	M48×1.5	26
φ125	LNH-64F-H	90	104	M64×2	35
φ140	LNH-72F-H	100	115	M72×2	38
φ150	LNH-76F-H	105	121	M76×2	40
φ160	LNH-80F-H	110	127	M80×2	43
φ180	LNH-95F-H	130	150	M95×2	47
φ200	LNH-100F-H	135	156	M100×2	50
φ224	LNH-120F-H	165	191	M120×2	60
φ250	LNH-130F-H	180	208	M130×2	65

Symbol Bore	Dimension A
φ32	40
φ40	45
φ50	50
φ63	60
φ80	80
φ100	95
φ125	125
φ140	140
φ150	150
φ160	155
φ180	180
φ200	190
φ224	230
φ250	250

Setting method of sensor detecting position

AX type

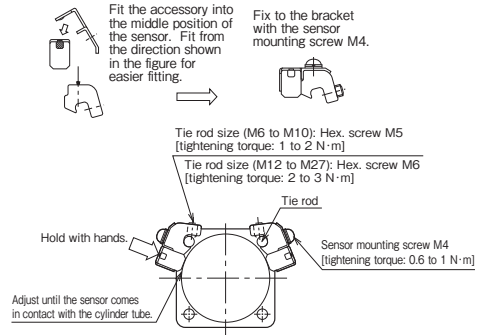

WR type/WS type

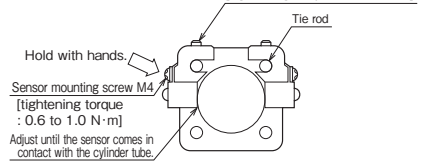

1. Loosen the two hex. screws with a hex. wrench, and move them along the tie rod.
 2. Adjust the detecting position (for the 2-LED type, the position where the green lamp lights up) 2 to 5 mm (about half of the operating range is appropriate) before the required position where the sensor indicator lamp starts to light up (ON). Then, gently hold the top of the sensor so that the cylinder tube contacts the detecting face of the sensor, and clamp the hex. screw to an appropriate tightening torque.
- Note) Inappropriate tightening torque may cause the off-center of the sensor position.
3. The indicating lamp lights up when the sensor is set to the ON position.
(The lamp of SR405 goes out when the sensor turns on.)
 4. Sensors can be mounted to any of four tie rods and on the most suitable position depending on the mounting space of the cylinder and wiring method.
 5. Mount a sensor to the most suitable position to detect the stroke end with the "sensor mounting dimension" (dimension UX).

Notes on assembly

Tightening of tie rods

- DO NOT tighten only one tie rod at a time, but tighten them gradually in the order shown in the right diagram. Uneven tightening of the tie rods can cause operation failure or stick-slip.

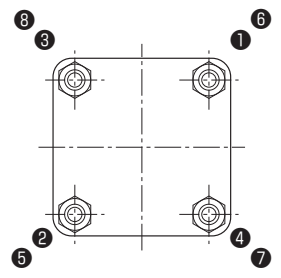

Specified Tie Rod Tightening Torque Table

Bore (mm)		φ50	φ63	φ80	φ100	φ125	φ140
Tie rod screw		M10×1.25	M12×1.5	M16×1.5	M18×1.5	M22×1.5	M24×1.5
Tightening torque (N·m)	PTN-1B	41	35	87	130	240	310
	PTH-1B		70	170	250	460	610

Bore (mm)		φ150	φ160	φ180	φ200	φ224	φ250
Tie rod screw		M27×1.5	M27×1.5	M30×1.5	M33×1.5	M39×1.5	M42×1.5
Tightening torque (N·m)	PTN-1B	450	450	630	830	1400	1800
	PTH-1B	880	880	1100	1400	2400	3000