

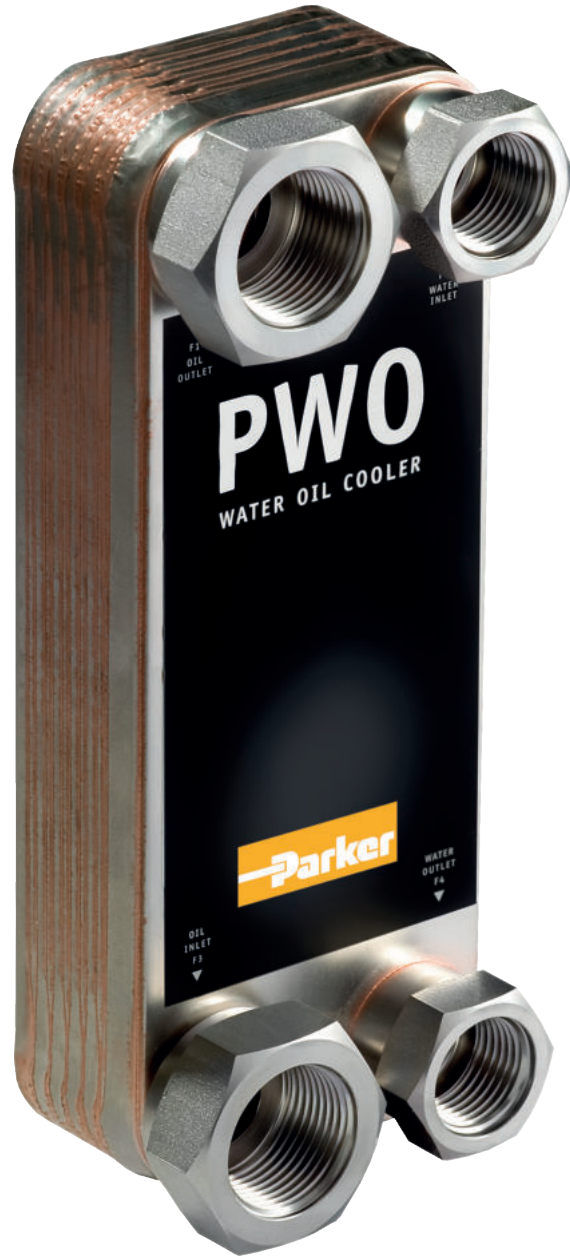

aerospace  
climate control  
electromechanical  
filtration  
fluid & gas handling  
**hydraulics**  
pneumatics  
process control  
sealing & shielding

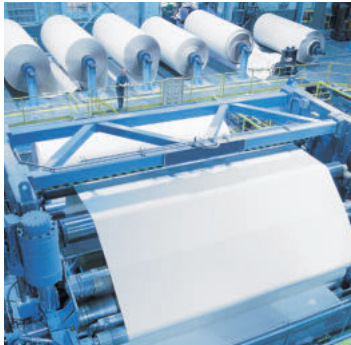

## PWO Water/oil cooler

Lightweight, compact and efficient for industrial and marine applications



ENGINEERING YOUR SUCCESS.

# A unique design

## Maintenance free optimal performance

The Parker PWO is a compact and lightweight water/oil cooler with a high cooling capacity for its size. The cooling elements consist of corrugated channel plates sandwiched between the front and rear cover plates. The channel plates are pressed and vacuum brazed in the same automated procedure, with rigorous standards of quality control.

The unique plate design provides a highly turbulent flow throughout the cooler, which is

the key to efficient cooling. This reduces the risk for clogging, which in turn makes the PWO virtually maintenance free.

### Endless possibilities

The PWO's design emphasizes a number of possibilities for versatile and efficient solutions. It can easily be adapted to a variety of needs and special applications including seawater, aggressive oils, high pressure and high temperature applications. With a PWO water/oil cooler in your

system, you can be assured that the fluid in your system is working at the correct temperature, providing maximum performance and reliability.

### PWO water/oil coolers in short:

- **Light and compact**
- **Suitable for many applications**
- **Easy installation**
- **Cost-efficient and environmentally friendly**

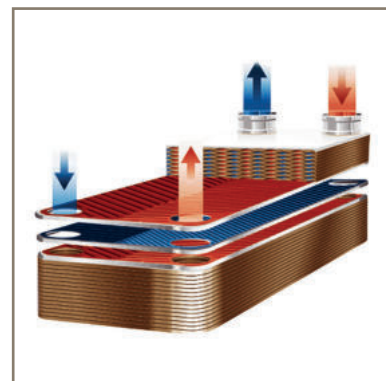

The Parker plate water/oil cooler has a unique plate design which provides a highly turbulent flow, which is the key to efficient cooling.

The Olaer Group has been part of Parker Hannifin since July 1st, 2012. With manufacturing and sales in 14 countries in North America, Asia and Europe, the Olaer Group expands Parker's presence in geographic growth areas and offers expertise in hydraulic accumulator and cooling systems for target growth markets such as oil and gas, power generation and renewable energy.



# PWO – a complete cooling system

A plate water/oil cooler range to suit all needs

**The PWO standard range** of water oil coolers is available in a wide number of sizes and is in general available for immediate off-the-shelf delivery. The basic material is stainless steel (AISI 316/304), vacuum brazed with pure copper. AISI 316 can be limited to the parts of the PWO that actually come in contact with fluid, such as the channel plates. PWO only requires small hold up volumes which equals lower cost and a more environmentally-friendly solution. Low installation cost allows for oversizing for future requirements or peak loads.

**PWO in Mo-steel** provides higher resistance against pitting, crevice corrosion and chloride-rich fluids compared to AISI 316. The state-of-the-art brazing technology eliminates the risk of intergranular corrosion. Mo-steel can be limited to the parts of the PWO that actually come in contact with fluid, such as the channel plates. Typical applications for the Mo-series are in industrial conditions where high chloride concentrations put high demands on corrosion resistance. The pulp and paper industries also often use processes with chloride-rich fluids.

**PWO in stainless steel** is free from copper. The nickel-based brazing material has increased resistance to aggressive media and can endure higher working temperatures than a copper-brazed PWO. PWO in stainless steel is used where the water supply is corrosive to copper. Other applications are cooling or heating of oil with a high content of sulphur or ammonia-based cooling systems where

copper is prohibited, as well as pharmaceutical and chemical applications where copper-brazed coolers are susceptible to corrosion from acids and bases. Another field of application is in high-temperature applications, such as heating of oils.

**PWO-M** is an extremely small water/oil cooler, perfect wherever compactness is crucial. The gaskets and the plates can be made of various materials to ensure compatibility with the refrigerant. Even if a costlier, high performance metal is required for the heat transfer surfaces, the front and back plates can be made of more basic materials to reduce cost. The snap-in-place connections allow easy assembly and the use of different metals without risk of weld deterioration. The PWO-M with plates made of titanium resists corrosive seawater in onboard engine coolers and applications containing de-ionized water or aggressive fluids. *See separate brochure, which can be downloaded from [www.parker.com](http://www.parker.com).*

**PWO with double walled channel plates** are designed for applications where high thermal efficiency is a requirement and the risk of internal leakage must be minimized. It is primarily used in sanitary water appli-



cations, coolers for the chemical process industries, food and pharmaceutical industries.

**PWO for high pressure** is designed to meet the high demands in applications with working pressures up to 45 bar (*Note: special models and configurations are available for max working pressure 120 bar*). With the exception of high pressure applications such as within the process industry, the PWO is perfect for use with new, high-capacity, environmentally-friendly refrigerants. The PWO's greater heat transfer efficiency provides opportunities linked to energy-cost and environmental savings.



Oil type: ISO VG 46  
 Oil/water flow ratio: 2/1

Inlet oil temperature 60°C at  $\Delta p$  max 2 bar  
 Inlet water temperature 20°C

**Heat Load (kW)  
 B5T**

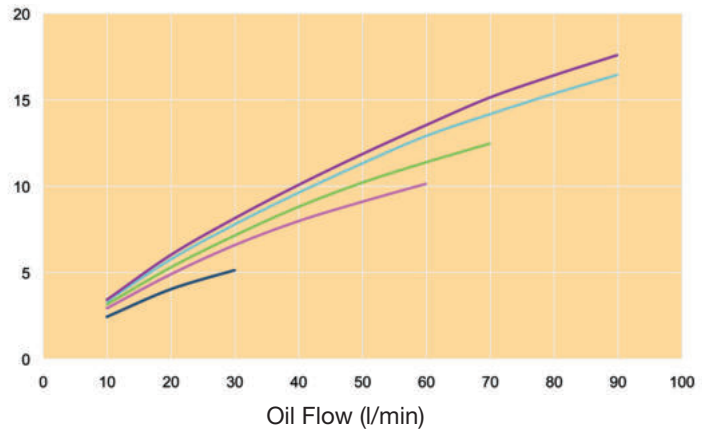
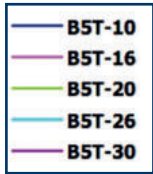

**Pressure Drop (bar)  
 B5T**

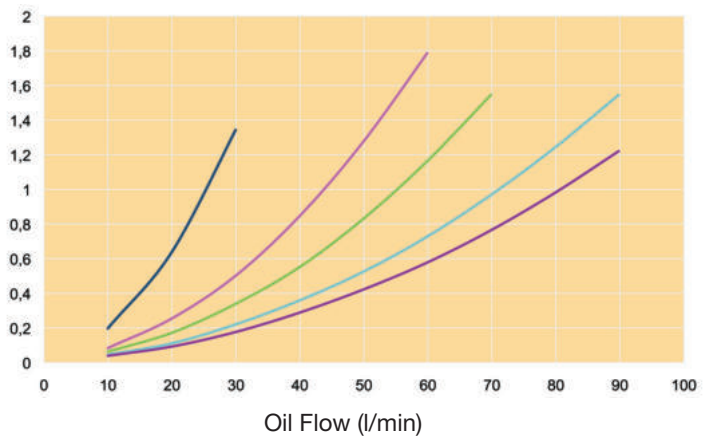
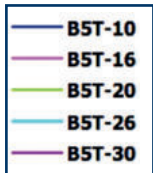

**Heat Load (kW)  
 B8T**

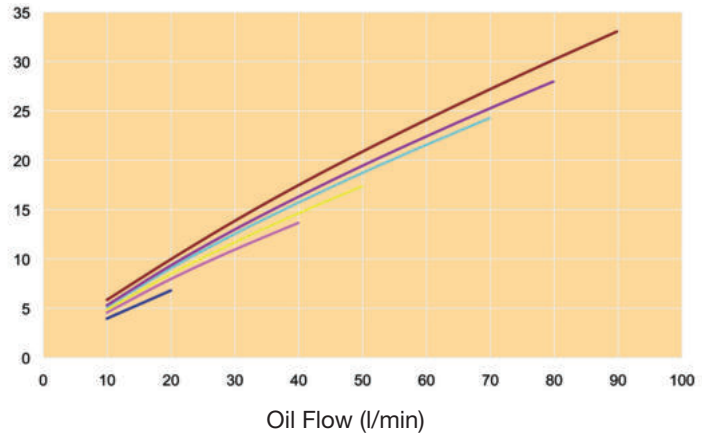
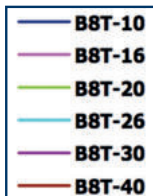

**Pressure Drop (bar)  
 B8T**

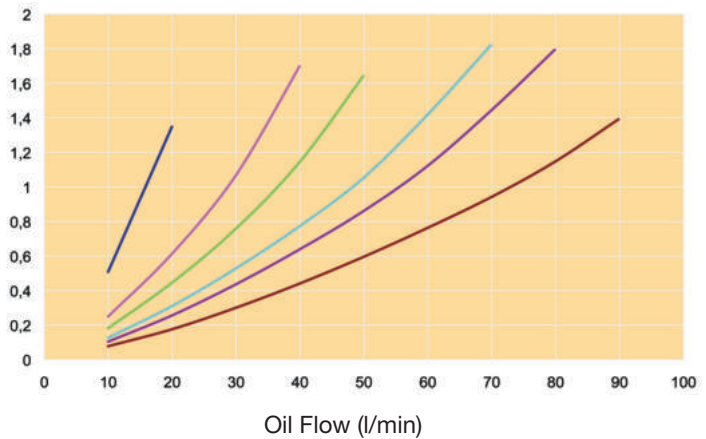
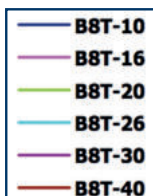

Oil type: ISO VG 46  
 Oil/water flow ratio: 2/1

Inlet oil temperature 60°C at  $\Delta p$  max 2 bar  
 Inlet water temperature 20°C

**Heat Load (kW)  
 B15**

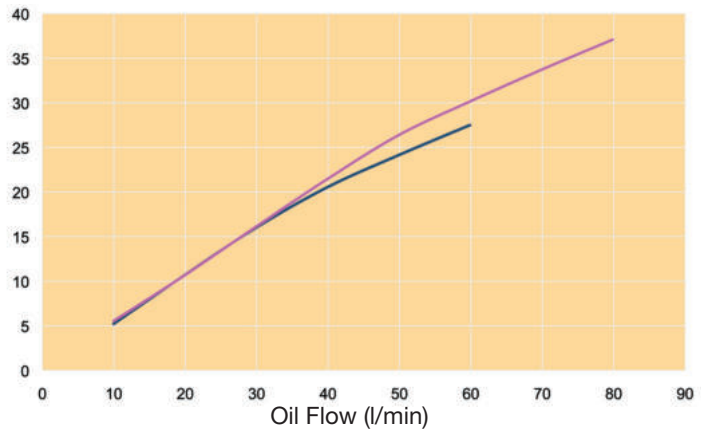
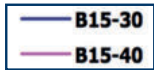

**Pressure Drop (bar)  
 B15**

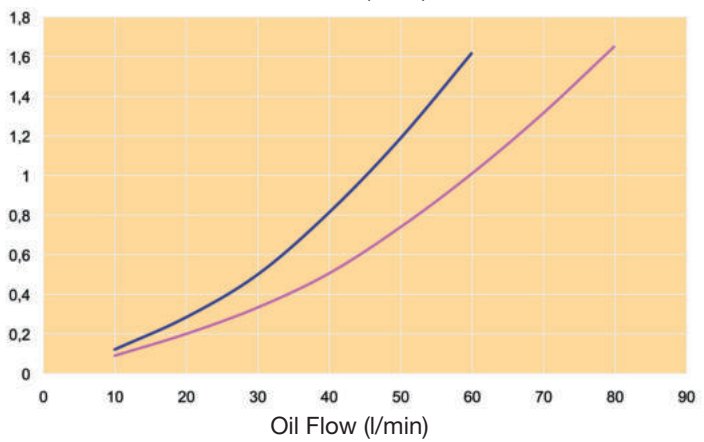

**Heat Load (kW)  
 B10T**

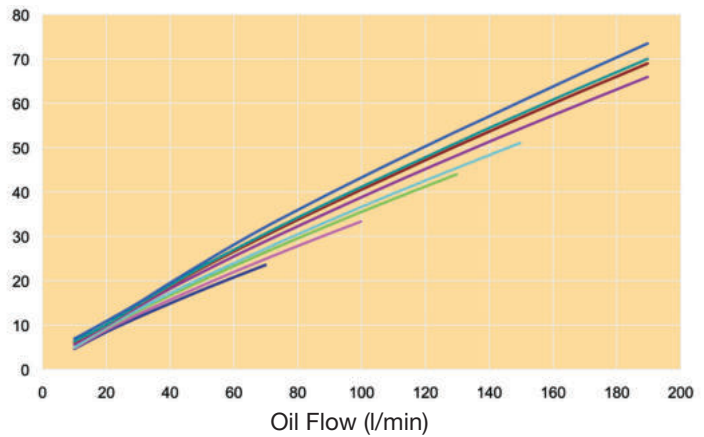
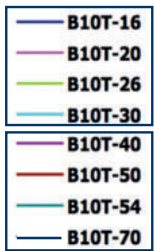

**Pressure Drop (bar)  
 B10T**

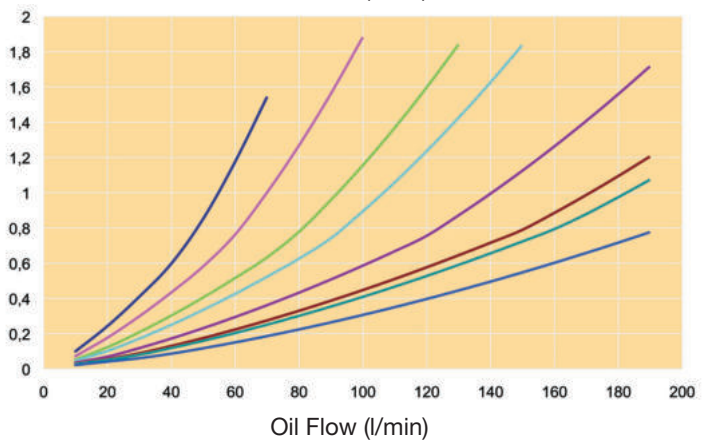
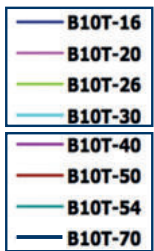

Oil type: ISO VG 46  
 Oil/water flow ratio: 2/1

Inlet oil temperature 60°C at  $\Delta p$  max 2 bar  
 Inlet water temperature 20°C

**Heat Load (kW)  
 B25T**

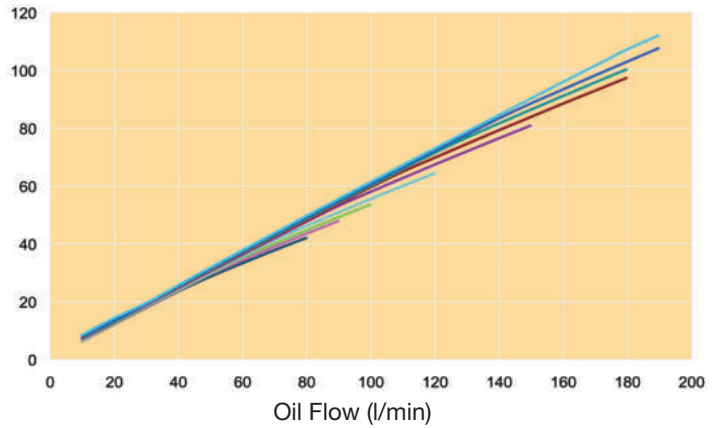
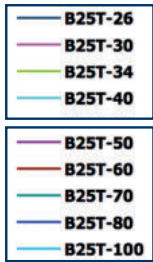

**Pressure Drop (bar)  
 B25T**

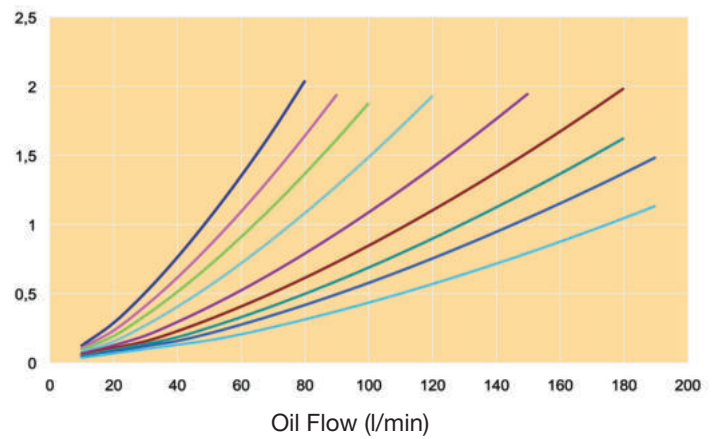
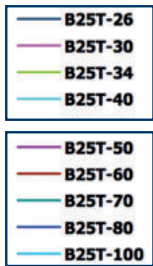

**Heat Load (kW)  
 B12**

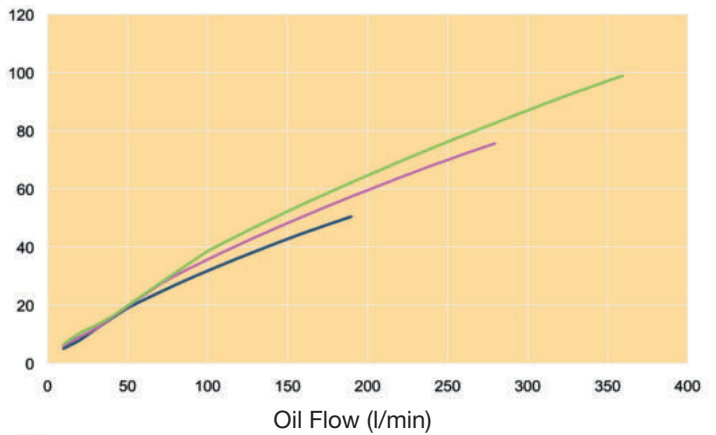

**Pressure Drop (bar)  
 B12**

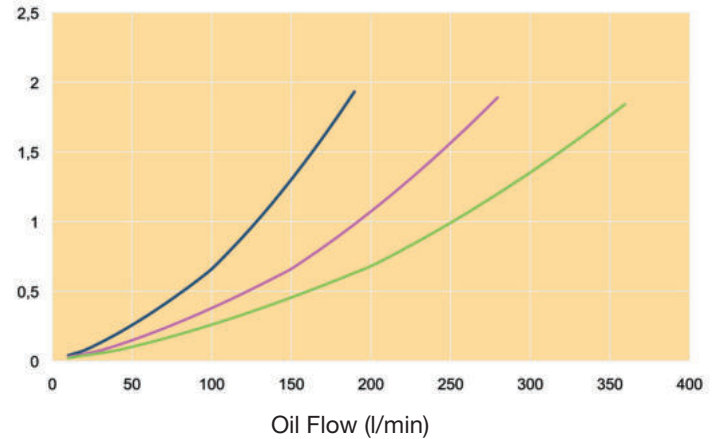

Oil type: ISO VG 46  
 Oil/water flow ratio: 2/1

Inlet oil temperature 60°C at  $\Delta p$  max 2 bar  
 Inlet water temperature 20°C

**Heat Load (kW)  
 B16**

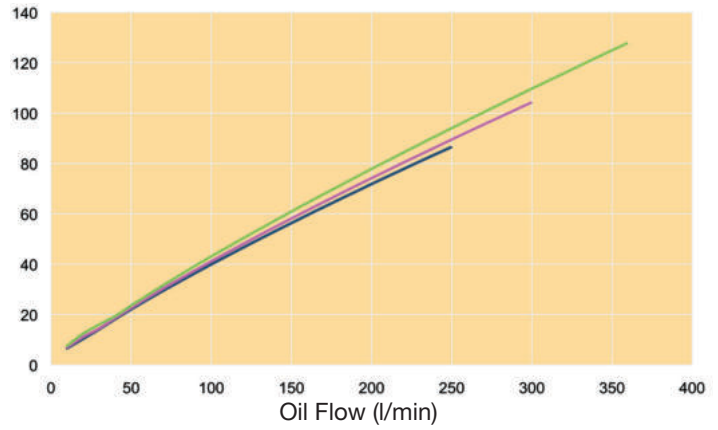
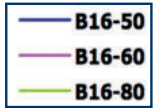

**Pressure Drop (bar)  
 B16**

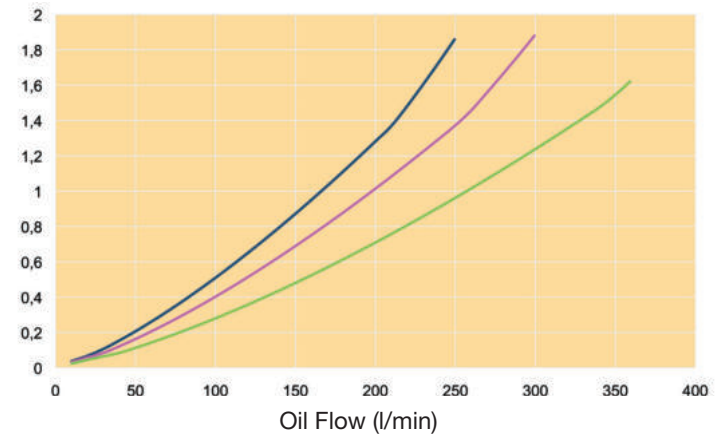
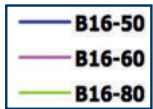

**Heat Load (kW)  
 B28**

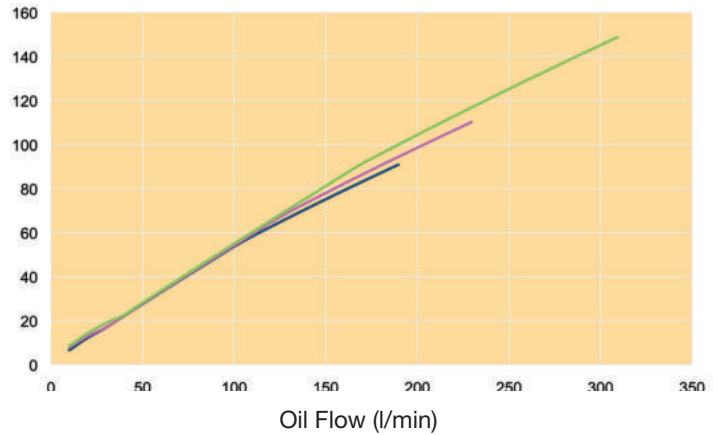

**Pressure Drop (bar)  
 B28**

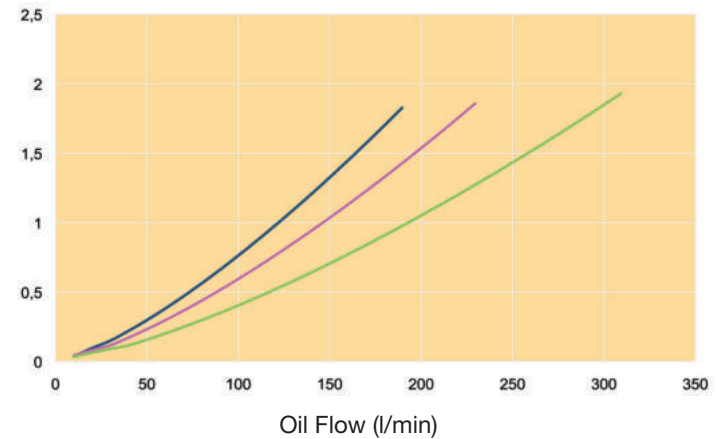
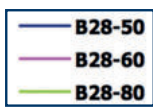



Oil type: ISO VG 46  
 Oil/water flow ratio: 2/1

Inlet oil temperature 60°C at  $\Delta p$  max 2 bar  
 Inlet water temperature 20°C

**Heat Load (kW)  
 B35**

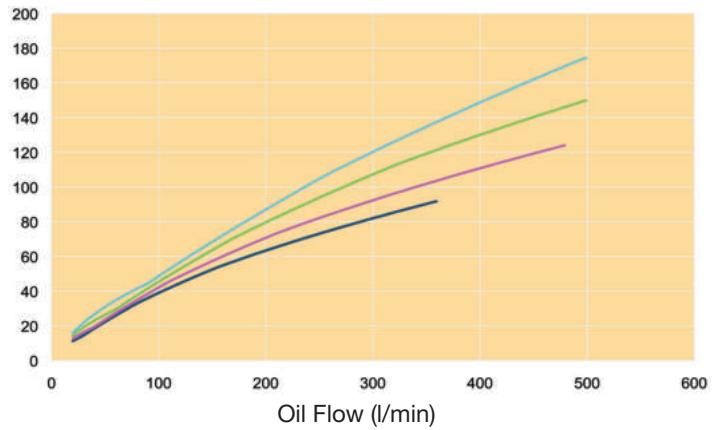
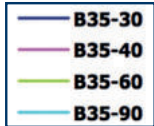

**Pressure Drop (bar)  
 B35**

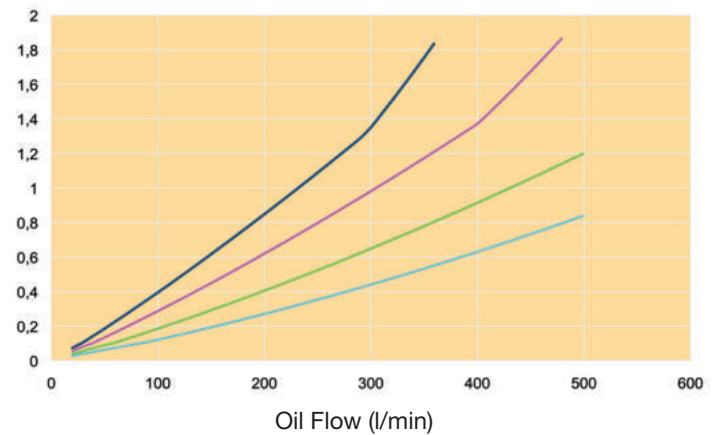
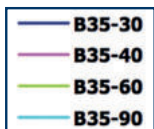

**Heat Load (kW)  
 B120T**

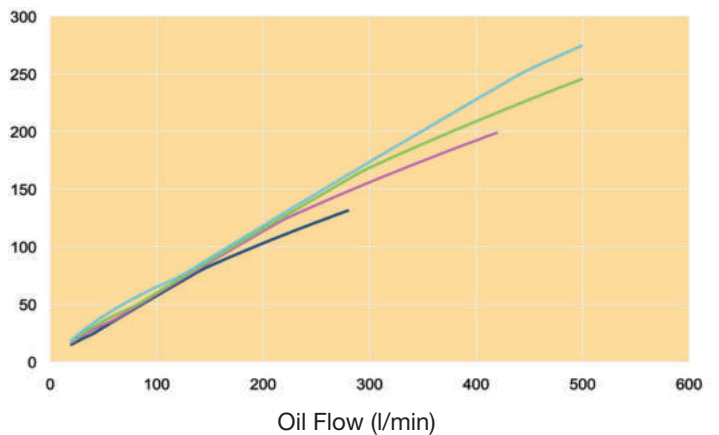
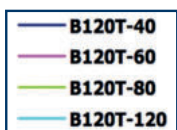

**Pressure Drop (bar)  
 B120T**

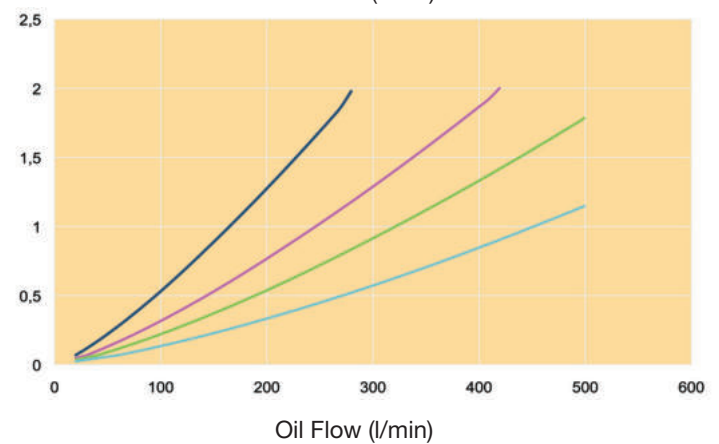
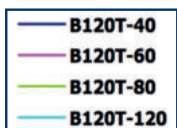



Oil type: ISO VG 46  
 Oil/water flow ratio: 2/1

Inlet oil temperature 60°C at  $\Delta p$  max 2 bar  
 Inlet water temperature 20°C

**Heat Load (kW)  
 B56**

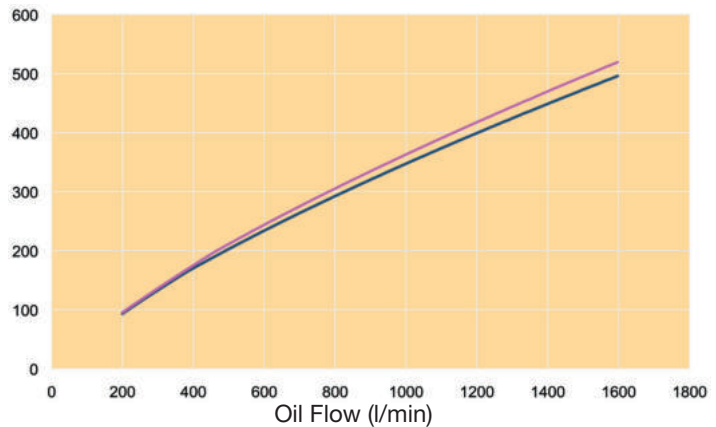
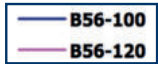

**Pressure Drop (bar)  
 B56**

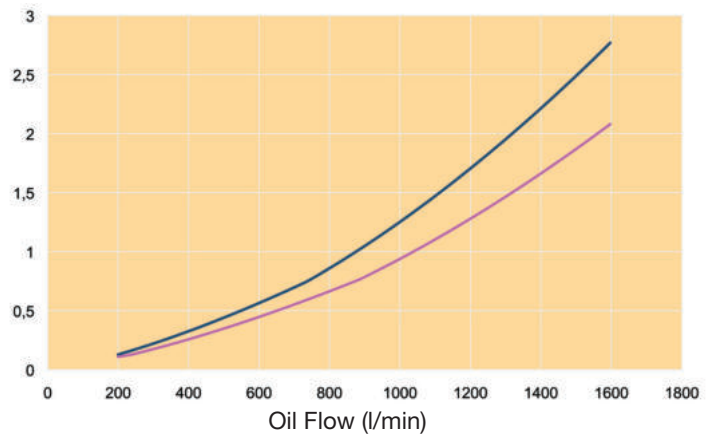

## A lot more than excellent coolers

Together we review all conditions – the water/oil cooler performance, the working environment, the type of fluid to be cooled, etc. Because of our deep knowledge and long experience, we can build on previous solutions and discuss all feasible solutions. All information will be entered into the calculation software, which will quickly and accurately show the most adequate solution. It is a simple

and easily accessible aid, which based on given parameters will select the most adequate cooler with regard to function and economy. The software can be downloaded for free from [www.parker.com/acde](http://www.parker.com/acde). Our technicians are also at your disposal if you have any inquiries about the software and its use.



**PWO Standard Range** of water oil coolers is available in a wide number of sizes and is in general available for immediate off-the-shelf delivery. The basic material is AISI 316 stainless steel, vacuum brazed with pure copper. The PWO requires only a small refrigerant volume resulting in lower cost and a more environmentally-friendly installation. Low installation cost allows for oversizing to accommodate for future increase in requirements or peak loads.

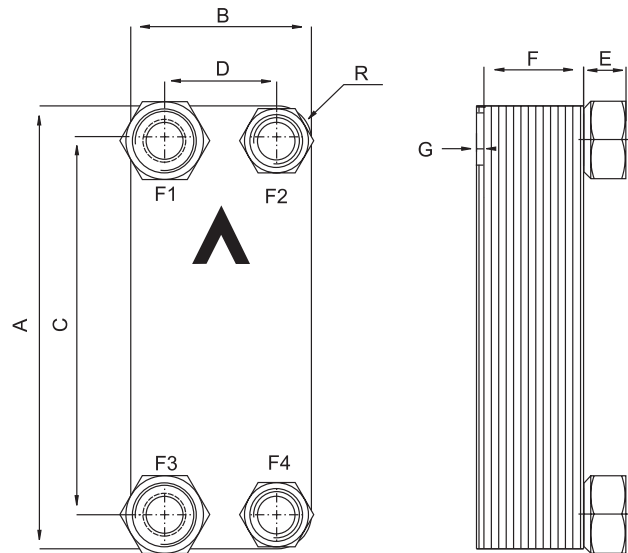

TYPE	A mm (±2)	B mm (±1)	C mm (±1)	D mm (±1)	E mm (±1) (+0.5% - 1.5%)	F * = x number of plates (±1)	G mm	R mm
B5T	193	76	154	40	20.1 2x3/4" - 2x1/2"	2.24 x * + 4	7	18
B8T	317	76	278	40	20.1 2x3/4" - 2x1/2"	2.24 x * + 4	7	18
B10T	289	119	243	72	20.1 2x1" - 2x3/4"	2.24 x * + 4	6	22
B12H	287	117	234	63	27.1 2x1 1/4" - 2x1"	2.24 x * + 4	6	22
B15	465	72	432	40	20.1 2x3/4" - 2x1/2"	2.24 x * + 4	7	16
B16	376	119	320	63	27.1 2x1 1/4" - 2x1 1/4"	2.24 x * + 4	6	23
B25T	526	119	479	72	20.1 2x1 1/4" - 2x1"	2.24 x * + 4	6	23
B28	526	119	470	63	27.1 2x1 1/4" - 2x1 1/4"	2.24 x * + 4	6	23
B35	393	243	324	174	27.1 2x1 1/2" - 2x1 1/4"	2.34 x * + 8	3	35
B56	525	243	430	148	54.2 ISO G 4x 2 1/2"	2.44 x * + 14	3	48
B120T	525	243	456	174	27.1 2x1 1/2" - 2x1 1/4"	2.29 x * + 10	4	35

Units size >B35-90 should always be fixed with two clamps per cooler >B35-90

Clamp Part Number	A	B
PWOCLAMPB5	219	90
PWOCLAMPB8	346	90
PWOCLAMPB10B12	319	135
PWOCLAMPB15	496	90
PWOCLAMPB16B26	408	135
PWOCLAMPB25B28	554	135
PWOCLAMPB35	422	259
PWOCLAMPB50B120	554	259

Vibration damper A30x15 M8x20 is available separately with Parker Part Number 214025

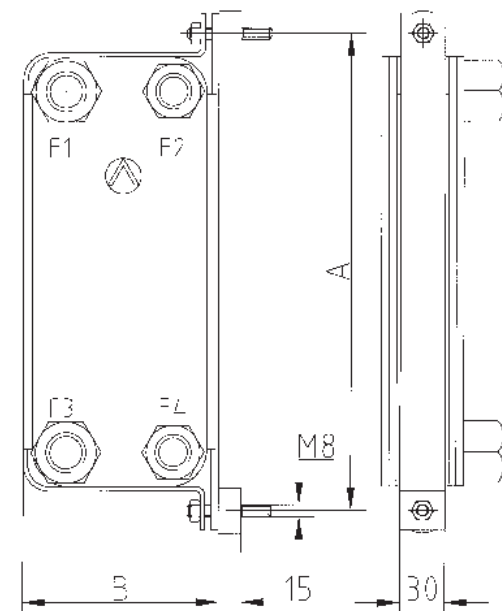



**B5T**  
Dimensions  
76 x 193 mm



**B8T**  
Dimensions  
76 x 317 mm



**B10T**  
Dimensions  
119x 289 mm



**B12H**  
Dimensions  
117 x 287 mm



**B15**  
Dimensions  
72 x 465 mm



**B16**  
Dimensions  
119 x 376 mm



**B25T**  
Dimensions  
119 x 526 mm



**B28**  
Dimensions  
119 x 526 mm

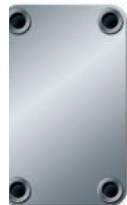

**B35**  
Dimensions  
243 x 393 mm



**B56**  
Dimensions  
243 x 525 mm



**B120T**  
Dimensions  
243 x 525 mm

TYPE	Max Temp °C	Min Temp °C	Working Pressure 155 °C bar	Test Pressure bar	Empty Weight kg * = number of plates
B5T	225	-196	31	50	0.50 + NoP* x 0.05
B8T	225	-196	31	50	0.81 + NoP* x 0.08
B10T	225	-196	31	50	1.39 + NoP* x 0.10
B12H	225	-196	28	45	1.44 + NoP* x 0.12
B15	225	-196	31	50	1.31 + NoP* x 0.10
B16	225	-196	31	50	1.73 + NoP* x 0.12
B25T	225	-196	31	50	2.15 + NoP* x 0.18
B28	225	-196	28	45	2.26 + NoP* x 0.16
B35	225	-196	31	50	6.99 + NoP* x 0.34
B56	225	-196	28	45	16.27 + NoP* x 0.42
B120T	225	-196	31	50	10.27 + NoP* x 0.40

**Material:**

Plates: EN 10028/7-1.4401 (AISI 316)

Brazing: Pure copper

Connections: EN 10272-1.4401 (AISI 316)



# Parker Worldwide

## Europe, Middle East, Africa

### AE – United Arab Emirates, Dubai

Tel: +971 4 8127100  
parker.me@parker.com

### AT – Austria, Wiener Neustadt

Tel: +43 (0)2622 23501-0  
parker.austria@parker.com

### AT – Eastern Europe, Wiener Neustadt

Tel: +43 (0)2622 23501 900  
parker.easteurope@parker.com

### AZ – Azerbaijan, Baku

Tel: +994 50 2233 458  
parker.azerbaijan@parker.com

### BE/LU – Belgium, Nivelles

Tel: +32 (0)67 280 900  
parker.belgium@parker.com

### BG – Bulgaria, Sofia

Tel: +359 2 980 1344  
parker.bulgaria@parker.com

### BY – Belarus, Minsk

Tel: +48 (0)22 573 24 00  
parker.poland@parker.com

### CH – Switzerland, Etoy

Tel: +41 (0)21 821 87 00  
parker.switzerland@parker.com

### CZ – Czech Republic, Klecany

Tel: +420 284 083 111  
parker.czechrepublic@parker.com

### DE – Germany, Kaarst

Tel: +49 (0)2131 4016 0  
parker.germany@parker.com

### DK – Denmark, Ballerup

Tel: +45 43 56 04 00  
parker.denmark@parker.com

### ES – Spain, Madrid

Tel: +34 902 330 001  
parker.spain@parker.com

### FI – Finland, Vantaa

Tel: +358 (0)20 753 2500  
parker.finland@parker.com

### FR – France, Contamine s/Arve

Tel: +33 (0)4 50 25 80 25  
parker.france@parker.com

### GR – Greece, Athens

Tel: +30 210 933 6450  
parker.greece@parker.com

### HU – Hungary, Budaörs

Tel: +36 23 885 470  
parker.hungary@parker.com

### IE – Ireland, Dublin

Tel: +353 (0)1 466 6370  
parker.ireland@parker.com

### IL – Israel

Tel: +39 02 45 19 21  
parker.israel@parker.com

### IT – Italy, Corsico (MI)

Tel: +39 02 45 19 21  
parker.italy@parker.com

### KZ – Kazakhstan, Almaty

Tel: +7 7273 561 000  
parker.easteurope@parker.com

### NL – The Netherlands, Oldenzaal

Tel: +31 (0)541 585 000  
parker.nl@parker.com

### NO – Norway, Asker

Tel: +47 66 75 34 00  
parker.norway@parker.com

### PL – Poland, Warsaw

Tel: +48 (0)22 573 24 00  
parker.poland@parker.com

### PT – Portugal

Tel: +351 22 999 7360  
parker.portugal@parker.com

### RO – Romania, Bucharest

Tel: +40 21 252 1382  
parker.romania@parker.com

### RU – Russia, Moscow

Tel: +7 495 645-2156  
parker.russia@parker.com

### SE – Sweden, Spånga

Tel: +46 (0)8 59 79 50 00  
parker.sweden@parker.com

### SK – Slovakia, Banská Bystrica

Tel: +421 484 162 252  
parker.slovakia@parker.com

### SL – Slovenia, Novo Mesto

Tel: +386 7 337 6650  
parker.slovenia@parker.com

### TR – Turkey, Istanbul

Tel: +90 216 4997081  
parker.turkey@parker.com

### UA – Ukraine, Kiev

Tel: +48 (0)22 573 24 00  
parker.poland@parker.com

### UK – United Kingdom, Warwick

Tel: +44 (0)1926 317 878  
parker.uk@parker.com

### ZA – South Africa, Kempton Park

Tel: +27 (0)11 961 0700  
parker.southafrica@parker.com

## North America

### CA – Canada, Milton, Ontario

Tel: +1 905 693 3000

### US – USA, Cleveland

Tel: +1 216 896 3000

## Asia Pacific

### AU – Australia, Castle Hill

Tel: +61 (0)2-9634 7777

### CN – China, Shanghai

Tel: +86 21 2899 5000

### HK – Hong Kong

Tel: +852 2428 8008

### IN – India, Mumbai

Tel: +91 22 6513 7081-85

### JP – Japan, Tokyo

Tel: +81 (0)3 6408 3901

### KR – South Korea, Seoul

Tel: +82 2 559 0400

### MY – Malaysia, Shah Alam

Tel: +60 3 7849 0800

### NZ – New Zealand, Mt Wellington

Tel: +64 9 574 1744

### SG – Singapore

Tel: +65 6887 6300

### TH – Thailand, Bangkok

Tel: +662 186 7000

### TW – Taiwan, Taipei

Tel: +886 2 2298 8987

## South America

### AR – Argentina, Buenos Aires

Tel: +54 3327 44 4129

### BR – Brazil, Sao Jose dos Campos

Tel: +55 800 727 5374

### CL – Chile, Santiago

Tel: +56 2 623 1216

### MX – Mexico, Toluca

Tel: +52 72 2275 4200

### EMEA Product Information Centre

Free phone: 00 800 27 27 5374

(from AT, BE, CH, CZ, DE, DK, EE, ES, FI, FR, IE, IL, IS, IT, LU, MT, NL, NO, PL, PT, RU, SE, SK, UK, ZA)

### US Product Information Centre

Toll-free number: 1-800-27 27 537

www.parker.com

